

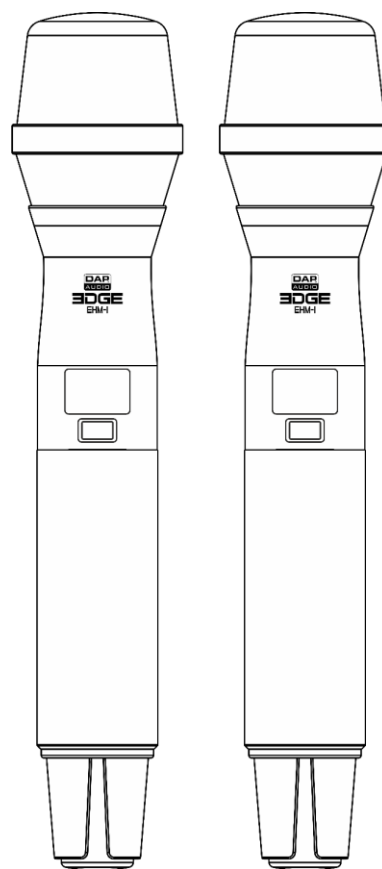

# USER MANUAL

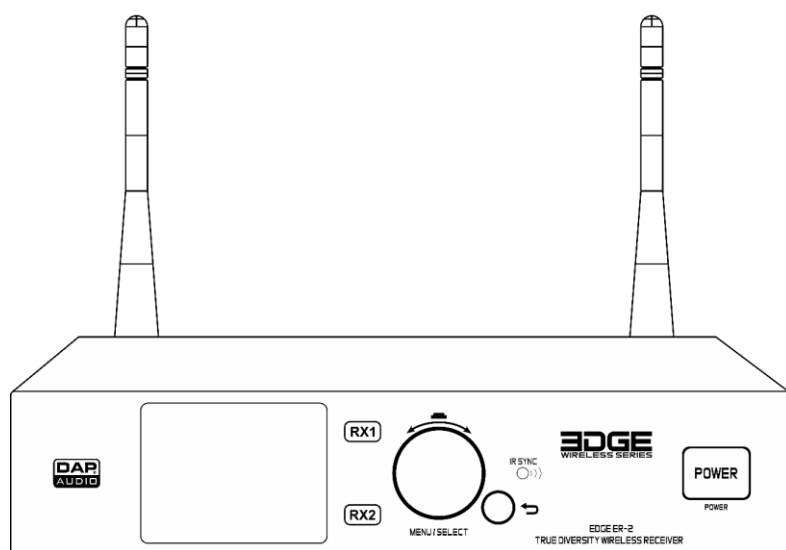

ENGLISH

## EDGE EHS-2

## V1

Product code: D1479B

## Preface

---

Thank you for purchasing this DAP product.

The purpose of this user manual is to provide instructions for the correct and safe use of this product.

Keep the user manual for future reference as it is an integral part of the product. The user manual shall be stored at an easily accessible location.

This user manual contains information concerning:

- Safety instructions
- Installation and operation of the device
- Intended and non-intended use of the device
- Maintenance procedures
- Troubleshooting
- Transport, storage and disposal of the device

Non-observance of the instructions in this user manual may result in serious injuries and damage of property.

©2023 DAP. All rights reserved.

No part of this document may be copied, published or otherwise reproduced without the prior written consent of Highlite International.

Design and product specifications are subject to change without prior notice.

For the latest version of this document or other language versions, please visit our website [www.highlite.com](http://www.highlite.com) or contact us at [service@highlite.com](mailto:service@highlite.com).

Highlite International and its authorized service providers are not liable for any injury, damage, direct or indirect loss, consequential or economic loss or any other loss arising from the use of, or inability to use or reliance on the information contained in this document.

## Table of contents

<b>1. Introduction</b> .....	<b>4</b>
1.1. Before Using the Product .....	4
1.2. Intended Use .....	4
1.3. Product Lifespan.....	4
1.4. Text Conventions .....	4
1.5. Symbols and Signal Words.....	5
1.6. Symbols on the Information Label .....	5
<b>2. Safety</b> .....	<b>6</b>
2.1. Warnings and Safety Instructions .....	6
2.2. Requirements for the User.....	7
<b>3. Description of the Device</b> .....	<b>8</b>
3.1. Receiver – Front View .....	8
3.2. Receiver – Back View .....	8
3.3. Microphone (Handheld Transmitter) .....	9
3.4. Product Specifications .....	10
3.5. Optional Accessories.....	11
3.6. Dimensions.....	12
<b>4. Installation and Setup</b> .....	<b>13</b>
4.1. Ambient Conditions .....	13
4.2. Installation.....	13
4.2.1. Single Receiver .....	13
4.2.2. Two Receivers .....	14
4.3. Setup.....	15
4.3.1. Installation of the Antennas.....	15
4.3.2. Connecting to Power Supply .....	16
4.3.2.1. Power Linking of Multiple Devices.....	16
4.3.3. Setup Example .....	17
4.3.4. Connecting the Receiver to Mixer/Amplifier .....	18
4.3.5. Switching ON/OFF – Receiver .....	18
4.3.6. Installation of the Batteries .....	19
4.3.7. Switching ON/OFF – Transmitter.....	20
4.3.8. Pairing.....	20
<b>5. Operation</b> .....	<b>20</b>
5.1. Safety Instructions for Operation .....	20
5.2. Operation .....	21
5.3. Control Panel – Receiver .....	21
5.3.1. Main Menu Options .....	22
5.3.1.1. Group .....	23
5.3.1.2. Channel .....	23
5.3.1.3. Frequency.....	23
5.3.1.4. Scan .....	24
5.3.1.5. Synchronization .....	24
5.3.1.6. Lock.....	25
5.3.1.7. Transmitter Gain.....	25
5.3.1.8. Receiver Gain .....	26
5.3.1.9. Low Cut .....	26
5.3.1.10. Squelch .....	27
5.3.1.11. Tone Key .....	27
5.3.1.12. Color .....	28
5.3.1.13. Name.....	28
5.4. Control Panel – Transmitter.....	29
5.4.1. Mute.....	29
5.4.2. Main Menu Options .....	29
5.4.2.1. Group .....	30
5.4.2.2. Channel .....	30

- 5.4.2.3. Frequency.....30
- 5.4.2.4. Gain .....31
- 5.4.2.5. RF Output Power .....31
- 5.4.2.6. Lock.....32
- 5.5. Channel and Frequency Overview .....33
- 6. Troubleshooting .....34**
- 6.1. Adjusting the Microphone Gain .....34
- 7. Maintenance .....35**
- 7.1. Preventive Maintenance .....35
- 7.1.1. Basic Cleaning Instructions .....35
- 7.2. Corrective Maintenance .....35
- 8. Deinstallation, Transportation and Storage .....35**
- 9. Disposal .....36**
- 10. Approval.....36**

## 1. Introduction

### 1.1. Before Using the Product



**Important**  
Read and follow the instructions in this user manual before installing, operating or servicing this product.

The manufacturer will not accept liability for any resulting damages caused by the non-observance of this manual.

After unpacking, check the contents of the box. If any parts are missing or damaged, contact your Highlite International dealer.

Your shipment includes:

- DAP EDGE EHS-2 (receiver + 2 x transmitter)
- 2 x antenna
- AC power adapter (1,4 m)
- 2 x windshield cap
- Leather bag
- Microphone stickers
- User manual

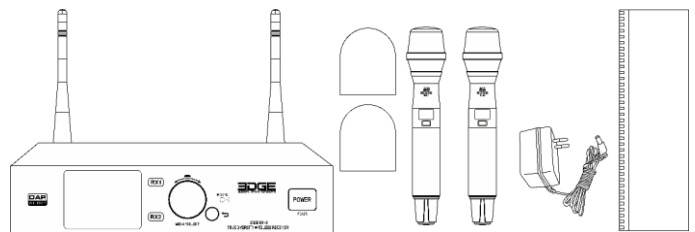

Mounting kit:

- Long mounting bracket
- Short mounting bracket
- Mounting plate
- 4 x mounting screw for the device
- 4 x mounting screw for the 19-inch rack

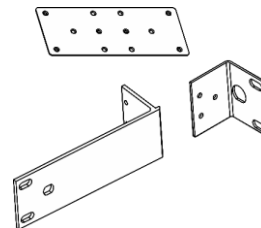

Fig. 01

### 1.2. Intended Use

This device is intended for use as a wireless microphone system. It is suitable only for indoor installation.

Any other use, not mentioned under intended use, is regarded as non-intended and incorrect use.

### 1.3. Product Lifespan

This device is not designed for permanent operation. Disconnect the device from the electrical power supply when the device is not in operation. This will reduce the wear and will improve the device's lifespan.

### 1.4. Text Conventions

Throughout the user manual the following text conventions are used:

- Buttons: All buttons are in bold lettering, for example "Press the **UP/DOWN** buttons"
- References: References to chapters and parts of the device are in bold lettering, for example: "Refer to **2. Safety**", "press the **power switch (03)**"
- 0–255: Defines a range of values
- Notes: **Note:** (in bold lettering) is followed by useful information or tips

## 1.5. Symbols and Signal Words

Safety notes and warnings are indicated throughout the user manual by safety signs.

Always follow the instructions provided in this user manual.



### **DANGER**

Indicates an imminently hazardous situation which, if not avoided, will result in death or serious injury.



### **WARNING**

Indicates an imminently hazardous situation which, if not avoided, could result in death or serious injury.



### **CAUTION**

Indicates a potentially hazardous situation, which, if not avoided, may result in minor or moderate injury.



### **Attention**

Indicates important information for the correct operation and use of the product.



### **Important**

Read and observe the instructions in this document.



Provides important information about the disposal of this product.



## 1.6. Symbols on the Information Label

This product is provided with an information label. The information label is located on the bottom plate of the device.

The information label contains the following symbols:



This device shall not be treated as household waste.



## 2. Safety



### Important

**Read and follow the instructions in this user manual before installing, operating or servicing this product.**

The manufacturer will not accept liability for any resulting damages caused by the non-observance of this manual.

### 2.1. Warnings and Safety Instructions



### DANGER

**Danger for children**

For adult use only. The device must be installed beyond the reach of children.

- Do not leave various parts of the packaging (plastic bags, polystyrene foam, nails, etc.) within children's reach. Packaging material is a potential source of danger for children.



### Attention

**Incorrect handling of the AC power adapter may result in hazardous situations**

This device is delivered with an AC power adapter. Incorrect handling of the AC power adapter may result in hazardous situations.

- Use only the AC power adapter delivered with the device.
- Do not wrap the power cable around the power adapter or any other object. This can damage the internal wires.
- Do not cover the power adapter with anything when it is plugged into the socket-outlet. This may cause overheating.
- Do not expose the power adapter to water or other liquids.

Do not use the power adapter:

- If it shows signs of overheating, for example the plastic is damaged
- If the AC input pins show signs of corrosion or overheating
- If the power cable is damaged or shows signs of material fatigue.



### Attention

**General safety**

- Do not shake the device. Avoid brute force when installing or operating the device.
- If the device is dropped or struck, disconnect the device from the electrical power supply immediately.
- If the device is exposed to extreme temperature variations (e.g. after transportation), do not switch it on immediately. Let the device reach room temperature before switching it on, otherwise it may be damaged by the formed condensation.
- If the device fails to work correctly, discontinue the use immediately.

**Attention**

**This device shall be used only for the purposes it is designed for.**

This device is designed to be used as a wireless microphone system. Any incorrect use may lead to hazardous situations and result in injuries and material damage.

- This device is not designed for permanent operation.
- This device does not contain user-serviceable parts. Unauthorized modifications to the device will render the warranty void. Such modifications may result in injuries and material damage.

**Attention**

**Do not expose the device to conditions that exceed the rated IP class conditions.**

This device is IP20 rated. IP (Ingress Protection) 20 class provides protection against solid objects greater than 12 mm, such as fingers, and no protection against harmful ingress of water.

## 2.2. Requirements for the User

This product may be used by ordinary persons. Maintenance and installation may be carried by ordinary persons. Service shall be carried out only by instructed or skilled persons. Contact your Highlite International dealer for more information.

Instructed persons have been instructed and trained by a skilled person, or are supervised by a skilled person, for specific tasks and work activities associated with the service of this product, so that they can identify risks and take precautions to avoid them.

Skilled persons have training or experience, which enables them to recognize risks and to avoid hazards associated with the service of this product.

Ordinary persons are all persons other than instructed persons and skilled persons. Ordinary persons include not only users of the product but also any other persons that may have access to the device or who may be in the vicinity of the device.

### 3. Description of the Device

The EDGE EHS-2 is a wireless handheld system. The set consists of 2 handheld transmitters and a receiver. The EDGE is suitable for voice transmission. The transmitters are powered by 2 x AA LR6 (alkaline) batteries (not included).

#### 3.1. Receiver – Front View

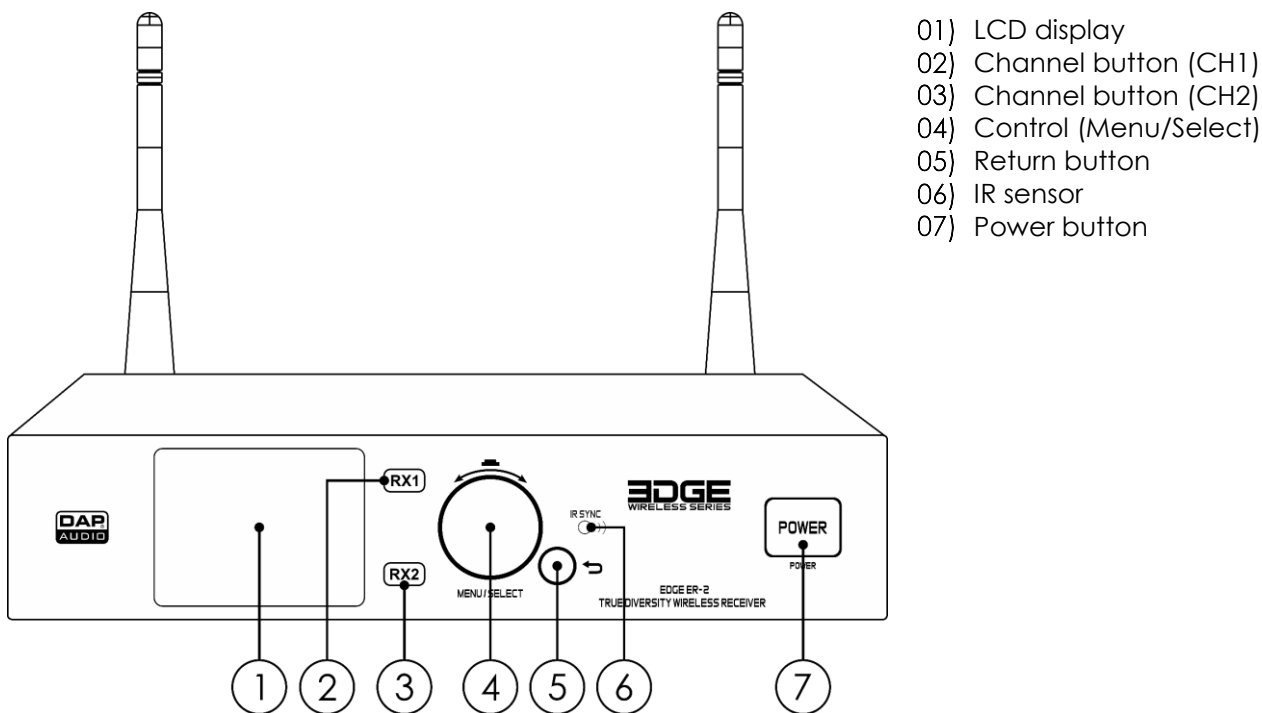

- 01) LCD display
- 02) Channel button (CH1)
- 03) Channel button (CH2)
- 04) Control (Menu/Select)
- 05) Return button
- 06) IR sensor
- 07) Power button

Fig. 02

#### 3.2. Receiver – Back View

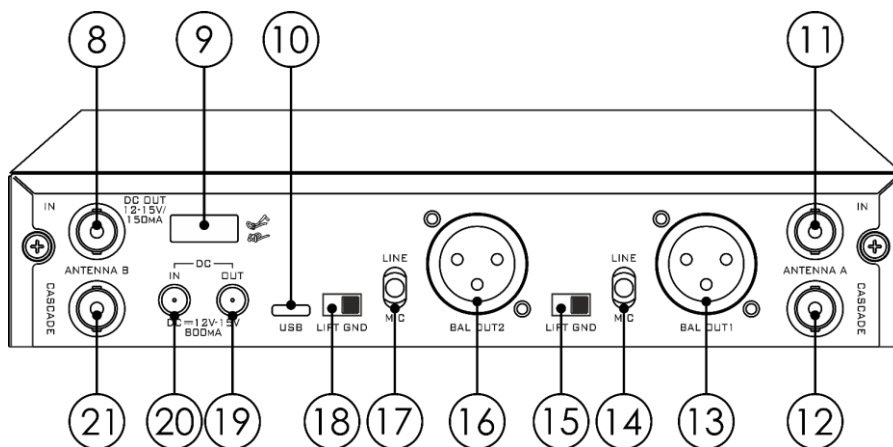

Fig. 03

- |  |   |
|--|---|
| 08) 12–15 V DC BNC connector (antenna B, 150 mA) | 15) Ground/lift switch (CH1)                |
| 09) Power cable safety eye                       | 16) 3-pin XLR AF balanced OUT (CH2)         |
| 10) USB C connector (for firmware updates)       | 17) Mic/line switch (CH2)                   |
| 11) 12–15 V DC BNC connector (antenna A, 150 mA) | 18) Ground/lift switch (CH2)                |
| 12) 12–15 V DC BNC cascade connector             | 19) 12–15 V DC power connector OUT (800 mA) |
| 13) 3-pin XLR AF balanced OUT (CH1)              | 20) 12–15 V DC power connector IN (800 mA)  |
| 14) Mic/line switch (CH1)                        | 21) 12–15 V DC BNC cascade connector        |

### 3.3. Microphone (Handheld Transmitter)

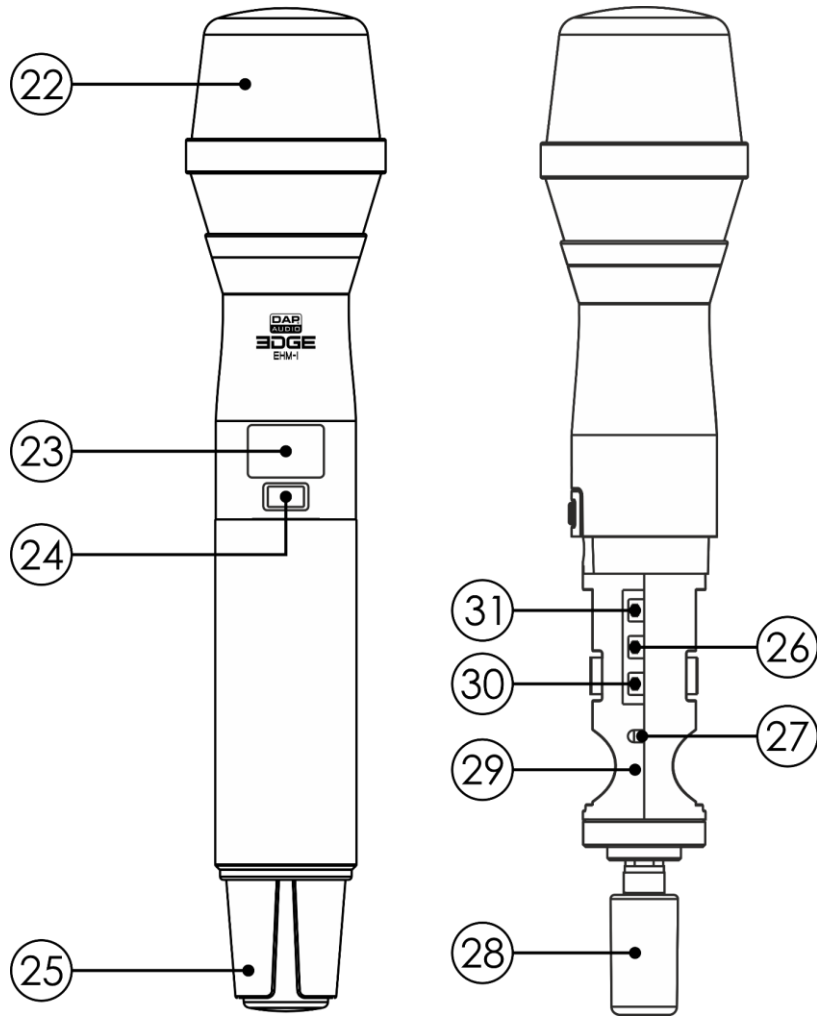

Fig. 04

- 22) Microphone head
- 23) OLED display
- 24) Power button (on/off)
- 25) Battery cover
- 26) DOWN button

- 27) IR sensor
- 28) Transmitter antenna
- 29) Battery housing (2 x AA LR6)
- 30) SET button
- 31) UP button

### 3.4. Product Specifications

Model:	EDGE EHS-2
--------	------------

#### Receiver

##### Electrical:

Input voltage:	100–240 V AC, 50/60 Hz
Output voltage:	12–15 V DC
Power consumption:	7,8 W

##### AC power adapter:

Input voltage:	100–240 V AC, 50/60 Hz
Output voltage:	15 V DC

##### Physical:

Dimensions:	205 x 225 x 44,5 mm (L x W x H), 1U
Installation depth:	220 mm
Weight:	1,25 kg

##### Audio specifications:

Frequency range:	610–668 MHz
Wireless stability:	0,0015 %
RF bandwidth:	60 MHz
THD level:	< 1,0 %
Signal-to-noise ratio:	> 100 dB
RF antenna input impedance:	50 $\Omega$
Max. balanced audio output:	48 dBu
Receiver output impedance:	50 $\Omega$
RF receiver antenna output voltage:	15 V
RF receiver antenna output current:	150 mA

##### Connections:

Power connection:	DC connectors IN/OUT
Output connections:	2 x 3-pin XLR connector OUT, balanced
Input RF connections:	2 x BNC connector (RF antenna input) 2 x BNC connector (cascade)

##### Operation and control:

Receiver type:	True diversity
Display:	OLED

##### Construction:

Housing:	Aluminum/metal
Color:	Black
IP rating:	IP20

#### Transmitter

##### Physical:

Dimensions:	Ø51 mm x 255 mm (WxH)
Diameter:	36 mm
Weight:	0,38 kg

##### Audio specifications:

Microphone type:	Condenser
Sensitivity:	2,2 mV

Gain range:	30 dB
Polar pattern:	Cardioid
Frequency response:	60–18000 Hz
Maximum SPL:	130 dB
Frequency range:	610–668 MHz
Wireless stability:	0,0015 %
RF power:	30 mW
RF bandwidth:	60 MHz
Frequency deviation:	± 75 kHz
Spurious rejection:	≤ 50 dBC

**Operation and control:**

Display:	OLED
----------	------

**Construction:**

Housing:	Aluminum
Color:	Black

**Batteries:**

Batteries:	2 x AA LR6 (alkaline) 1,5 V (not included)
Average runtime:	10 h

**Thermal:**

Maximum ambient temperature $t_a$ :	50 °C
Minimum ambient temperature:	0 °C

### 3.5. Optional Accessories

You can additionally purchase the following accessories:

- [D1475B](#) (EDGE EHS-1, 1-channel wireless handheld system)
- [D1476B](#) (EDGE EBS-1, 1-channel wireless bodypack system)
- [D1477B](#) (EDGE EHM-1, handheld condenser microphone)
- [D1478B](#) (EDGE EBT-1, bodypack)
- [D1480B](#) (EDGE EBS-2, 2-channel wireless bodypack system)
- [D1486](#) (EDGE EUA-1, set of 2 unidirectional antennas)
- [D1487](#) (EDGE EOA-1, set of 2 omnidirectional antennas)

### 3.6. Dimensions

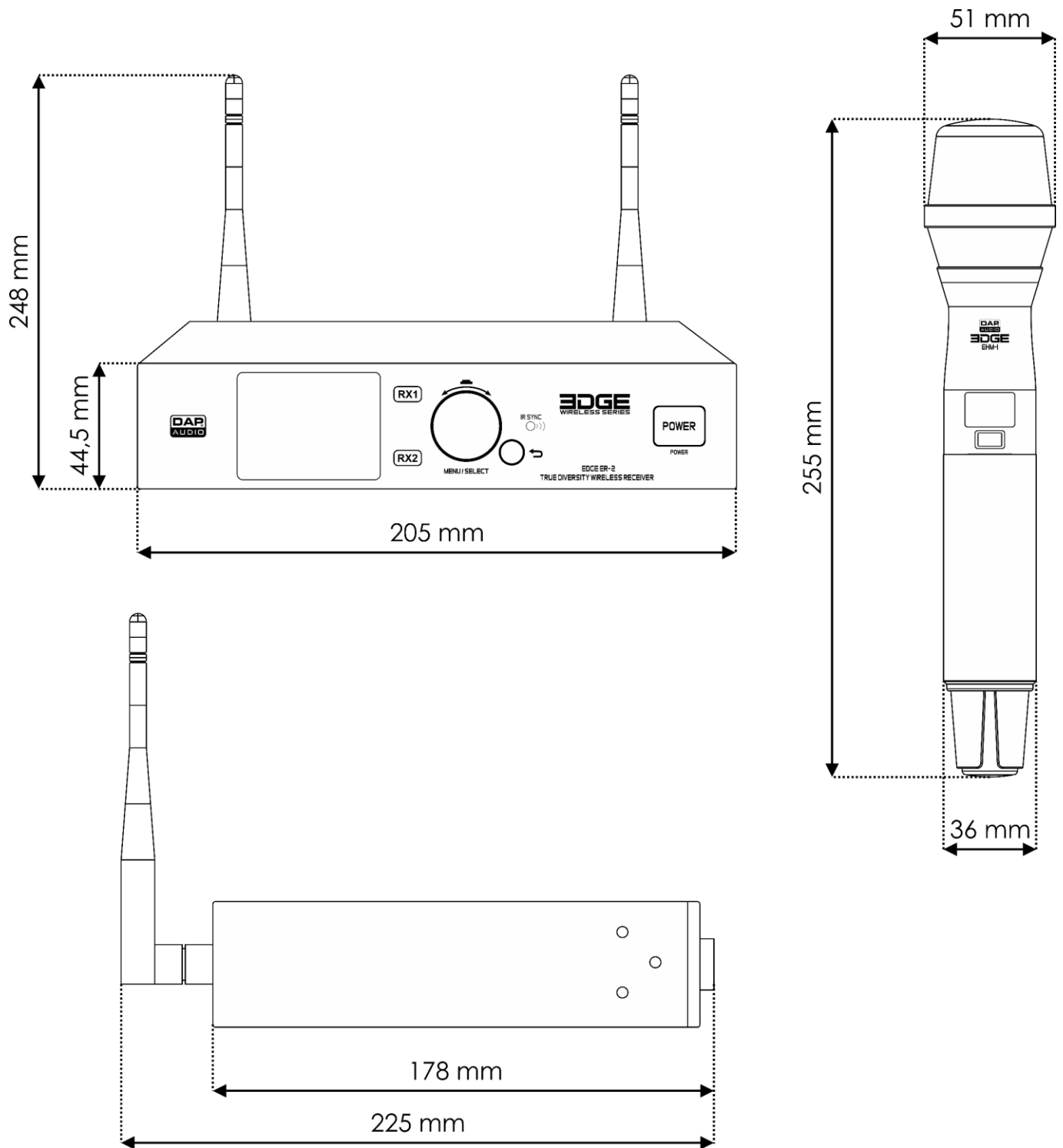

Fig. 05

## 4. Installation and Setup

### 4.1. Ambient Conditions

- The device can be used only indoors.
- The maximum ambient temperature  $t_a = 50\text{ °C}$  must never be exceeded.
- The relative humidity must not exceed 50 % with an ambient temperature of 50 °C.

### 4.2. Installation

The receiver can be put on a stable, flat surface, or can be mounted in a standard 19-inch rack. The receiver requires 1 rack unit (U) of space, which is 44,45 mm high. Make sure that the rack is sufficiently secured to prevent it from becoming unstable or falling over.

The device is supplied with 2 mounting brackets and mounting screws. It is possible to mount a single or two receivers in a 19-inch rack.

To mount the receiver, you need a Phillips screwdriver.

To mount the receiver in a two-post rack, follow the steps below:

- 01) Attach the mounting brackets and/or the mounting plate to the receiver(s). See **4.2.1. Single Receiver** or **4.2.2. Two Receivers** on pages 13–14 for more information.
- 02) Insert 4 cage nuts in the openings on the rack posts where you want to mount the receiver(s).
- 03) Position the receiver(s) in front of the rack posts so that the 4 x mounting openings on the mounting brackets face the openings on the rack posts with cage nuts.
- 04) Use a screwdriver to mount the receiver(s) to the rack posts with 4 screws.

#### 4.2.1. Single Receiver

Attach the supplied long and short mounting brackets with the mounting screws to the receiver.

Use a Philips screwdriver to tighten the mounting screws.

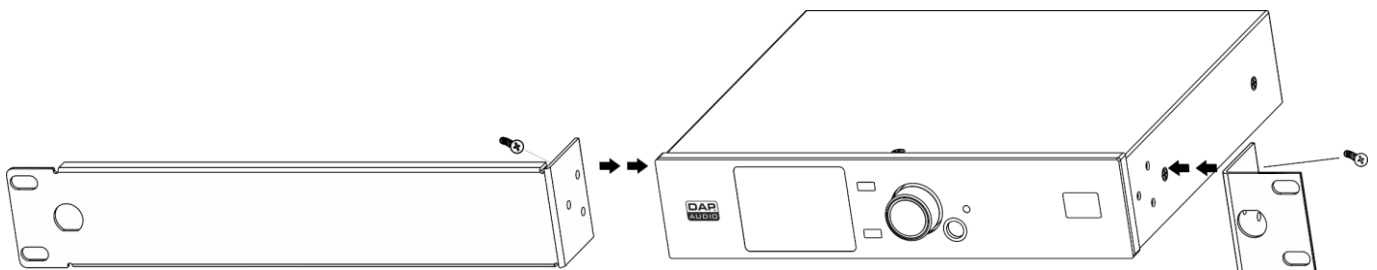

Fig. 06

#### 4.2.2. Two Receivers

- 01) Attach the supplied short mounting brackets with the mounting screws to the receivers. Use a Phillips screwdriver to tighten the mounting screws.

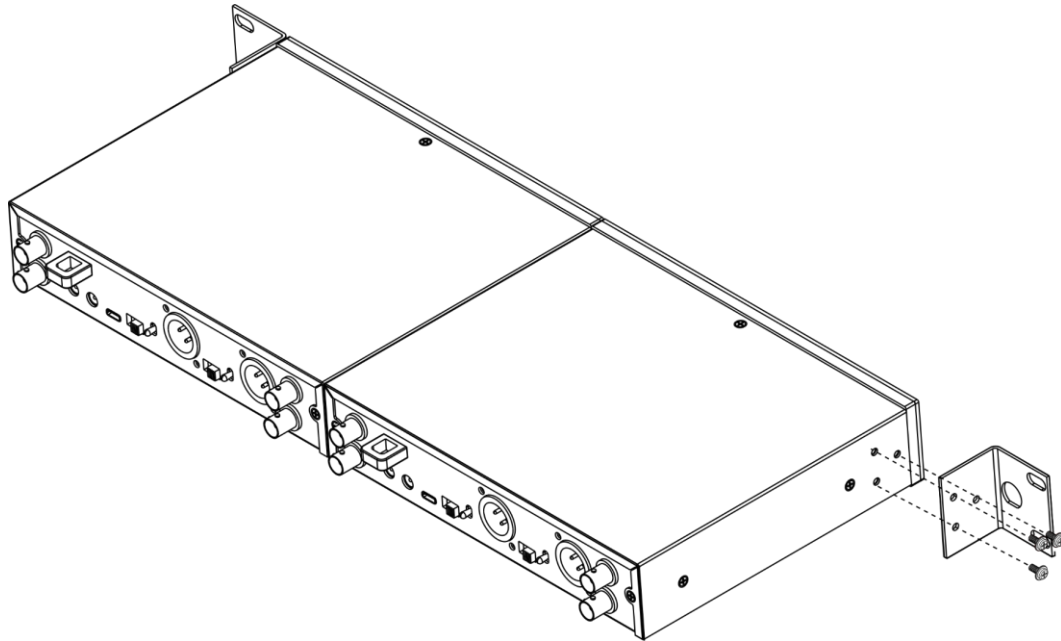

Fig. 07

- 02) Attach the supplied mounting plate with the mounting screws to the bottom of both receivers. Use a Phillips screwdriver to tighten the mounting screws.

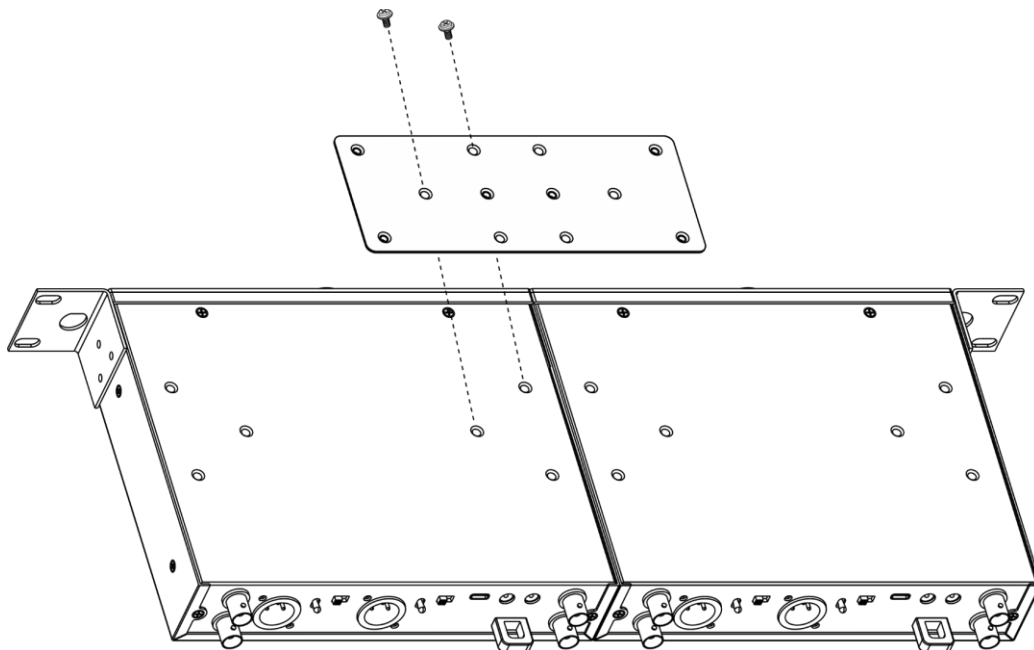

Fig. 08

### 4.3. Setup



**Attention**  
 Connect all data cables before supplying power.  
 Disconnect power supply before connecting or disconnecting data cables.

To set up the wireless handheld system, follow the steps below:

- 01) Install the antennas. See **4.3.1. Installation of the Antennas** on page 15.
- 02) Connect the receiver to power supply. See **4.3.2. Connecting to Power Supply** and **4.3.2.1. Power Linking of Multiple Devices** on page 16.
- 03) Connect other EDGE devices to the receiver(s). See **4.3.3. Setup Example** on page 17.
- 04) Connect a mixer/amplifier to the receiver(s). See **4.3.4. Connecting the Receiver to Mixer/Amplifier** on page 18.
- 05) Switch on the receiver. See **4.3.5. Switching ON/OFF - Receiver** on page 18.
- 06) Install the batteries in the transmitter. See **4.3.6. Installation of the Batteries** on page 19.
- 07) Switch on the transmitter. See **4.3.7. Switching ON/OFF - Transmitter** on page 20.
- 08) Pair the transmitter with the receiver. See **4.3.8. Pairing** on page 20.
- 09) Switch on the connected mixer/amplifier.

#### 4.3.1. Installation of the Antennas

The device is delivered with 2 antennas. The antennas are not connected. To install the antennas:

- 01) Insert the 1<sup>st</sup> antenna into the **12–15 V DC BNC connector (08)**.
- 02) Insert the 2<sup>nd</sup> antenna into **12–15 V DC BNC connector (11)**.
- 03) Point the antennas away from each other at an angle of 45° (Fig. 09).

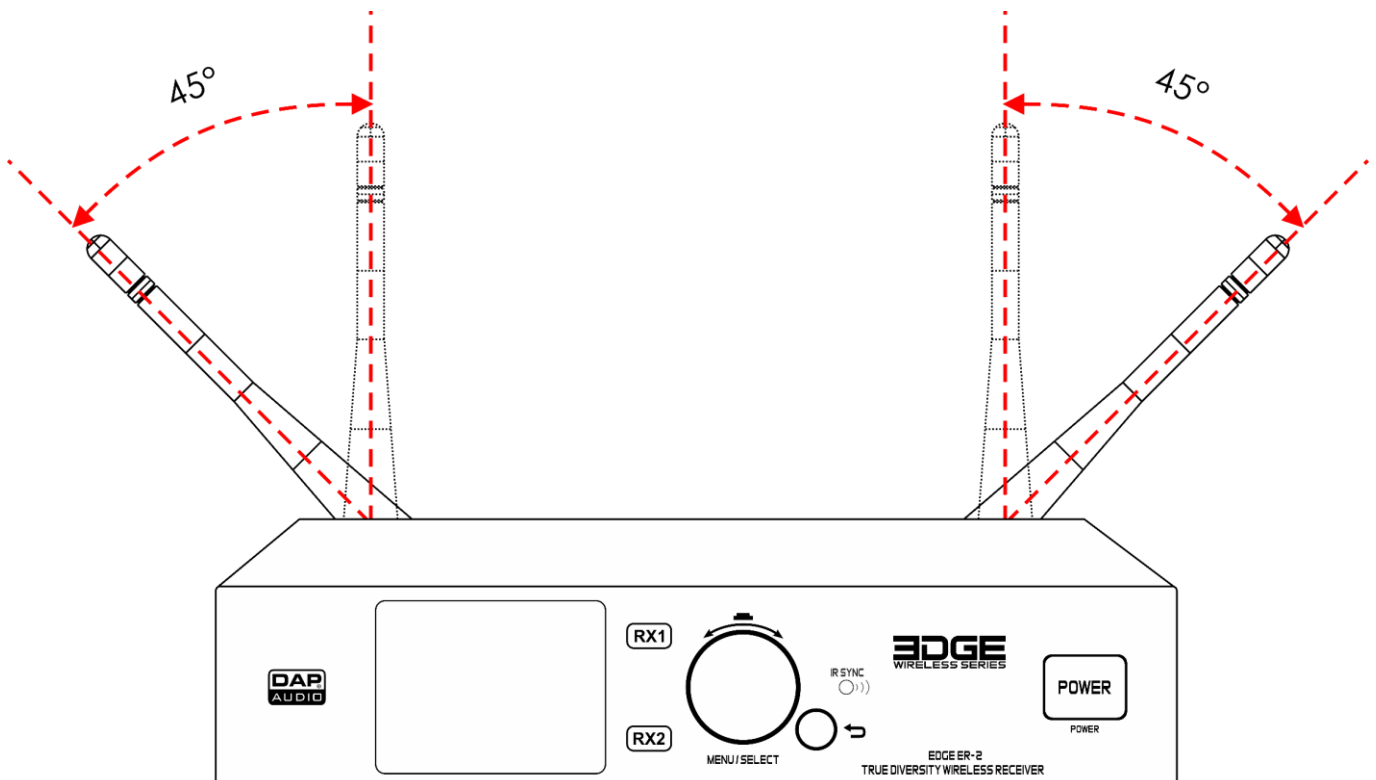

Fig. 09

#### Note:

- Do not use the antennas near metal surfaces or other obstructions.
- Make sure that the antennas do not cross when multiple wireless systems are used.

### 4.3.2. Connecting to Power Supply



**Attention**  
**Incorrect handling of the AC power adapter may result in hazardous situations**

This device is delivered with an AC power adapter. Incorrect handling of the AC power adapter may result in hazardous situations.

- Connect the receiver to the socket-outlet with the delivered AC power adapter. Use only the AC power adapter delivered with the device.
- Make sure that the socket-outlet is easily accessible.
- Disconnect the AC power adapter from the socket-outlet when the device is not in use.

#### 4.3.2.1. Power Linking of Multiple Devices

This receiver supports power linking. Power can be relayed to another receiver via the **12–15 V DC power connector OUT (19)**.

Power linking of multiple devices must be carried out only by instructed or skilled persons.

To prevent overload of the electrical circuit, when power linking multiple devices:

- Use cables with sufficient current-carrying capacity. The power adapter supplied with the device is not suitable for power linking of multiple devices.
- Make sure that the total current draw of the device and all connected devices does not exceed the rated capacity of the power adapter, power cables and the circuit breaker.
- Do not link more devices on one power link than the maximum recommended number.

4.3.3. Setup Example

It is possible to connect up to 8 receivers and 16 transmitters and to install accessories. See 3.5. **Optional Accessories** on page 11 for more information.

The unidirectional/omnidirectional antennas receive the signal from the transmitter(s) and send it to the first receiver. The first receiver sends the signal to the other connected receivers.

Connect the **12-15 V DC BNC cascade connectors (12/21)** of the first receiver to the **12-15 V DC BNC cascade connectors (08/11)** of the second receiver. Repeat this step to connect multiple receivers as shown in Fig. 10.

The unidirectional/omnidirectional antennas are not supplied with the device. See 3.5. **Optional Accessories** on page 11.

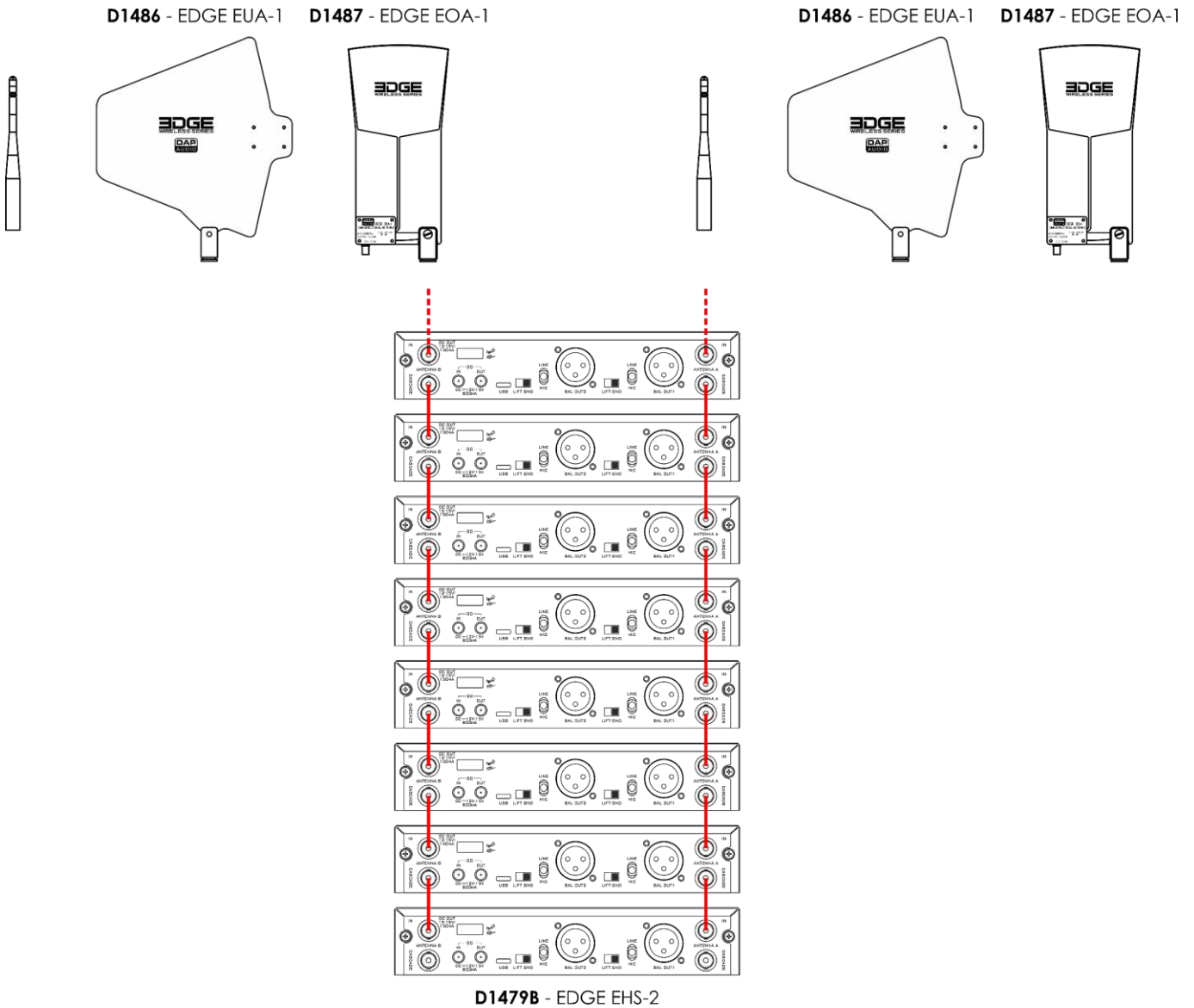

Fig. 10

#### 4.3.4. Connecting the Receiver to Mixer/Amplifier

**Attention**

**Connect all data cables before supplying power.**

**Disconnect power supply before connecting or disconnecting data cables.**

The receiver has 2 balanced 3-pin XLR output connectors.

To connect the receiver to a mixer or an amplifier:

- 01) Make sure that the receiver is not connected to power supply and the volume is turned down.
- 02) Make sure that the mixer or the amplifier are switched off and the volume is turned down.
- 03) Use a 3-pin XLR audio cable to connect the **3-pin XLR AF balanced OUT (13/16)** of the receiver to the XLR input connector of the mixer/amplifier.

#### 4.3.5. Switching ON/OFF – Receiver

The receiver has a power button.

- Press and hold down the **power button (07)** for 2 seconds to switch on the receiver. The **LCD display (01)** lights up.
- Press and hold down the **power button (07)** for 2 seconds to switch off the receiver. The receiver remains energized.

**Note:**

The mains plug is used as a disconnect device. Disconnect the AC power adapter from the socket-outlet to disconnect the receiver from the power supply.

#### 4.3.6. Installation of the Batteries

The transmitters are delivered without batteries. The transmitters accept 2 x AA LR6 (alkaline) batteries.

To install the batteries:

- 01) Turn the **battery cover (25)** counterclockwise to remove it.
- 02) Insert the batteries into the **battery housing (29)** (Fig. 11). The transmitter operates with 2 x AA LR6 (alkaline) batteries. The batteries are not delivered with the product.
- 03) Install the **battery cover (25)** again on the transmitter. Do not overtighten.

**Note:**

Make sure that you install the batteries with correct polarity orientation.

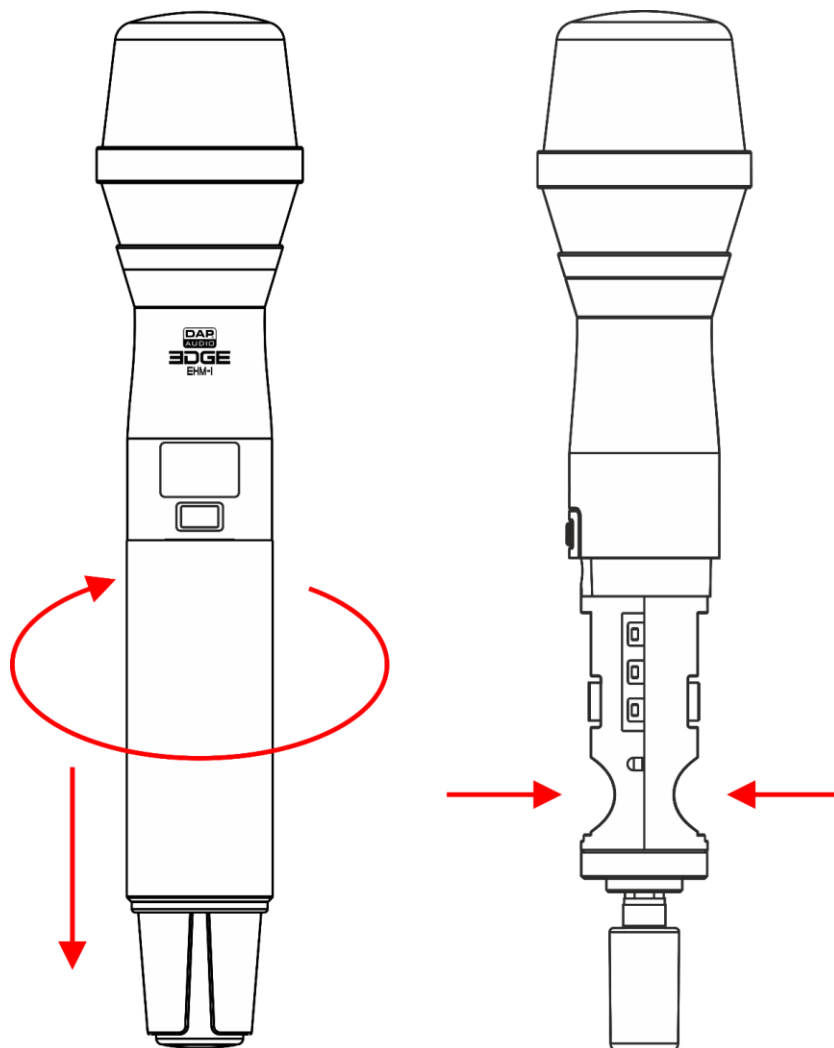

Fig. 11

### 4.3.7. Switching ON/OFF – Transmitter

The transmitter has a power button.

- Press and hold down the **power button (24)** for 3 seconds to switch the transmitter on/off.
- When in the main menu of the transmitter, press the **power button (24)** to confirm selections and to return to the start screen.

### 4.3.8. Pairing

You can pair the transmitter with the receiver.

Before pairing, scan for unused frequencies to avoid interference. See **5.3.1.4. Scan** on page 24.

To automatically pair the receiver with the transmitter, follow the steps below:

- 01) Remove the **battery cover (25)** of the transmitter.
- 02) Put the transmitter near the receiver, so that the **IR sensor (27)** of the transmitter is as close as possible to the **IR sensor (06)** of the receiver.
- 03) Follow the steps in **5.3.1.5. Synchronization** on page 24.
- 04) Install the **battery cover (25)** again on the transmitter.

To manually set the transmitter and the receiver to the same channel and frequency, follow the steps below:

- 01) Select a group on the receiver. See **5.3.1.1. Group** on page 23.
- 02) Select a channel on the receiver. See **5.3.1.2. Channel** on page 23.
- 03) Select a frequency on the receiver. See **5.3.1.3. Frequency** on page 23.
- 04) Select a group on the transmitter. See **5.4.2.1. Group** on page 30.
- 05) Select a channel on the transmitter. See **5.4.2.2. Channel** on page 30.
- 06) Select a frequency on the transmitter. See **5.4.2.3. Frequency** on page 30.

## 5. Operation

### 5.1. Safety Instructions for Operation



#### Attention

This device must be used only for the purposes it is designed for.

This device is intended for use as a wireless handheld system. It is suitable only for indoor installation. It is not suitable for households.

Any other use, not mentioned under intended use, is regarded as non-intended and incorrect use.



#### Attention

Power supply

Before connecting the device to the power supply, make sure that the current, voltage and frequency match the input voltage, current and frequency specified on the information label on the device.

## 5.2. Operation

To operate the device, talk or sing into the transmitter. The **AF signal strength (L)** indicator on the **LCD display (01)** increases or decreases during talking/singing. If the signal is too loud, "AF" and "P" of the **AF signal strength (L)** indicator flash red.

After use:

- 01) Mute the transmitter to prevent the occurrence of a popping sound. See **5.4.1. Mute** on page 29.
- 02) Switch off the receiver and the transmitter. See **4.3.5. Switching ON/OFF – Receiver** on page 18 and **4.3.7. Switching ON/OFF – Transmitter** on page 20.

## 5.3. Control Panel – Receiver

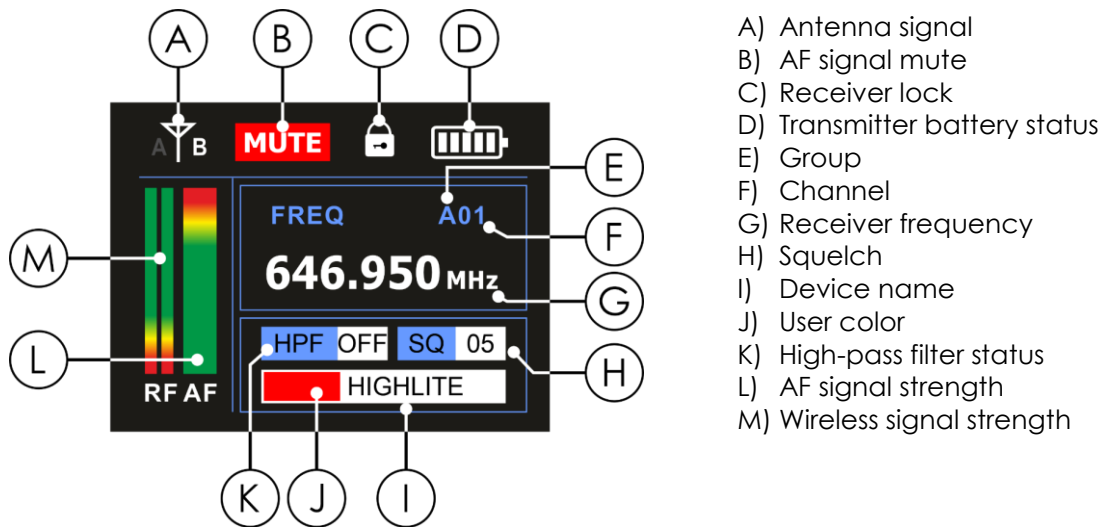
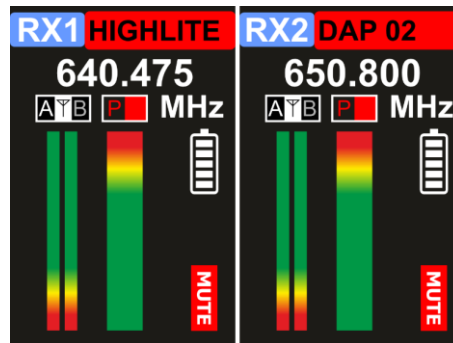

Fig. 12

- Press the **control (04)** to open a menu and to confirm a selection.
- Turn the **control (04)** to navigate through the menus and to increase/decrease values.
- Press the **return button (05)** to cancel a selection and to return to a previous screen.

### 5.3.1. Main Menu Options

Upon start-up, the display shows the DAP logo. After 2 seconds, the display shows the overview of both channels.



- 01) Press one of the **channel buttons (02/03)** to view the current status of the selected channel. The display shows:

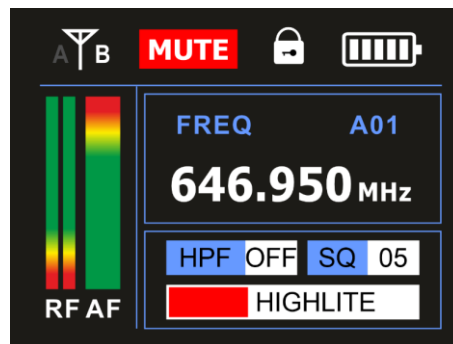

- 02) Press the **control (04)** to open the main menu. The display shows:

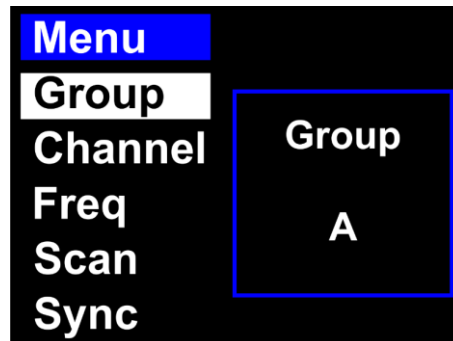

- 03) Turn the **control (04)** to toggle through the following 13 options:

- GROUP: See **5.3.1.1. Group**
- CHANNEL: See **5.3.1.2. Channel**
- FREQ: See **5.3.1.3. Frequency**
- SCAN: See **5.3.1.4. Scan**
- SYNC: See **5.3.1.5. Synchronization**
- LOCK: See **5.3.1.6. Lock**
- TX GAIN: See **5.3.1.7. Transmitter Gain**
- RX GAIN: See **5.3.1.8. Receiver Gain**
- LOW CUT: See **5.3.1.9. Low Cut**
- SQUELCH: See **5.3.1.10. Squelch**
- TONE KEY: See **5.3.1.11. Tone Key**
- COLOR: See **5.3.1.12. Color**
- NAME: See **5.3.1.13. Name**

- 04) Press the **control (04)** to open menus.

### 5.3.1.1. Group

In this menu you can select a group. Each group (A–J) has a unique set of channels with 14 fixed frequencies per channel. See **5.5. Channel and Frequency Overview** on page 33.

01) Turn the **control (04)** to select GROUP.

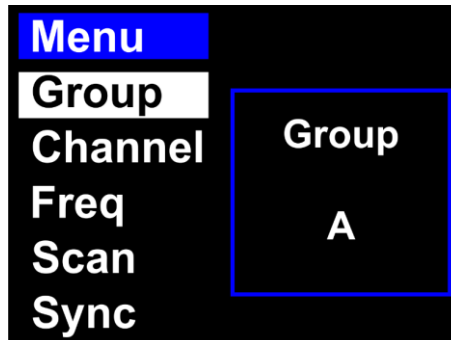

02) Press the **control (04)** to edit.

03) Turn the **control (04)** to select a group. The adjustment range is A–J.

04) Press the **control (04)** to confirm.

### 5.3.1.2. Channel

In this menu you can select a channel. Each channel (1–14) has a unique fixed frequency. See **5.5. Channel and Frequency Overview** on page 33.

01) Turn the **control (04)** to select CHANNEL.

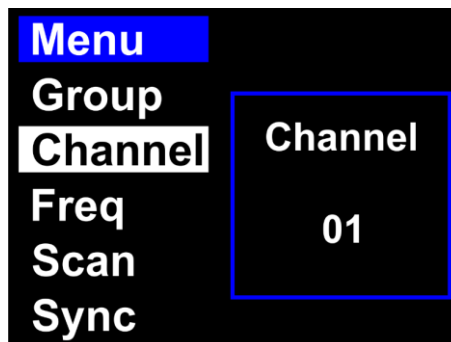

02) Press the **control (04)** to edit.

03) Turn the **control (04)** to select a channel. The adjustment range is 1–14.

04) Press the **control (04)** to confirm.

### 5.3.1.3. Frequency

In this menu you can set the frequency. See **5.5. Channel and Frequency Overview** on page 33.

01) Turn the **control (04)** to select FREQ.

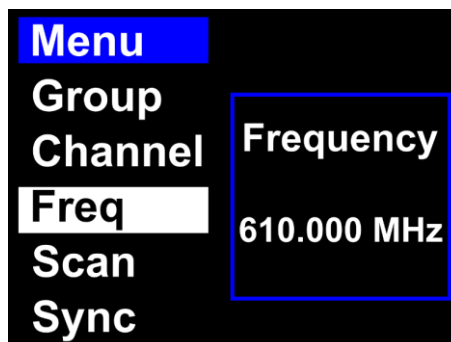

02) Press the **control (04)** to edit.

03) Turn the **control (04)** to select a frequency. The adjustment range is between 610–668 MHz.

04) Press the **control (04)** to confirm.

### 5.3.1.4. Scan

In this menu you can automatically scan the entire frequency range, to find the unused frequencies and avoid interference.

01) Turn the **control (04)** to select SCAN.

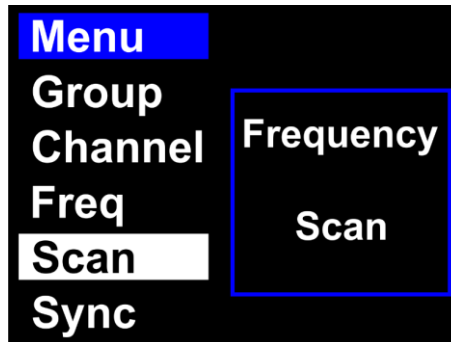

02) Press the **control (04)** to scan the entire frequency range (610–668 MHz). This process may take up to 2 minutes. Once the scan is finished, you can see which frequencies are already in use and which are not.

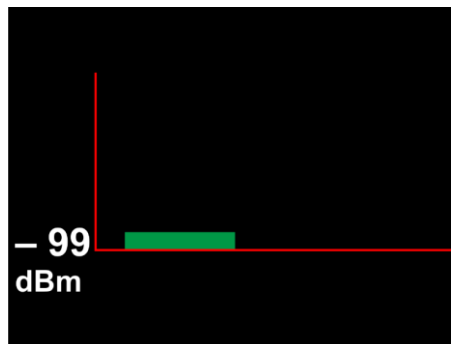

03) Press the **control (04)** to return to the main menu.

### 5.3.1.5. Synchronization

In this menu you can pair the receiver with the transmitter.

01) Turn the **control (04)** to select SYNC.

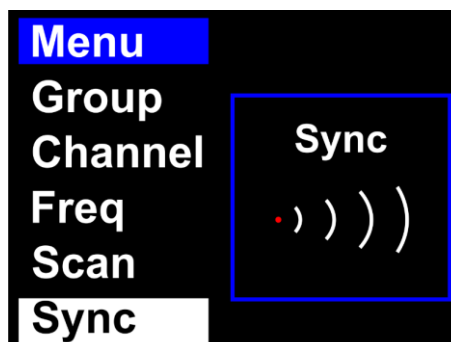

02) Press the **control (04)** to pair the devices. The LED of the **IR sensor (06)** of the receiver blinks several times. The devices are now paired and ready for use.

### 5.3.1.6. Lock

In this menu you can lock the display of the receiver.

01) Turn the **control (04)** to select LOCK.

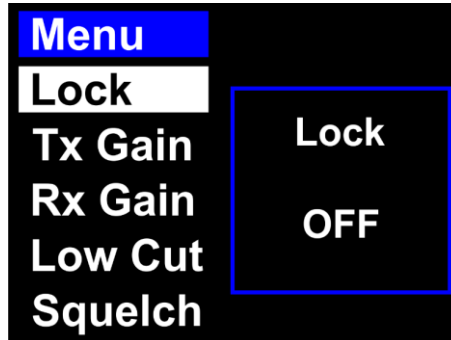

02) Press the **control (04)** to edit.

03) Turn the **control (04)** to select one of the 2 options:

- ON: The display is locked
- OFF: The display is unlocked

04) Press the **control (04)** to confirm.

#### Note:

To unlock the display, press and hold down the **control (04)** for 4 seconds, until the **receiver lock (C)** disappears from the display.

#### Note:

The display does not lock automatically. It can be locked only manually.

### 5.3.1.7. Transmitter Gain

In this menu you can set the gain of the transmitter (input sensitivity).

01) Turn the **control (04)** to select TX GAIN.

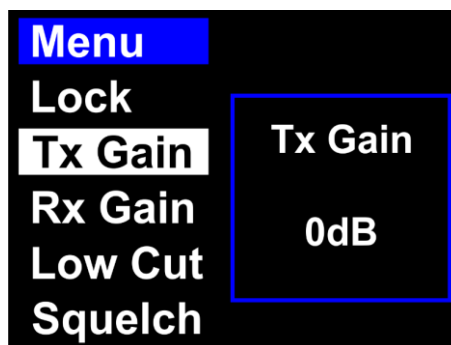

02) Press the **control (04)** to edit.

03) Turn the **control (04)** to set the gain. The adjustment range is from -32 dB to +4 dB.

04) Press the **control (04)** to confirm.

### 5.3.1.8. Receiver Gain

In this menu you can set the output gain of the receiver.

01) Turn the **control (04)** to select RX GAIN.

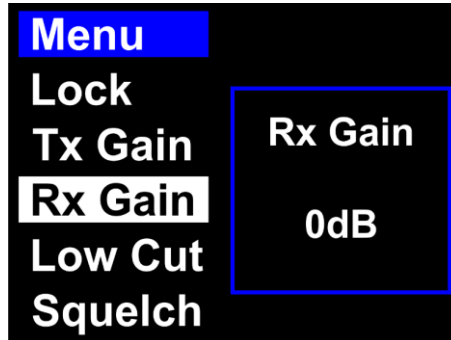

02) Press the **control (04)** to edit.

03) Turn the **control (04)** to set the output gain. The adjustment range is from -32 dB to +4 dB.

04) Press the **control (04)** to confirm.

### 5.3.1.9. Low Cut

In this menu you can set the low-cut filter. The low-cut filter removes low-frequency signals picked up by the transmitter.

01) Turn the **control (04)** to select LOW CUT.



02) Press the **control (04)** to edit.

03) Turn the **control (04)** to select one of the 2 options:

- ON: Low-cut filter on
- OFF: Low-cut filter off

04) Press the **control (04)** to confirm.

### 5.3.1.10. Squelch

In this menu you can set the squelch threshold. The squelch threshold is pre-set at the factory and normally needs no further adjustment. In case the receiver picks up other signals besides the signal of the transmitter, follow the steps bellow. To eliminate the interference, increase the squelch threshold for the respective channel.

01) Turn the **control (04)** to select SQUELCH.

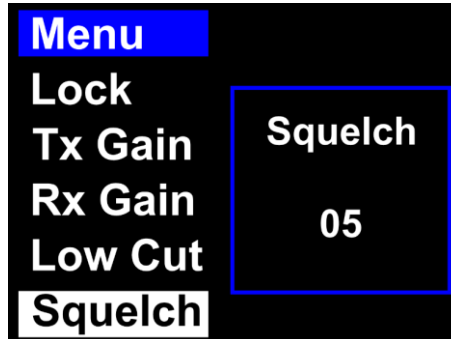

02) Press the **control (04)** to edit.

03) Turn the **control (04)** to set the value. The adjustment range is 1–10.

04) Press the **control (04)** to confirm.

#### Note:

Increasing the squelch threshold decreases the transmission range, which may cause loss of signal from the transmitter. Always adjust the squelch control to the lowest possible setting.

### 5.3.1.11. Tone Key

In this menu you can set the tone key. The receiver uses it to identify the transmitter and its battery status.

01) Turn the **control (04)** to select TONEKEY.

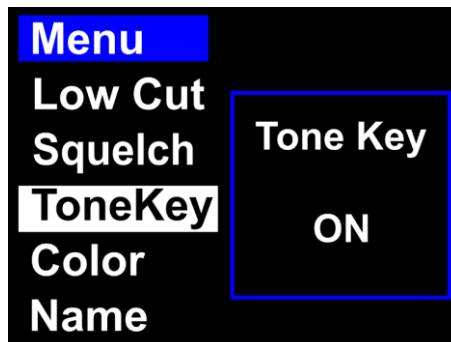

02) Press the **control (04)** to edit.

03) Turn the **control (04)** to select one of the 2 options:

- ON: Tone key is on
- OFF: Tone key is off

04) Press the **control (04)** to confirm.

### 5.3.1.12. Color

In this menu you can assign a color to the transmitter. It is useful when working with multiple receivers and transmitters. Put a sticker with the correct color on your transmitter. The stickers are supplied with the device.

01) Turn the **control (04)** to select COLOR.

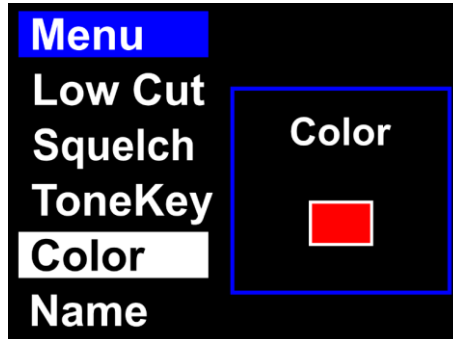

02) Press the **control (04)** to edit.

03) Turn the **control (04)** to select one of the 8 colors (red, yellow, green, blue, orange, brown, white, black).

04) Press the **control (04)** to confirm.

### 5.3.1.13. Name

In this menu you can set the name of the receiver. A name can consist of up to 8 characters.

01) Turn the **control (04)** to select NAME.

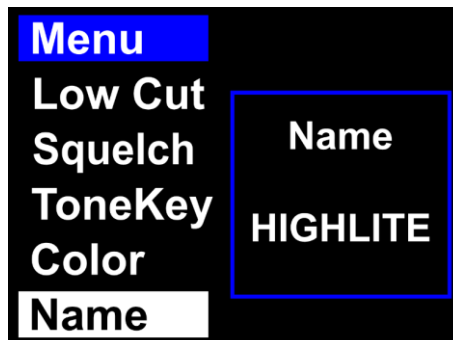

02) Press the **control (04)** to edit. The currently selected character will be highlighted.

03) Turn the **control (04)** to change the character. The available characters are lowercase and uppercase letters, digits, punctuation marks, and some symbols.

04) Press the **control (04)** to confirm.

05) Repeat steps 3–4 to edit the remaining characters.

## 5.4. Control Panel – Transmitter

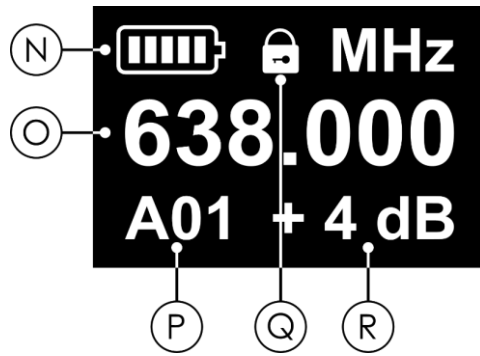

- N) Transmitter battery status
- O) Frequency
- P) Group (A–J) and channel (1–14)
- Q) Transmitter lock
- R) Gain level

Fig. 13

- Press the **SET button (30)** to open a menu and to confirm a selection.
- Press the **UP/DOWN buttons (31/26)** to navigate through the options or to increase/decrease values.

### 5.4.1. Mute

During operation you can mute the transmitter with the **power button (24)**.

- Press the **power button (24)** to mute the transmitter.
- Press the **power button (24)** again to deactivate mute.

### 5.4.2. Main Menu Options

Upon start-up, the display shows the current status of the transmitter.



01) Press the **SET button (30)** to open the main menu. The display shows:

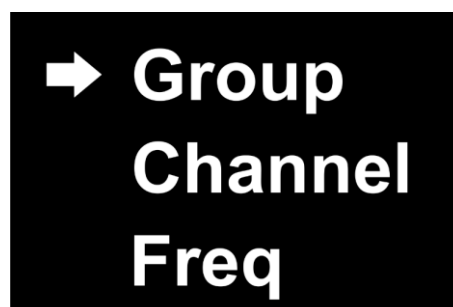

02) Press the **UP/DOWN buttons (31/26)** to select the following 6 options:

- GROUP See **5.4.2.1. Group**
- CHANNEL See **5.4.2.2. Channel**
- FREQ See **5.4.2.3. Frequency**
- GAIN See **5.4.2.4. Gain**
- RF POWER See **5.4.2.5. RF Output Power**
- LOCK See **5.4.2.6. Lock**

03) Press the **SET button (30)** to open menus.

### 5.4.2.1. Group

In this menu you can select a group. Each group (A–J) has a unique set of channels with 14 fixed frequencies per channel. See **5.5. Channel and Frequency Overview** on page 33.

01) Press the **UP/DOWN buttons (31/26)** to select GROUP.



02) Press the **SET button (30)** to edit.

03) Press the **UP/DOWN buttons (31/26)** to select a group. The adjustment range is A–J.

04) Press the **SET button (30)** to confirm.

### 5.4.2.2. Channel

In this menu you can select a channel. Each channel (1–14) has a unique fixed frequency. See **5.5. Channel and Frequency Overview** on page 33.

01) Press the **UP/DOWN buttons (31/26)** to select CHANNEL.

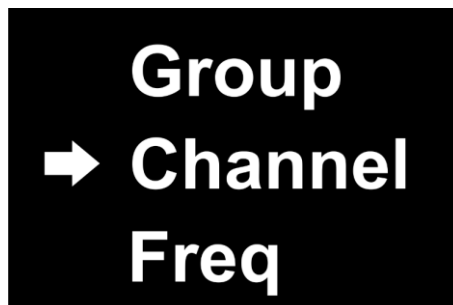

02) Press the **SET button (30)** to edit.

03) Press the **UP/DOWN buttons (31/26)** to select a channel. The adjustment range is 1–14.

04) Press the **SET button (30)** to confirm.

### 5.4.2.3. Frequency

In this menu you can set the frequency. See **5.5. Channel and Frequency Overview** on page 33.

01) Press the **UP/DOWN buttons (31/26)** to select FREQ.

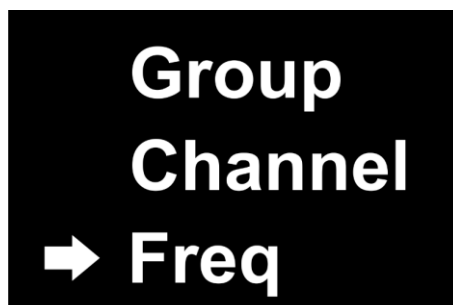

02) Press the **SET button (30)** to edit.

03) Press the **UP/DOWN buttons (31/26)** to select a frequency. The adjustment range is between 610–668 MHz.

04) Press the **SET button (30)** to confirm.

#### 5.4.2.4. Gain

In this menu you can set the gain of the transmitter.

01) Press the **UP/DOWN buttons (31/26)** to select GAIN.

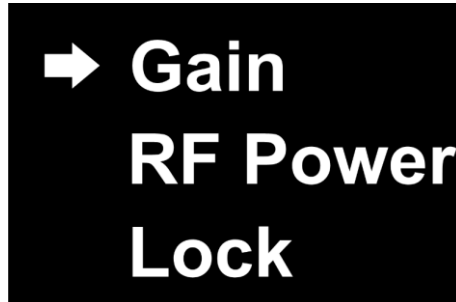

02) Press the **SET button (30)** to edit.

03) Press the **UP/DOWN buttons (31/26)** to set the desired gain. The adjustment range is from -32 dB to +4 dB.

04) Press the **SET button (30)** to confirm.

#### 5.4.2.5. RF Output Power

In this menu you can set the RF output power.

01) Press the **UP/DOWN buttons (31/26)** to select RF POWER:

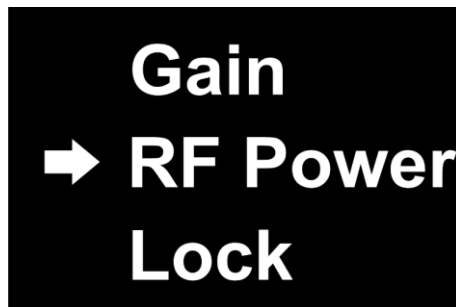

02) Press the **SET button (30)** to edit.

03) Press the **UP/DOWN buttons (31/26)** to select one of the 3 options:

- LOW (10 mW)
- MID (20 mW)
- HIGH (30 mW)

04) Press the **SET button (30)** to confirm.

#### Note:

The maximum allowed RF output power differs per country and region. Consult the respective national and/or regional authority as licensing or specific restrictions may apply for the use of the device. We do not take any responsibility in case the device cannot operate or cannot be used in your country/region or if it requires additional licensing. Before using the device, check the maximum allowed RF output power in your country or region.

#### 5.4.2.6. Lock

In this menu you can lock the display of the transmitter.

01) Press the **UP/DOWN buttons (31/26)** to select LOCK.

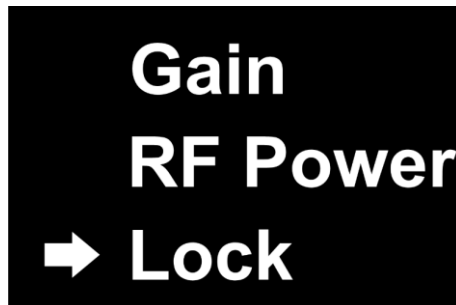

02) Press the **SET button (30)** to edit.

03) Press the **UP/DOWN buttons (31/26)** to select one of the 2 options:

- ON: The display is locked
- OFF: The display is unlocked

04) Press the **SET button (30)** to confirm.

#### Note:

To unlock the display, press and hold down the **SET button (30)** for 3 seconds, until the **transmitter lock (Q)** disappears from the display.

## 5.5. Channel and Frequency Overview

The carrier frequency is in the range 610–668 MHz.

A		B		C		D		E	
CH	Frequency	CH	Frequency	CH	Frequency	CH	Frequency	CH	Frequency
1	610.000 MHz	1	610.250 MHz	1	610.500 MHz	1	610.750 MHz	1	611.000 MHz
2	612.025 MHz	2	612.275 MHz	2	612.525 MHz	2	612.775 MHz	2	613.025 MHz
3	614.250 MHz	3	614.500 MHz	3	614.750 MHz	3	615.000 MHz	3	615.250 MHz
4	616.700 MHz	4	616.950 MHz	4	617.200 MHz	4	617.450 MHz	4	617.700 MHz
5	619.375 MHz	5	619.625 MHz	5	619.875 MHz	5	620.125 MHz	5	620.375 MHz
6	622.250 MHz	6	622.500 MHz	6	622.750 MHz	6	623.000 MHz	6	623.250 MHz
7	625.325 MHz	7	625.575 MHz	7	625.825 MHz	7	626.075 MHz	7	626.325 MHz
8	629.175 MHz	8	629.425 MHz	8	629.675 MHz	8	629.925 MHz	8	630.175 MHz
9	634.925 MHz	9	635.175 MHz	9	635.425 MHz	9	635.675 MHz	9	635.925 MHz
10	638.225 MHz	10	638.475 MHz	10	638.725 MHz	10	638.975 MHz	10	639.225 MHz
11	643.150 MHz	11	643.400 MHz	11	643.650 MHz	11	643.900 MHz	11	644.150 MHz
12	649.525 MHz	12	649.775 MHz	12	650.025 MHz	12	650.275 MHz	12	650.525 MHz
13	654.850 MHz	13	655.100 MHz	13	655.350 MHz	13	655.600 MHz	13	655.850 MHz
14	665.700 MHz	14	665.950 MHz	14	666.200 MHz	14	666.450 MHz	14	666.700 MHz

F		G		H		I		J	
CH	Frequency	CH	Frequency	CH	Frequency	CH	Frequency	CH	Frequency
1	611.250 MHz	1	611.500 MHz	1	611.750 MHz	1	612.000 MHz	1	612.250 MHz
2	613.275 MHz	2	613.525 MHz	2	613.775 MHz	2	614.025 MHz	2	614.275 MHz
3	615.500 MHz	3	615.750 MHz	3	616.000 MHz	3	616.250 MHz	3	616.500 MHz
4	617.950 MHz	4	618.200 MHz	4	618.450 MHz	4	618.700 MHz	4	618.950 MHz
5	620.625 MHz	5	620.875 MHz	5	621.125 MHz	5	621.375 MHz	5	621.625 MHz
6	623.500 MHz	6	623.750 MHz	6	624.000 MHz	6	624.250 MHz	6	624.500 MHz
7	626.575 MHz	7	626.825 MHz	7	627.075 MHz	7	627.325 MHz	7	627.575 MHz
8	630.425 MHz	8	630.675 MHz	8	630.925 MHz	8	631.175 MHz	8	631.425 MHz
9	636.175 MHz	9	636.425 MHz	9	636.675 MHz	9	636.925 MHz	9	637.175 MHz
10	639.475 MHz	10	639.725 MHz	10	639.975 MHz	10	640.225 MHz	10	640.475 MHz
11	644.400 MHz	11	644.650 MHz	11	644.900 MHz	11	645.150 MHz	11	645.400 MHz
12	650.775 MHz	12	651.025 MHz	12	651.275 MHz	12	651.525 MHz	12	651.775 MHz
13	656.100 MHz	13	656.350 MHz	13	656.600 MHz	13	656.850 MHz	13	657.100 MHz
14	666.950 MHz	14	667.200 MHz	14	667.450 MHz	14	667.700 MHz	14	667.950 MHz

## 6. Troubleshooting

This troubleshooting guide contains solutions to problems which can be carried out by an ordinary person. The device does not contain user-serviceable parts.

Unauthorized modifications to the device will render the warranty void. Such modifications may result in injuries and material damage.

Refer servicing to instructed or skilled persons. Contact your Highlite International dealer in case the solution is not described in the table.

Problem	Probable cause(s)	Solution
The devices do not function at all	No power to the devices	<ul style="list-style-type: none"> <li>• Make sure that the receiver is switched on and connected to power supply</li> <li>• Make sure that the batteries in the transmitter are inserted correctly</li> </ul>
	The batteries in the transmitter are depleted	<ul style="list-style-type: none"> <li>• Change the batteries. See <b>4.3.6. Installation of the Batteries</b> on page 19</li> </ul>
No sound	The transmitter is switched off or does not function correctly	<ul style="list-style-type: none"> <li>• Make sure that the transmitter is switched on and the batteries are not depleted</li> </ul>
	The transmitter is muted	<ul style="list-style-type: none"> <li>• Make sure the transmitter is not muted</li> </ul>
	The volume is too low	<ul style="list-style-type: none"> <li>• Turn up the volume on the receiver</li> <li>• Make sure that the volume on the connected devices is turned up</li> </ul>
	Channel selection	<ul style="list-style-type: none"> <li>• Make sure that the receiver and the transmitter are paired. See <b>4.3.8. Pairing</b> on page 20</li> </ul>
	The transmitter is out of range	<ul style="list-style-type: none"> <li>• Move the transmitter closer to the receiver</li> </ul>
	Connections are defective	<ul style="list-style-type: none"> <li>• Examine connections and cables. Correct defective connections. Repair or replace damaged cables</li> </ul>
	The connected mixer or amplifier does not function correctly	<ul style="list-style-type: none"> <li>• Make sure that the connected mixer or amplifier is switched on and functions correctly</li> </ul>
Bursts of noise or other audible signals present	Sources of interference are present	<ul style="list-style-type: none"> <li>• Adjust the squelch threshold. See <b>5.3.1.10. Squelch</b> on page 27</li> </ul>
		<ul style="list-style-type: none"> <li>• Change the channel frequency</li> </ul>
		<ul style="list-style-type: none"> <li>• Identify potential sources of interference (other RF-sources) and turn them off</li> </ul>

### 6.1. Adjusting the Microphone Gain

To adjust the microphone gain, see **5.4.2.4. Gain** on page 31.

## 7. Maintenance

---

### 7.1. Preventive Maintenance

**Attention**

Before use, examine the device visually for any defects.

Make sure that:

- All screws used for installing the device or parts of the device are tightly fastened and are not corroded.
- There are no deformations on housings, fixations and installation points.
- The power cables are not damaged and do not show any material fatigue.

#### 7.1.1. Basic Cleaning Instructions

To clean the device, follow the steps below:

- 01) Disconnect the device from the electrical power supply.
- 02) Allow the device to cool down for 5 minutes.
- 03) Clean the device with a soft, lint-free cloth.

**Attention**

- Do not immerse the device in liquid.
- Do not use alcohol or solvents.

### 7.2. Corrective Maintenance

The device does not contain user-serviceable parts. Do not open the device and do not modify the device.

Refer repairs and servicing to instructed or skilled persons. Contact your Highlite International dealer for more information.

## 8. Deinstallation, Transportation and Storage

---

- Disconnect power supply before deinstallation.
- Use the original packaging to transport the device, if possible.
- Clean the device before storing. Follow the cleaning instructions in chapter **7.1.1. Basic Cleaning Instructions** on page 35.
- Store the device in the original packaging, if possible.

## 9. Disposal

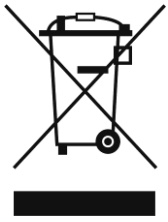

### Correct disposal of this product

Waste Electrical and Electronic Equipment

This symbol on the product, its packaging or documents indicates that the product shall not be treated as household waste. Dispose of this product by handing it to the respective collection point for recycling of electrical and electronic equipment. This is to avoid environmental damage or personal injury due to uncontrolled waste disposal. For more detailed information about recycling of this product contact the local authorities or the authorized dealer.

## 10. Approval



Hereby, Highlite International declares that the device EDGE EHS-2, product code D1479B, is in compliance with Directive 2014/53/EU (RED – Radio Equipment Directive).

The full text of the EU declaration of conformity is available at the respective product page on the website of Highlite International ([www.highlite.com](http://www.highlite.com)).

The DAP EDGE EHS-2 is a Class 2 wireless audio device (Commission Decision 2000/299/EC).

Frequency: 610–668 MHz

	BE	DK	DE	FR	HR	LV	LT	MT
	NL	AT	PL	RO	SK	ES	SE	

### Exclusion of liability

The frequency ranges available for radio transmitters differ per country and region. Consult the respective national and/or regional authority as licensing or specific restrictions may apply for the use of the device. We do not take any responsibility in case the device cannot operate or cannot be used in your country/region or if it requires additional licensing. Before using the device, check the allowed frequencies in your country or region.







©2023 DAP