

User Manual

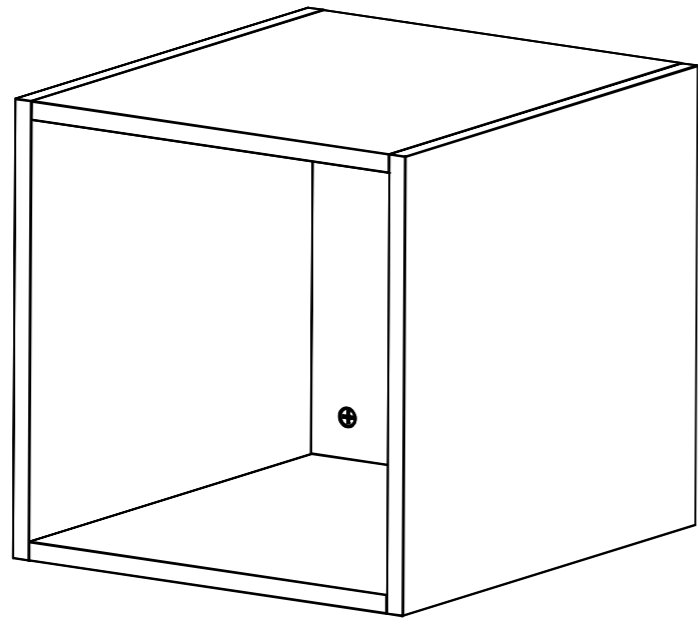

Open the box and find all these parts
Place them on a clean and soft floor
Assemble them carefully as per drawings
Tighten all the screws and bolts

2

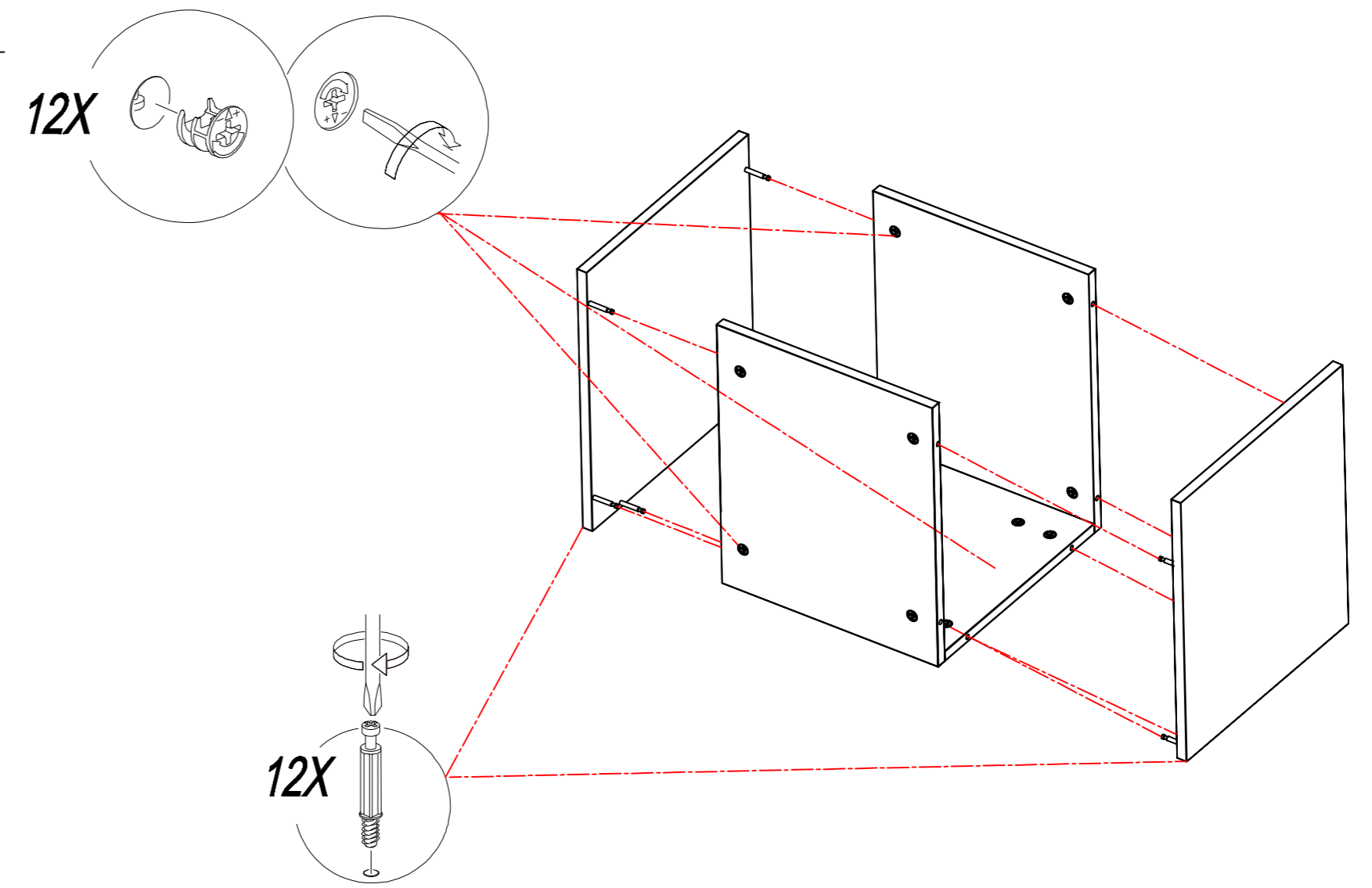

3

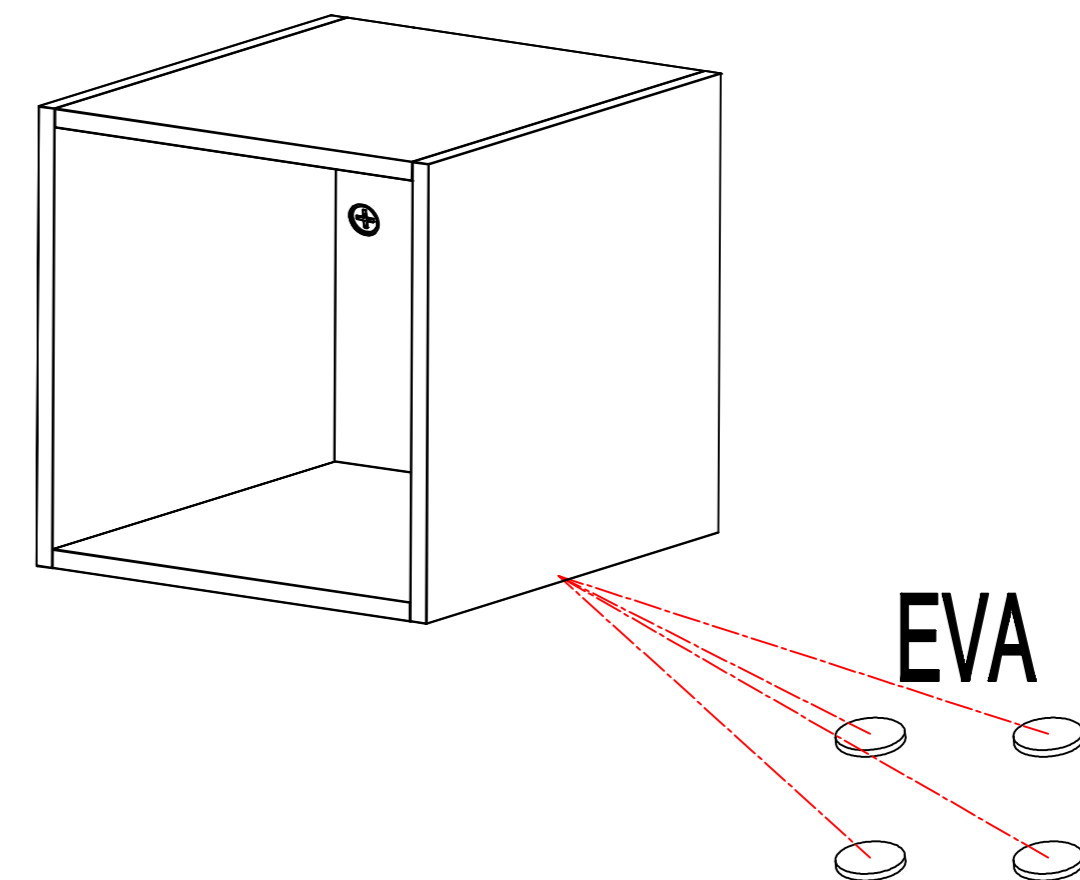

1

