

Genos

DIGITAL WORKSTATION

Owner's Manual

Before using the instrument, be sure to read "PRECAUTIONS" on page 5.

SPECIAL MESSAGE SECTION

PRODUCT SAFETY MARKINGS: Yamaha electronic products may have either labels similar to the graphics shown below or molded/stamped facsimiles of these graphics on the enclosure. The explanation of these graphics appears on this page. Please observe all cautions indicated on this page and those indicated in the safety instruction section.

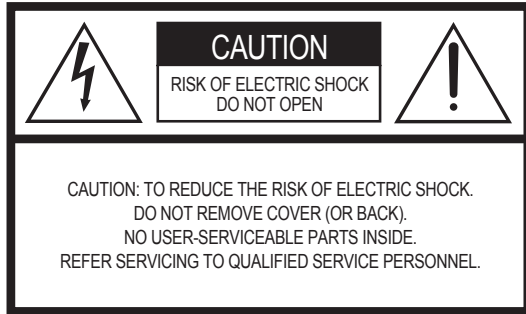

See bottom of Keyboard enclosure for graphic symbol markings.



The exclamation point within the equilateral triangle is intended to alert the user to the presence of important operating and maintenance (servicing) instructions in the literature accompanying the product.

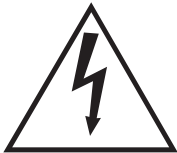

The lightning flash with arrowhead symbol, within the equilateral triangle, is intended to alert the user to the presence of uninsulated “dangerous voltage” within the product’s enclosure that may be of sufficient magnitude to constitute a risk of electrical shock.

IMPORTANT NOTICE: All Yamaha electronic products are tested and approved by an independent safety testing laboratory in order that you may be sure that when it is properly installed and used in its normal and customary manner, all foreseeable risks have been eliminated. **DO NOT** modify this unit or commission others to do so unless specifically authorized by Yamaha. Product performance and/or safety standards may be diminished. Claims filed under the expressed warranty may be denied if the unit is/has been modified. Implied warranties may also be affected.

SPECIFICATIONS SUBJECT TO CHANGE: The information contained in this manual is believed to be correct at the time of printing. However, Yamaha reserves the right to change or modify any of the specifications without notice or obligation to update existing units.

ENVIRONMENTAL ISSUES: Yamaha strives to produce products that are both user safe and environmentally friendly. We sincerely believe that our products and the production methods used to produce them, meet these goals. In keeping with both the letter and the spirit of the law, we want you to be aware of the following:

Battery Notice: This product MAY contain a small non-rechargeable battery which (if applicable) is soldered in place. The average life span of this type of battery is approximately five years. When replacement becomes necessary, contact a qualified service representative to perform the replacement.

Warning: Do not attempt to recharge, disassemble, or incinerate this type of battery. Keep all batteries away from children. Dispose of used batteries promptly and as regulated by applicable laws. Note: In some areas, the servicer is required by law to return the defective parts. However, you do have the option of having the servicer dispose of these parts for you.

Disposal Notice: Should this product become damaged beyond repair, or for some reason its useful life is considered to be at an end, please observe all local, state, and federal regulations that relate to the disposal of products that contain lead, batteries, plastics, etc.

NOTICE: Service charges incurred due to lack of knowledge relating to how a function or effect works (when the unit is operating as designed) are not covered by the manufacturer’s warranty, and are therefore the owners responsibility. Please study this manual carefully and consult your dealer before requesting service.

NAME PLATE LOCATION: The graphic below indicates the location of the name plate. The model number, serial number, power requirements, etc., are located on this plate. You should record the model number, serial number, and the date of purchase in the spaces provided below and retain this manual as a permanent record of your purchase.

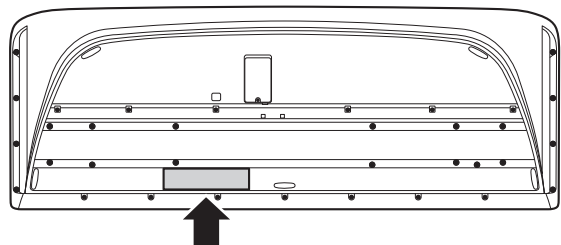

Model _____

Serial No. _____

Purchase Date _____

FCC INFORMATION (U.S.A.)

1. IMPORTANT NOTICE: DO NOT MODIFY THIS UNIT!

This product, when installed as indicated in the instructions contained in this manual, meets FCC requirements. Modifications not expressly approved by Yamaha may void your authority, granted by the FCC, to use the product.

2. IMPORTANT: When connecting this product to accessories and/or another product use only high quality shielded cables. Cable/s supplied with this product MUST be used. Follow all installation instructions. Failure to follow instructions could void your FCC authorization to use this product in the USA.

3. NOTE: This product has been tested and found to comply with the requirements listed in FCC Regulations, Part 15 for Class "B" digital devices. Compliance with these requirements provides a reasonable level of assurance that your use of this product in a residential environment will not result in harmful interference with other electronic devices. This equipment generates/uses radio frequencies and, if not installed and used according to the instructions found in the users manual, may cause interference harmful to the operation of other electronic devices. Compliance with FCC regulations does

not guarantee that interference will not occur in all installations. If this product is found to be the source of interference, which can be determined by turning the unit "OFF" and "ON", please try to eliminate the problem by using one of the following measures:

Relocate either this product or the device that is being affected by the interference.

Utilize power outlets that are on different branch (circuit breaker or fuse) circuits or install AC line filter/s.

In the case of radio or TV interference, relocate/reorient the antenna. If the antenna lead-in is 300 ohm ribbon lead, change the lead-in to co-axial type cable.

If these corrective measures do not produce satisfactory results, please contact the local retailer authorized to distribute this type of product. If you can not locate the appropriate retailer, please contact Yamaha Corporation of America, Electronic Service Division, 6600 Orangethorpe Ave, Buena Park, CA90620

The above statements apply ONLY to those products distributed by Yamaha Corporation of America or its subsidiaries.

* This applies only to products distributed by YAMAHA CORPORATION OF AMERICA.

(class B)

FCC and IC Information

For U.S.A.

This transmitter must not be co-located or operated in conjunction with any other antenna or transmitter.

For CANADA

This device complies with Industry Canada's applicable licence exempt RSSs. Operation is subject to the following two conditions:

- (1) This device may not cause interference; and
- (2) This device must accept any interference, including interference that may cause undesired operation of the device.

For U.S.A. and CANADA

FCC/IC RF Radiation Exposure Statement

This equipment complies with FCC/IC radiation exposure limits set forth for an uncontrolled environment and meets the FCC radio frequency (RF) Exposure Guidelines and RSS-102 of the IC radio frequency (RF) Exposure rules. This equipment should be installed and operated keeping the radiator at least 20cm or more away from person's body.

COMPLIANCE INFORMATION STATEMENT (DECLARATION OF CONFORMITY PROCEDURE)

Responsible Party : Yamaha Corporation of America

Address : 6600 Orangethorpe Ave., Buena Park, Calif.
90620

Telephone : 714-522-9011

Type of Equipment : DIGITAL KEYBOARD

Model Name : Genos

This device complies with Part 15 of the FCC Rules.

Operation is subject to the following two conditions:

- 1) this device may not cause harmful interference, and
- 2) this device must accept any interference received including interference that may cause undesired operation.

See user manual instructions if interference to radio reception is suspected.

* This applies only to products distributed by
YAMAHA CORPORATION OF AMERICA.

(FCC DoC)

Information for users on collection and disposal of old equipment:



This symbol on the products, packaging, and/or accompanying documents means that used electrical and electronic products should not be mixed with general household waste.

For proper treatment, recovery and recycling of old products, please take them to applicable collection points, in accordance with your national legislation.

By disposing of these products correctly, you will help to save valuable resources and prevent any potential negative effects on human health and the environment which could otherwise arise from inappropriate waste handling.

For more information about collection and recycling of old products, please contact your local municipality, your waste disposal service or the point of sale where you purchased the items.

For business users in the European Union:

If you wish to discard electrical and electronic equipment, please contact your dealer or supplier for further information.

Information on Disposal in other Countries outside the European Union:

This symbol is only valid in the European Union. If you wish to discard these items, please contact your local authorities or dealer and ask for the correct method of disposal.

(weee_en_en_02)

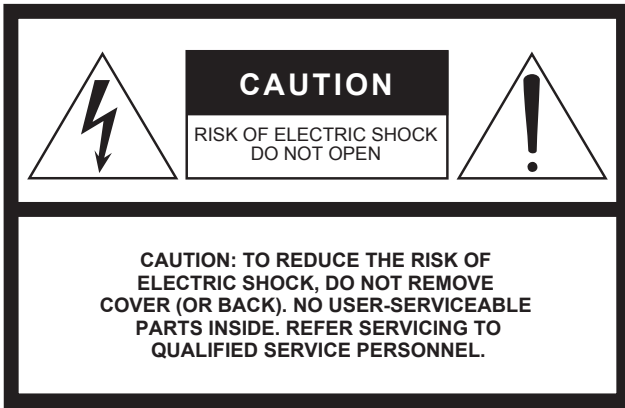

Explanation of Graphical Symbols

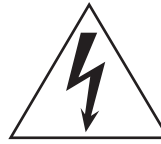

The lightning flash with arrowhead symbol within an equilateral triangle is intended to alert the user to the presence of uninsulated “dangerous voltage” within the product’s enclosure that may be of sufficient magnitude to constitute a risk of electric shock to persons.



The exclamation point within an equilateral triangle is intended to alert the user to the presence of important operating and maintenance (servicing) instructions in the literature accompanying the product.

The above warning is located on the bottom of the unit.

IMPORTANT SAFETY INSTRUCTIONS

- 1 Read these instructions.
- 2 Keep these instructions.
- 3 Heed all warnings.
- 4 Follow all instructions.
- 5 Do not use this apparatus near water.
- 6 Clean only with dry cloth.
- 7 Do not block any ventilation openings. Install in accordance with the manufacturer’s instructions.
- 8 Do not install near any heat sources such as radiators, heat registers, stoves, or other apparatus (including amplifiers) that produce heat.
- 9 Do not defeat the safety purpose of the polarized or grounding-type plug. A polarized plug has two blades with one wider than the other. A grounding type plug has two blades and a third grounding prong. The wide blade or the third prong are provided for your safety. If the provided plug does not fit into your outlet, consult an electrician for replacement of the obsolete outlet.
- 10 Protect the power cord from being walked on or pinched particularly at plugs, convenience receptacles, and the point where they exit from the apparatus.

- 11 Only use attachments/accessories specified by the manufacturer.
- 12 Use only with the cart, stand, tripod, bracket, or table specified by the manufacturer, or sold with the apparatus. When a cart is used, use caution when moving the cart/apparatus combination to avoid injury from tip-over.
- 13 Unplug this apparatus during lightning storms or when unused for long periods of time.
- 14 Refer all servicing to qualified service personnel. Servicing is required when the apparatus has been damaged in any way, such as power-supply cord or plug is damaged, liquid has been spilled or objects have fallen into the apparatus, the apparatus has been exposed to rain or moisture, does not operate normally, or has been dropped.



WARNING

TO REDUCE THE RISK OF FIRE OR ELECTRIC SHOCK, DO NOT EXPOSE THIS APPARATUS TO RAIN OR MOISTURE.

(UL60065_03)

The model number, serial number, power requirements, etc., may be found on or near the name plate, which is at the bottom of the unit. You should note this serial number in the space provided below and retain this manual as a permanent record of your purchase to aid identification in the event of theft.

Model No.

Serial No.

(bottom_en_01)

OBSERVERA!

Apparaten kopplas inte ur växelströmskällan (nätet) så länge som den är ansluten till vägguttaget, även om själva apparaten har stängts av.

ADVARSSEL: Netspændingen til dette apparat er IKKE afbrudt, så længe netledningen sidder i en stikkontakt, som er tændt — også selvom der er slukket på apparatets afbryder.

VAROITUS: Laitteen toisiopiiriin kytketty käyttökytkin ei irroita koko laitetta verkosta.

(standby)

PRECAUTIONS

PLEASE READ CAREFULLY BEFORE PROCEEDING

Please keep this manual in a safe and handy place for future reference.



WARNING

Always follow the basic precautions listed below to avoid the possibility of serious injury or even death from electrical shock, short-circuiting, damages, fire or other hazards. These precautions include, but are not limited to, the following:

Power supply/Power cord

- Do not place the power cord near heat sources such as heaters or radiators. Also, do not excessively bend or otherwise damage the cord, or place heavy objects on it.
- Only use the voltage specified as correct for the instrument. The required voltage is printed on the name plate of the instrument.
- Use only the supplied power cord/plug.
- Check the electric plug periodically and remove any dirt or dust which may have accumulated on it.
- Be sure to connect to an appropriate outlet with a protective grounding connection. Improper grounding can result in electrical shock.

Do not open

- This instrument contains no user-serviceable parts. Do not attempt to disassemble or modify the internal components in any way. If it should appear to be malfunctioning, discontinue use immediately and have it inspected by qualified Yamaha service personnel.

Location

- Radio waves may affect electro-medical devices.
 - Do not use this product near medical devices or inside areas in which the use of radio waves is restricted.
 - Do not use this product within 15cm (6 in.) of persons with a heart pacemaker implant.

Water warning

- Do not expose the instrument to rain, use it near water or in damp or wet conditions, or place on it any containers (such as vases, bottles or glasses) containing liquids which might spill into any openings. If any liquid such as water seeps into the instrument, turn off the power immediately and unplug the power cord from the AC outlet. Then have the instrument inspected by qualified Yamaha service personnel.
- Never insert or remove an electric plug with wet hands.

Fire warning

- Do not put burning items, such as candles, on the unit. A burning item may fall over and cause a fire.

If you notice any abnormality

- When one of the following problems occur, immediately turn off the power switch and disconnect the electric plug from the outlet. Then have the device inspected by Yamaha service personnel.
 - The power cord or plug becomes frayed or damaged.
 - It emits unusual smells or smoke.
 - Some object has been dropped into the instrument.
 - There is a sudden loss of sound during use of the instrument.



CAUTION

Always follow the basic precautions listed below to avoid the possibility of physical injury to you or others, or damage to the instrument or other property. These precautions include, but are not limited to, the following:

Power supply/Power cord

- Do not connect the instrument to an electrical outlet using a multiple-connector. Doing so can result in lower sound quality, or possibly cause overheating in the outlet.
- When removing the electric plug from the instrument or an outlet, always hold the plug itself and not the cord. Pulling by the cord can damage it.
- Remove the electric plug from the outlet when the instrument is not to be used for extended periods of time, or during electrical storms.

Location

- Do not place the instrument in an unstable position where it might accidentally fall over.
- Before moving the instrument, remove all connected cables, to prevent damage to the cables or injury to anyone who might trip over them.
- When setting up the product, make sure that the AC outlet you are using is easily accessible. If some trouble or malfunction occurs, immediately turn off the power switch and disconnect the plug from the outlet. Even when the power switch is turned off, electricity is still flowing to the product at the minimum level. When you are not using the product for a long time, make sure to unplug the power cord from the wall AC outlet.
- Use only the stand specified for the instrument. When attaching it, use the provided screws only. Failure to do so could cause damage to the internal components or result in the instrument falling over.

Connections

- Before connecting the instrument to other electronic components, turn off the power for all components. Before turning the power on or off for all components, set all volume levels to minimum.
- Be sure to set the volumes of all components at their minimum levels and gradually raise the volume controls while playing the instrument to set the desired listening level.

Handling caution

- Do not insert a finger or hand in any gaps on the instrument.
- Never insert or drop paper, metallic, or other objects into the gaps on the panel. This could cause physical injury to you or others, damage to the instrument or other property, or operational failure.
- Do not rest your weight on, or place heavy objects on the instrument, and do not use excessive force on the buttons, switches or connectors.
- Do not use the instrument/device or headphones for a long period of time at a high or uncomfortable volume level, since this can cause permanent hearing loss. If you experience any hearing loss or ringing in the ears, consult a physician.

Yamaha cannot be held responsible for damage caused by improper use or modifications to the instrument, or data that is lost or destroyed.

Always turn the power off when the instrument is not in use.

Even when the [⏻] (Standby/On) switch is in standby status (display is off), electricity is still flowing to the instrument at the minimum level.

When you are not using the instrument for a long time, make sure you unplug the power cord from the wall AC outlet.

Notices and Information

NOTICE

To avoid the possibility of malfunction/ damage to the product, damage to data, or damage to other property, follow the notices below.

■ Handling

- Do not use the instrument in the vicinity of a TV, radio, stereo equipment, mobile phone, or other electric devices. Otherwise, the instrument, TV, or radio may generate noise. When you use the instrument along with an application on your iPad, iPhone or iPod touch, we recommend that you set "Airplane Mode" to "ON" on that device in order to avoid noise caused by communication.
- Do not expose the instrument to excessive dust or vibrations, or extreme cold or heat (such as in direct sunlight, near a heater, or in a car during the day) to prevent the possibility of panel disfiguration, damage to the internal components or unstable operation. (Verified operating temperature range: 5° – 40°C, or 41° – 104°F.)
- Do not place vinyl, plastic or rubber objects on the instrument, since this might discolor the panel or keyboard.

■ Maintenance

- When cleaning the instrument, use a soft cloth. Do not use paint thinners, solvents, alcohol, cleaning fluids, or chemical-impregnated wiping cloths.

■ Saving data

- Edited Song/Style/Voice/MIDI setup data, etc. are lost when you turn off the power to the instrument without saving. This also occurs when the power is turned off by the Auto Power Off function (page 24). Save the data to the instrument, or to USB flash drive/an external device such as a computer (page 37). Saving the data to USB flash drive/an external device is even more secure, since the data in the instrument may be lost due to some failure, an operation mistake, etc. Before using a USB flash drive, make sure to refer to page 111.
- To protect against data loss through USB flash drive damage, we recommend that you save your important data onto spare USB flash drive or an external device such as a computer as backup data.
- System Setup data (data other than the edited Song/Style/Voice/MIDI setup data, etc.) is automatically stored, when you change the settings in a display page and then exit from that page. However, the data is lost if you turn off the power without properly exiting from the relevant display. For information about the System Setup data, refer to the Parameter Chart of the Data List on the website.
- If the power switch is not turned on for longer than about a week, the time (clock) setting may be lost.

Information

■ About copyrights

- Copying of the commercially available musical data including but not limited to MIDI data and/or audio data is strictly prohibited except for your personal use.
- This product incorporates and bundles contents in which Yamaha owns copyrights or with respect to which Yamaha has license to use others' copyrights. Due to copyright laws and other relevant laws, you are NOT allowed to distribute media in which these contents are saved or recorded and remain virtually the same or very similar to those in the product.
 - * The contents described above include computer applications, Accompaniment Style data, MIDI data, WAVE data, voice recording data, a score, score data, etc.
 - * You are allowed to distribute media in which your performance or music production using these contents is recorded, and the permission of Yamaha Corporation is not required in such cases.

■ About functions/data bundled with the instrument

- Some of the preset songs have been edited for length or arrangement, and may not be exactly the same as the original.
- This device is capable of using various types/formats of music data by optimizing them to the proper format music data for use with the device in advance. As a result, this device may not play them back precisely as their producers or composers originally intended.
- The bitmap fonts used in this instrument have been provided by and are the property of Ricoh Co., Ltd.

Yamaha may from time to time update firmware of the product without notice for improvement in functions and usability. To take full advantage of this instrument, we recommend that you upgrade your instrument to the latest version. The latest firmware can be downloaded from the website below:

<http://download.yamaha.com/>

Copyright Notice

The followings are the titles, credits and copyright notices for the songs pre-installed in this instrument.

Eye Of The Tiger

Theme from ROCKY III
Words and Music by Frank Sullivan and Jim Peterik
Copyright (c) 1982 Sony/ATV Music Publishing LLC, Rude Music, Three Wise Boys LLC, WB Music Corp. and Easy Action Music
All Rights on behalf of Sony/ATV Music Publishing LLC, Rude Music and Three Wise Boys LLC Administered by Sony/ATV Music Publishing LLC, 424 Church Street, Suite 1200, Nashville, TN 37219
All Rights on behalf of Easy Action Music Administered by WB Music Corp.
International Copyright Secured All Rights Reserved

Game Of Thrones

Theme from the HBO Series GAME OF THRONES
By Ramin Djawadi
Copyright (c) 2011 TL MUSIC PUBLISHING
All Rights Administered by UNIVERSAL MUSIC CORP.
All Rights Reserved Used by Permission

The Girl From Ipanema (Garôta De Ipanema)

Music by Antonio Carlos Jobim
English Words by Norman Gimbel
Original Words by Vinicius de Moraes
Copyright (c) 1963 ANTONIO CARLOS JOBIM and VINICIUS DE MORAES, Brazil
Copyright Renewed 1991 and Assigned to SONGS OF UNIVERSAL, INC. and WORDS WEST LLC
English Words Renewed 1991 by NORMAN GIMBEL for the World and Assigned to WORDS WEST LLC (P.O. Box 15187, Beverly Hills, CA 90209 USA)
All Rights Reserved Used by Permission

Living Next Door To Alice

Words and Music by Nicky Chinn and Mike Chapman
Copyright (c) 1977 by Universal Music - MGB Songs
Copyright Renewed
International Copyright Secured All Rights Reserved

Love Really Hurts Without You

Words and Music by Ben Findon and Les Charles
(c) 1984 EMI MUSIC PUBLISHING LTD.
All Rights in the U.S. and Canada Controlled and Administered by EMI LONGITUDE MUSIC
All Rights Reserved International Copyright Secured Used by Permission

Moon River

from the Paramount Picture BREAKFAST AT TIFFANY'S
Words by Johnny Mercer
Music by Henry Mancini
Copyright (c) 1961 Sony/ATV Music Publishing LLC
Copyright Renewed
All Rights Administered by Sony/ATV Music Publishing LLC, 424 Church Street, Suite 1200, Nashville, TN 37219
International Copyright Secured All Rights Reserved

More Than Words

Words and Music by Nuno Bettencourt and Gary Cherone
Copyright (c) 1990 COLOR ME BLIND MUSIC
All Rights Administered by ALMO MUSIC CORP.
All Rights Reserved Used by Permission

A Sky Full Of Stars

Words and Music by Guy Berryman, Jon Buckland, Will Champion, Chris Martin and Tim Bergling
Copyright (c) 2014 by Universal Music Publishing MGB Ltd. and EMI Blackwood Music Inc.
All Rights for Universal Music Publishing MGB Ltd. in the United States and Canada
Administered by Universal Music - MGB Songs
All Rights for EMI Blackwood Music Inc. Administered by Sony/ATV Music Publishing LLC, 424 Church Street, Suite 1200, Nashville, TN 37219
International Copyright Secured All Rights Reserved

Wake Me Up!

Words and Music by Aloe Blacc, Tim Bergling and Michael Einziger
(c) 2013 WB MUSIC CORP., ALOE BLACC PUBLISHING, EMI MUSIC PUBLISHING SCANDINAVIA AB, UNIVERSAL MUSIC CORP. and ELEMENTARY PARTICLE MUSIC
All Rights on behalf of itself and ALOE BLACC PUBLISHING Administered by WB MUSIC CORP.
All Rights on behalf of EMI MUSIC PUBLISHING SCANDINAVIA AB Administered by SONY/ATV MUSIC PUBLISHING LLC, 424 Church Street, Suite 1200, Nashville, TN 37219
All Rights on behalf of ELEMENTARY PARTICLE MUSIC Controlled and Administered by UNIVERSAL MUSIC CORP.
All Rights Reserved Used by Permission

Hulapalu

Words and Music by Andreas GABALIER
© 2015 by Edition Stall c/o Melodie der Welt GmbH & Co.KG, 60313 Frankfurt am Main

Congratulations!

You are the proud owner of an extraordinary electronic keyboard.

In addition to its stylish curved design, the Yamaha Genos combines the most advanced tone generation technology with state-of-the-art digital electronics to give you stunning sound with maximum musical versatility—a beautiful instrument from every perspective.

In order to make the most of your Genos's features and vast performance potential, we urge you to read the manual thoroughly while trying out the various features described. Keep the manual in a safe place for later reference.

Included Accessories

- Owner's Manual (this book)
- Online Member Product Registration
- AC Power Cord
- Music Rest, two Music Rest Brackets

About the Manuals

This instrument has the following documents and instructional materials.

Included Documents



Owner's Manual (this book)

Provides overall explanations of Genos basic functions.

Online Materials (Downloadable from the web)



Reference Manual (only in English, French, German, Italian, Dutch, and Polish)

Explains advanced features of the instrument, such as creating original Styles, Songs and Multi Pads, and making the settings of specific parameters.



Data List

Contains various important preset content lists such as Voices, Styles, Effects, as well as MIDI-related information.



iPhone/iPad Connection Manual (page 112)

Explains how to connect the instrument to smart devices, such as an iPhone, iPad, etc.



Computer-related Operations (page 113)

Includes instructions on connecting the instrument to a computer, and operations related to transferring song data.

To obtain these materials, access the Yamaha Downloads, enter “Genos” to the Model Name box, then click [Search].

Yamaha Downloads

<http://download.yamaha.com/>

- The illustrations and LCD screens as shown in this manual are for instructional purposes only, and may appear somewhat different from those on your instrument.
- Windows is a registered trademark of Microsoft® Corporation in the United States and other countries.
- iPhone, iPad, and iPod touch are trademarks of Apple Inc., registered in the U.S. and other countries.
- The company names and product names in this manual are the trademarks or registered trademarks of their respective companies.

Main Features

Replacing the hugely successful Tyros, Genos is the new benchmark in Digital Workstation sound, design and user experience. Whether you're a professional musician or a hobbyist, Genos will inspire and intensify your musical performance and enjoyment.

● Extraordinarily expressive and realistic Voices

The sonic quality of every Voice in Genos is beyond any other Digital Workstation you've ever played—this instrument is quite simply a game changer. Everything you hear, whether it be the beautiful CFX piano, the lush strings or the punchy new Revo Drums, it just blows you away!

● Powerful DSP effect processing for enhancing the sound

From Reverb to Distortion, Rotary Speaker to Compressor, Genos boasts unprecedented DSP power.

Using the same VCM technology as Yamaha's professional high-end mixing consoles, Genos has the tools to create a perfect sound. Not only do the effects sound great, they look great, too—with stunning graphical user interfaces.

● Accompaniment Styles

Whatever genre of music you wish to perform, Genos is ready to accompany you with world-class arrangements, punchy drums and up to four times the DSP power of previous Digital Workstations. Never has there been a more perfect personal backing band.

● Versatile real-time controller—LIVE CONTROL

Instantly shape your sound with the all new LIVE CONTROL surface. A wide variety of functions can be assigned to the LIVE CONTROL knobs and sliders with the LIVE CONTROL view providing instant visual confirmation of your adjustments without interrupting the main display.

● Voice and Style expandability with the Yamaha Expansion Manager

With Yamaha Expansion Manager software on your computer you can continually expand the onboard content of your Genos by creating and installing your own custom or purchased Packs. Supporting WAV, AIFF and even SoundFont and REX formats, the scope of possibilities for new sounds and styles is virtually unlimited.

● Quick and easy set up with Playlist and Registration

Playlist is the new way to quickly setup Genos, no matter how large your repertoire is.

Organize your Registration Memories into convenient Playlists for instant recall during performance.

● Audio Function

Cross fade between two audio files with the new Dual Player or assign your own audio data on the Multi Pad, the creative potentials are huge. You can even record your performance directly to a high quality audio file ready to easily share.

Compatible formats for the instrument



GM (General MIDI) is one of the most common Voice allocation formats. GM System Level 2 is a standard specification that enhances the original GM format and improves Song data compatibility. It provides for increased polyphony, greater Voice selection, expanded Voice parameters, and integrated effect processing.



XG is a major enhancement of the GM System Level 1 format, and was developed by Yamaha specifically to provide more Voices and variations, as well as greater expressive control over Voices and effects, and to ensure compatibility of data well into the future.



GS was developed by the Roland Corporation. In the same way as Yamaha XG, GS is a major enhancement of the GM specifically to provide more Voices and Drum kits and their variations, as well as greater expressive control over Voices and effects.



The Yamaha XF format enhances the SMF (Standard MIDI File) standard with greater functionality and open-ended expandability for the future. The Genos is capable of displaying lyrics when an XF file containing lyric data is played.



SFF (Style File Format) is an original Style file format by Yamaha which uses a unique conversion system to provide high-quality automatic accompaniment based on a wide range of chord types. SFF GE (Guitar Edition) is an enhanced format of SFF, which features improved note transposition for guitar tracks.



AEM (Articulation Element Modeling) is the trademark of Yamaha's leading-edge tone generation technology. For information on AEM, refer to the Reference Manual on the website.

Contents

| | |
|--|-----------|
| PRECAUTIONS | 5 |
| Included Accessories | 9 |
| About the Manuals | 10 |
| Main Features | 11 |
| Using Genos—A Broad Overview | 14 |
| Main Functions | 16 |
| Panel Controls and Terminals | 18 |
| Starting Up | 22 |
| Audio Connections | 22 |
| Power Supply | 23 |
| Turning the Power On/Off | 23 |
| Making Basic Settings | 24 |
| Changing the Brightness of Lighting Buttons | 25 |
| Display Structure | 26 |
| LIVE CONTROL View (Sub Display) Structure | 27 |
| Main Display Structure—Using the Gateway Buttons | 28 |
| Basic Operations | 30 |
| Display Configuration | 30 |
| Closing the Current Display | 33 |
| Display-based Controls | 34 |
| Calling up the Desired Display Instantly—Direct Access | 36 |
| Playing the Demos | 36 |
| File Management | 37 |
| Entering Characters | 40 |
| Locking the Panel Settings (Panel Lock) | 41 |
| Using the Metronome | 41 |
| Quick Guide—For Performing on Genos | 42 |
| Operation Guide | |
| 1 Playing with Styles—Setups | 44 |
| Setting up Styles | 44 |
| Optimum Panel Settings for the Current Style (One Touch Setting) | 47 |
| Setting up Keyboard Parts | 48 |
| Selecting a Voice for Each Keyboard Part | 52 |
| Creating Original Organ Flutes Voices | 53 |
| Using Ensemble Voices | 54 |
| Setting up Keyboard Harmony/Arpeggio | 56 |
| Setting up Multi Pads | 59 |
| Memorizing Original Panel Settings to One Touch Setting | 60 |
| Changing the Pitch of the Keyboard | 61 |
| Setting up Assignable Controllers | 62 |
| Operation Guide | |
| 2 Playing with Styles—Operations While Performing | 64 |
| Operating Style Playback | 64 |
| Expressively Controlling Your Performance | 66 |
| Playing and Controlling Super Articulation Voices | 67 |
| Controlling Multi Pad Playback | 70 |

Operation Guide

3 Singing with Song Playback—Setting Up 72

Setting Up Song Playback 72
 Applying Effects to the Microphone Sound (Vocal Harmony) 76

Operation Guide

4 Singing with Song Playback—Operations While Performing 78

Controlling Song Playback 78
 Using Song Position Markers (MIDI Song only) 81
 Displaying Score, Lyrics, and Text files during Playback 83
 Adjusting the Volume Balance between SONG A and SONG B (Cross Fader) 85
 Controlling the Microphone Functions 85

Operation Guide

5 Adjusting the Parameters of Each Part—Mixer 86

Basic Procedure for the Mixer 86
 Turning Each Channel of the Style or MIDI Song On/Off 88
 Changing the Voice for Each Channel of the Style or MIDI Song 89

Operation Guide

6 Song Recording 90

MIDI Quick Recording 90
 Audio Quick Recording 91

Operation Guide

7 Storing and Calling up Custom Panel Setups—Registration Memory, Playlist 92

Saving and Recalling Custom Panel Setups with Registration Memory 93
 Managing a Large Repertoire by Using the Playlist 96

Operation Guide

8 Customizing for Optimum Performance 100

Customizing the Shortcuts on the Home Display 100
 Setting the Functions or Shortcuts to the ASSIGNABLE Buttons 100
 Making Global Settings (Utility) 101
 Adjusting the Sound at the Final Output (Master Compressor, Master EQ) 102
 Adding New Contents—Expansion Packs 103

Operation Guide

9 System Settings 104

Confirming the Firmware Version and Hardware ID 104
 Restoring the Factory-programmed Settings 104
 Data Backup and Restore 105

Connections—Using Your Instrument with Other Devices 106

Connecting a Microphone ([MIC INPUT] jack) 106
 Connecting the Optional Yamaha GNS-MS01 Speaker 108
 Connecting Audio Devices (LINE OUT jacks, AUX IN jacks, [DIGITAL OUT] jack) 108
 Connecting Footswitches/Foot Controllers (ASSIGNABLE FOOT PEDAL jacks) 110
 Connecting USB Devices ([USB TO DEVICE] terminal) 111
 Connecting to an iPhone/iPad (Wireless LAN function, [USB TO HOST], or MIDI terminals) 112
 Connecting to a Computer ([USB TO HOST] terminal) 113
 Connecting External MIDI Devices (MIDI terminals) 113

Function List 114

Appendix 116

Installing the Optional Speakers 116
 Direct Access Chart 118
 Troubleshooting 120
 Specifications 123
 Index 125

Using Genos—A Broad Overview

This section provides a helpful overview of the wide range of functions available in Genos, and places you can find necessary information on those topics. If you need help in understanding a feature, function or operation—or need to have a general understanding of what Genos can do and how to effectively use it—look through this section.

OM : Genos Owner’s Manual (this book). The relevant chapter names are shown after this symbol. For detailed information on each chapter, see “Contents” (page 12).

* : This material can be obtained from the Yamaha Downloads website (page 10).

Using Genos by itself

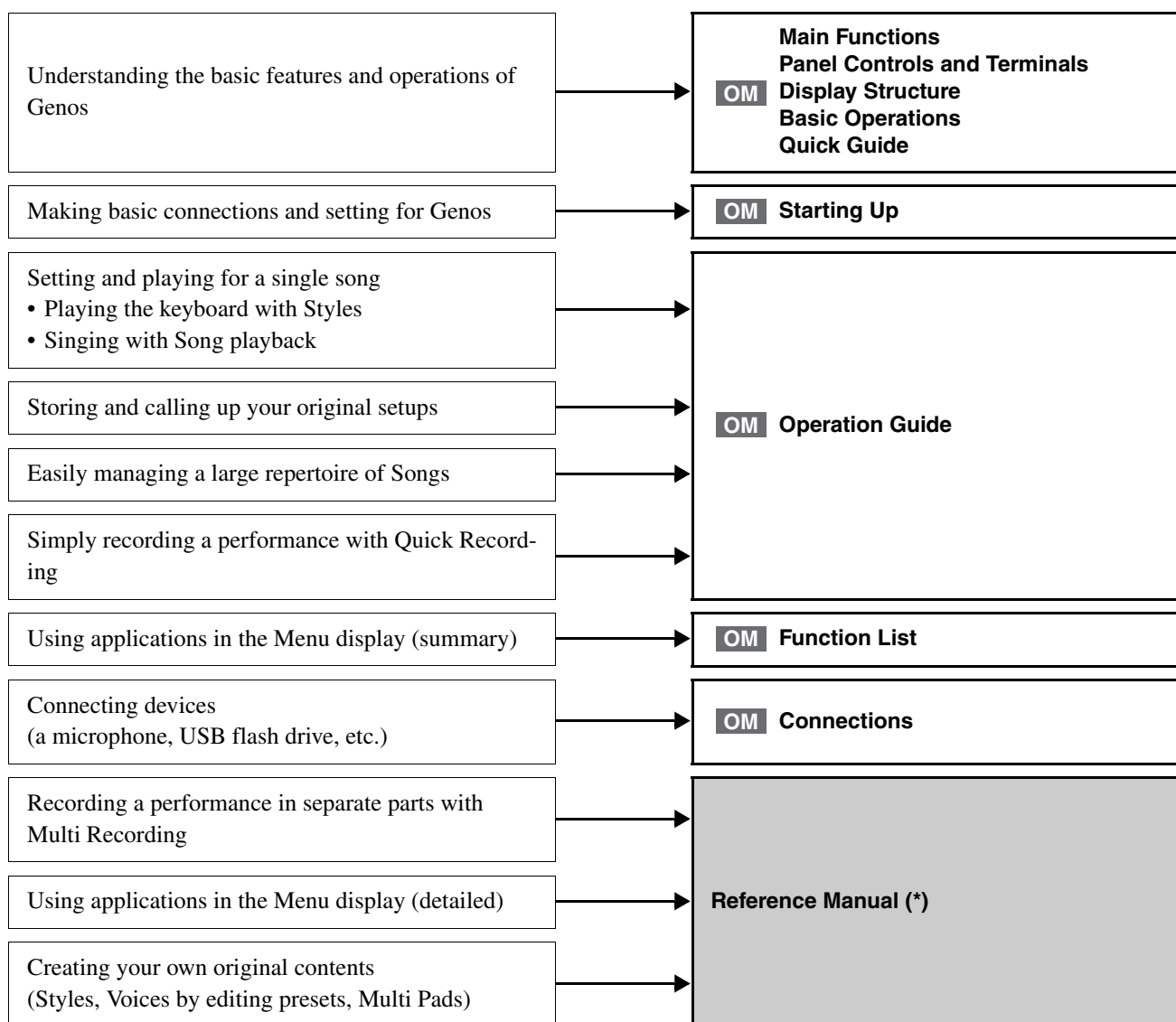

Using Genos with a computer

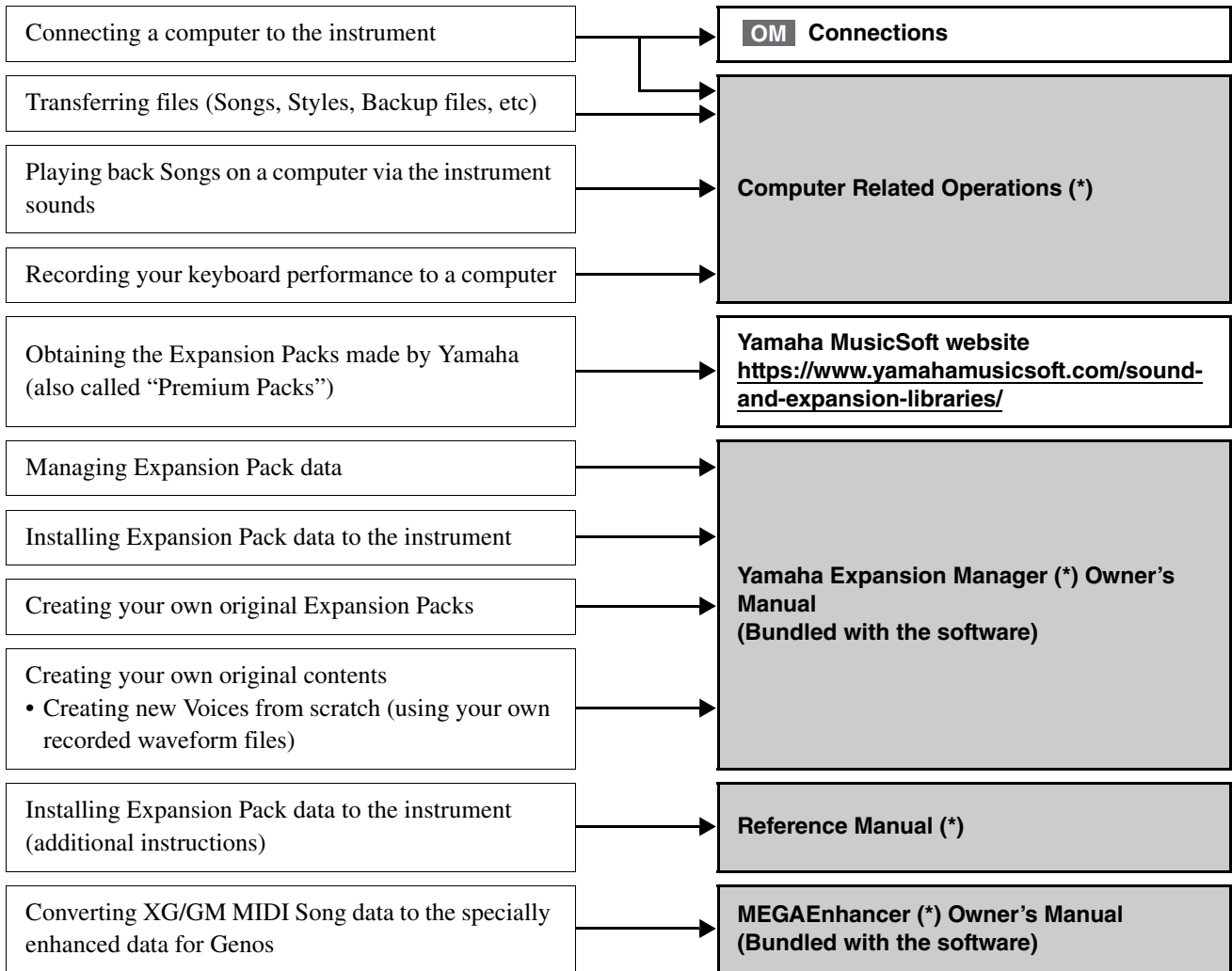
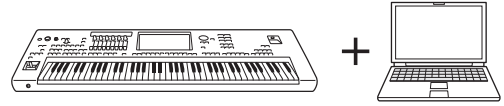

Using Genos with an iPhone/iPad

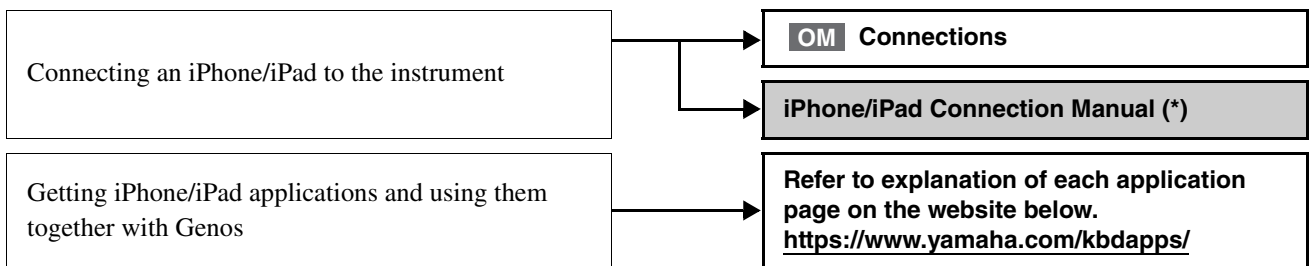
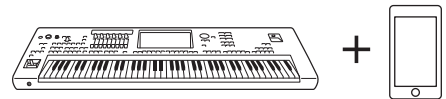

Main Functions

This section briefly explains the main functions of Genos, to help you better understand the overall capabilities of the instrument.

Styles—Rhythm and Auto Accompaniment—

Genos features a variety of accompaniment and rhythmic backing patterns (called “Styles”) in a variety of different musical genres including pop, jazz, and many others. Styles feature sophisticated Auto Accompaniment patterns, letting you produce automatic accompaniment playback simply by playing chords with your left hand. This lets you automatically recreate the sound of a full band or orchestra—even if you’re playing by yourself.

Voices—The individual sounds of Genos—

Genos features a wide variety of exceptionally realistic instrumental Voices, including piano, guitar, strings, brass, wind instruments and more. The Voices can be played manually on the keyboard, and they are also used by the Styles, MIDI Songs, and Multi Pads.

Keyboard Parts

There are four keyboard parts for your manual performance: LEFT, RIGHT 1, 2 and 3. Each part has one Voice. You can combine these parts by using the PART ON/OFF buttons to create luscious instrument textures and convenient performance combinations. You can change the keyboard range of the Parts by changing the Split Point.

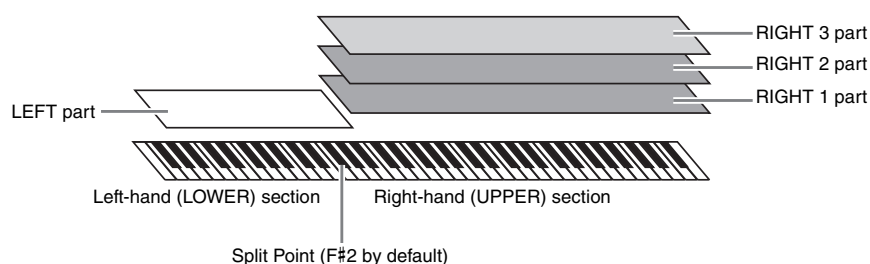

Multi Pads—Adding musical phrases to your performance—

The Multi Pads can be used to play a number of short pre-recorded rhythmic and melodic sequences that can be used to add impact and variety to your keyboard performances. Multi Pads are grouped in Banks of four phrases each. Genos features a variety of Multi Pad Banks in a variety of different musical genres. Moreover, the Audio Link Multi Pad function allows you to create unique, new pad content with your own audio (WAV) data for playing back during your performance.

Songs—Playing back MIDI/audio files—

For Genos, the term “Song” refers to MIDI or audio data, such as preset songs, commercially available files, etc. Not only can you play back a Song and listen to it, but you can also play the keyboard along with Song playback.

Song playback features two modes: Dual Player mode and Song List mode.

- **Dual Player:** Plays back two Audio Songs (or one Audio Song and one MIDI Song) simultaneously and makes a smooth transition between the two.
- **Song List:** Plays back Songs continuously according to a previously created Song List.

Mic Effects—Adding harmony vocals and synth vocoder effects to your singing—

By connecting a microphone to the MIC [INPUT] jack (either XLR or standard 1/4” phone plug connectors), you can enjoy singing along with your keyboard performance or with Song playback. The instrument outputs your vocals through the connected speaker system.

Moreover, you can automatically apply various Vocal Harmony effects to your voice as you sing, or you can use the Synth Vocoder feature to graft the unique characteristics of your voice onto synthesizer and other sounds.

Registration Memory—Saving and recalling custom panel setups—

The Registration Memory function allows you to save (or “register”) virtually all panel settings to a Registration Memory button, and then instantly recall your custom panel settings by simply pressing a single button. The registered settings for ten Registration Memory buttons are saved as a single Registration Bank (file).

Playlist—Managing large amounts of songs and settings—

The Playlist function makes it easy to manage and call up your songs and the related settings, no matter how numerous. The Playlist allows you to recall a specific song from more than 10 songs by a simple, single step. Up to 2500 songs can be registered in the Playlist, and you can call up the panel settings corresponding to each song by one tap.

Recording—Recording your performances—

Genos allows you to record your performance and save it as a MIDI file in SMF format. Genos also lets you record your performances as audio data (WAV) to internal User drive. In addition, each way of recording also features two convenient recording methods, Quick Recording and Multi Recording.

Panel Controls and Terminals

■ Top Panel

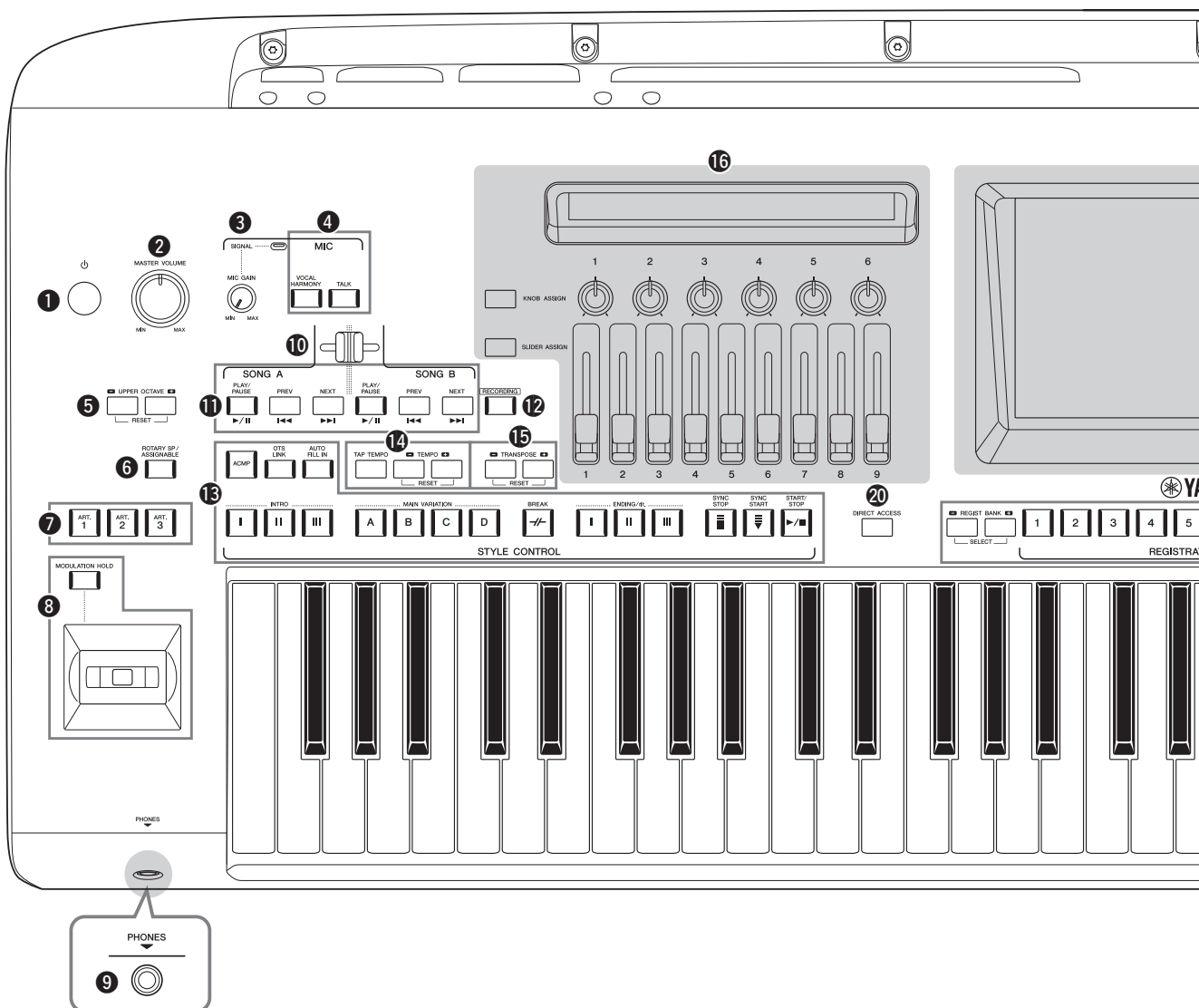

- 1** [⏻] (Standby/On) switch.....Page 23
Turns on the instrument's power or sets to standby.
- 2** [MASTER VOLUME] dialPage 23
Adjusts the overall volume.
- 3** [MIC GAIN] knob.....Page 106
Adjusts the input sensitivity from the MIC INPUT jack.
- 4** MIC buttons.....Page 85
For adding various effects to and controlling the Microphone input.
- 5** UPPER OCTAVE buttonsPage 61
Shifts the pitch of the keyboard in octave steps.
- 6** [ROTARY SP /ASSIGNABLE] button.....Page 63
Controls the rotary speaker effect or the assigned function.
- 7** [ART. 1]/[ART. 2]/[ART. 3] buttons.....Page 68
Controls Super Articulation Voices.
- 8** Joystick, [MODULATION HOLD] button....Page 66
For using pitch bend or modulation functions.
- 9** [PHONES] jackPage 22
For connecting a pair of headphones.
- 10** Cross FaderPage 85
Adjusts the volume balance between the Songs of SONG A and SONG B sides.
- 11** SONG A/SONG B buttonsPage 78
For selecting Songs and controlling Song playback.
- 12** [RECORDING] buttonPages 29, 90
For calling up the Song Recording display.
- 13** STYLE CONTROL buttonsPages 44, 64
For controlling Style playback.
- 14** [TAP TEMPO]/TEMPO buttons.....Page 46
For controlling the tempo for Style, MIDI Song and metronome playback.
- 15** TRANSPOSE buttonsPage 61
For transposing the pitch in semitone steps.
- 16** LIVE CONTROL (view/knobs/sliders) ..Pages 26, 62
For controlling sounds in real time.

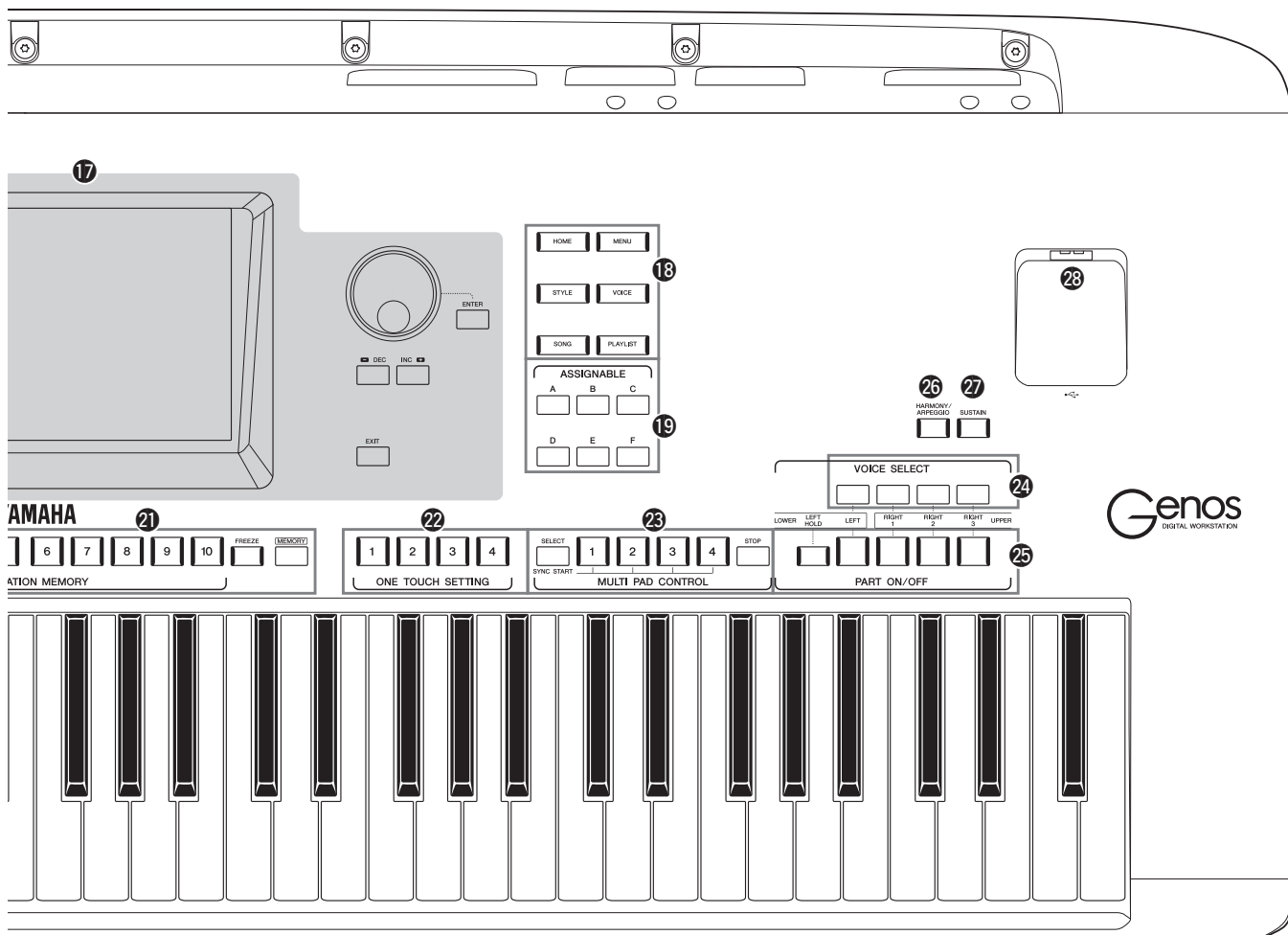

- 17 Touch LCD and related controls Page 30**
- 18 Gateway buttons..... Page 28**
For calling up the Home display and other particular displays directly.
- 19 ASSIGNABLE buttons Page 100**
For assigning shortcuts to often used functions.
- 20 DIRECT ACCESS button Pages 36, 118**
For instantly calling up the desired display with just a single additional button press.
- 21 REGISTRATION MEMORY buttons Page 92**
For registering and recalling panel setups.
- 22 ONE TOUCH SETTING buttons..... Pages 47, 60**
For calling up the appropriate panel settings for the Style.
- 23 MULTI PAD CONTROL buttons..... Pages 59, 70**
Selects and plays a rhythmic or melodic Multi Pad phrase.
- 24 VOICE SELECT buttons Page 52**
Selects a Voice for each of the keyboard parts.

- 25 PART ON/OFF buttons Page 48**
Turns each of the keyboard parts on or off.
- 26 [HARMONY/ARPEGGIO] button Page 56**
Applies the Harmony or Arpeggio to the right-hand Voices.
- 27 [SUSTAIN] button Page 67**
Applies the Sustain to the right-hand Voices.
- 28 [USB TO DEVICE] terminal..... Page 111**
For connecting a USB flash drive.

Panel Setup (Panel Settings)

By using the controls on the panel, you can make various settings as described here. These settings of the instrument are together referred to as “panel setup” or “panel settings” in this manual.

■ Rear Panel and Bottom

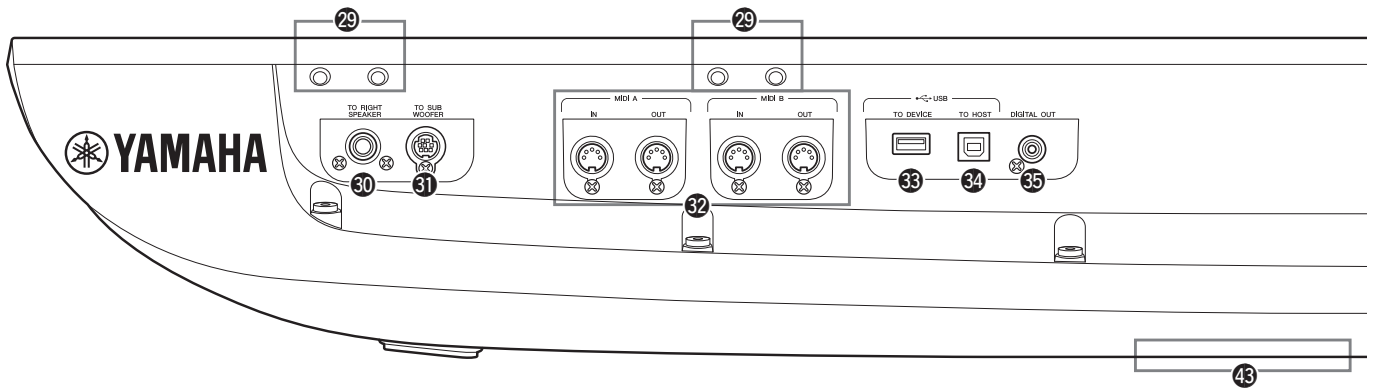

- 29 Slots** Pages 20, 116
The four slots nearest the display panel are for connecting the music rest brackets; the other slots are for connecting the speaker brackets of the optional GNS-MS01 speakers.
- 30 [TO RIGHT SPEAKER] jack**..... Page 116
For connecting an optional set of speakers.
- 31 [TO SUB WOOFER] terminal**..... Page 116
For connecting an optional set of speakers.
- 32 MIDI terminals**..... Page 113
For connecting external MIDI devices.
- 33 [USB TO DEVICE] terminal** Page 111
For connecting a USB flash drive.
- 34 [USB TO HOST] terminal**..... Page 113
For connecting to computer, or an optional wireless MIDI adaptor.

- 35 [DIGITAL OUT] jack**..... Page 109
For connecting audio devices such as a stereo system.
- 36 ASSIGNABLE FOOT PEDAL jacks** Page 110
For connecting footswitches and/or foot controllers.
- 37 LINE OUT jacks** Page 108
For connecting audio devices such as a stereo system.
- 38 AUX IN jacks**..... Page 109
For connecting audio devices such as a portable audio player.
- 39 MIC INPUT jack** Page 106
Combo jack for connecting a microphone.
(The combo jack accepts either XLR or 1/4" phone plug connectors.)
- 40 [+48V] switch**..... Page 106
Turns on and off the phantom power. When you turn this switch on, phantom power will be supplied to the

Attaching the Music Rest

- 1** Attach the two music rest brackets to the inside slots on the rear panel.
- 2** Attach the music rest to the brackets.

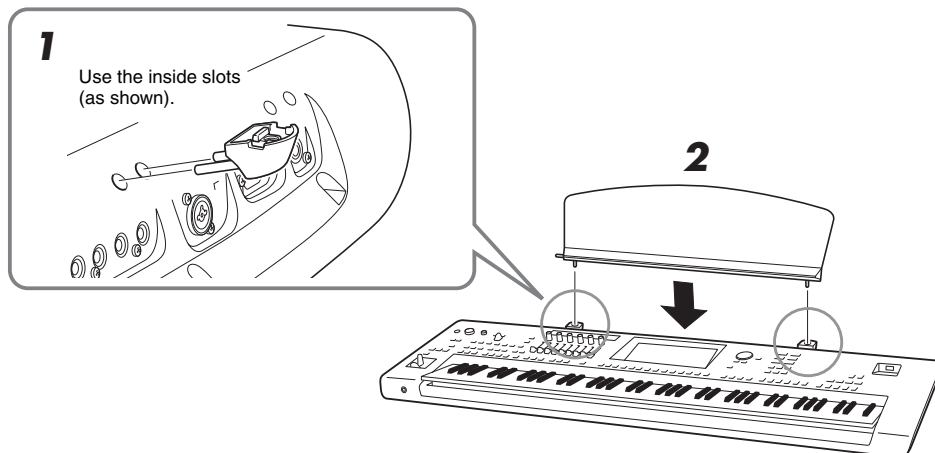

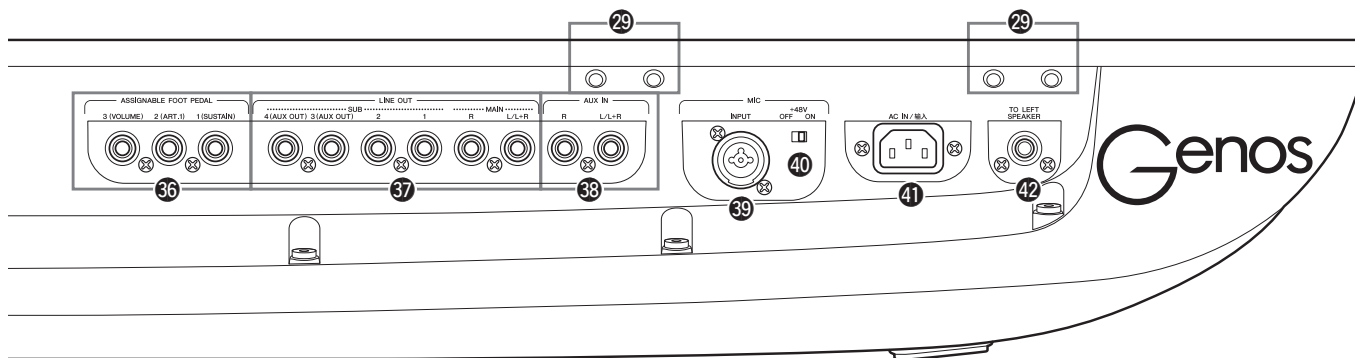

XLR jack connected to the MIC INPUT jack. Only turn this switch on/off after connecting a phantom powered condenser microphone to the device. Always turn the phantom power switch to OFF when it is not required.

NOTICE

When using phantom power, observe the following to prevent noise and possible damage to Genos or connected equipment.

- Do not connect or disconnect any devices while the phantom power switch is ON.
- Set all output level controls to the minimum before turning the phantom power switch to ON or OFF.
- When connecting a device not requiring phantom power to the MIC INPUT jack, make sure to turn the phantom power switch to OFF.

NOTE

When the phantom power switch is turned on and off, the input from MIC INPUT jack will be muted a few seconds.

- 41 AC IN jack** Page 23
For connecting the supplied power cord.
- 42 [TO LEFT SPEAKER] jack** Page 116
For connecting an optional set of speakers.
- 43 [USB TO DEVICE] terminal**
(underneath the instrument).....Pages 21, 111
For connecting a USB flash drive. For information about opening/closing the cover, see below.

Using the USB TO DEVICE terminal underneath the instrument

Genos has a convenient extra USB TO DEVICE terminal underneath the instrument, allowing you to semi-permanently install USB flash drive that will always be available and be protected from harm or loss.

Before following the steps below, make sure you have a Philips screwdriver. Also, before using a USB flash drive, refer to “Connecting USB Devices” on page 111.

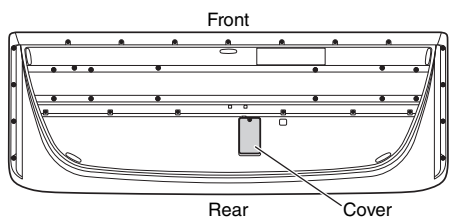

1 Remove the screw from cover.

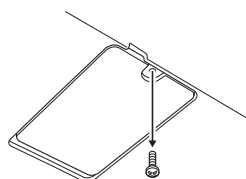

NOTE

Keep the removed screw in a safe space. It will be used when closing the cover.

2 Open the cover.
The USB TO DEVICE terminal appears.

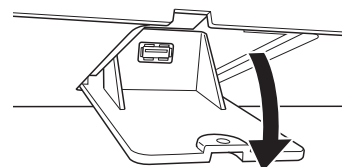

- 3** Connect the USB flash drive.
- 4** Close the cover, and tighten the screw removed in Step 1.

Starting Up

Audio Connections

Connecting headphones or a speaker system

Since the instrument has no built-in speakers, you'll need to use external equipment, such as headphones or a speaker system, to hear the sound of the instrument.

■ Using headphones

Connect a set of headphones to the [PHONES] jack.

■ Using a speaker system

For instructions on installing the optional speakers GNS-MS01, refer to page 116. For instructions on connecting other speakers, refer to page 108.

CAUTION

Do not listen with the headphones at high volume for long periods of time. Doing so may cause hearing loss.

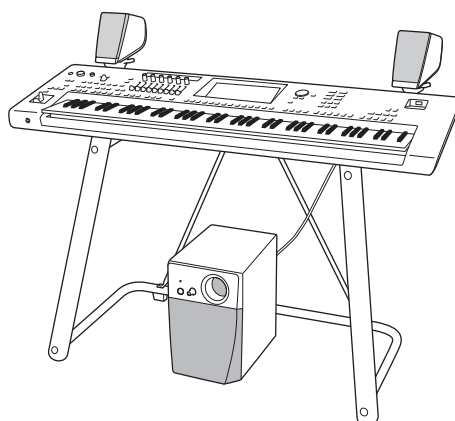
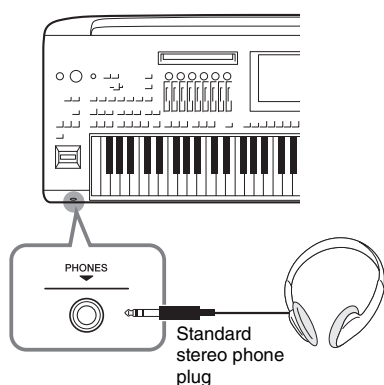

Shown here is the optional L-7B Keyboard Stand.

Connecting a microphone

By connecting a microphone to the [MIC INPUT] jack (either XLR or standard 1/4" phone plug connectors), you can sing along with your keyboard performance or with Song playback. For instructions on connecting a microphone, refer to page 106.

Power Supply

- 1 Connect the supplied power cord to the [AC IN] jack on the instrument's rear panel.

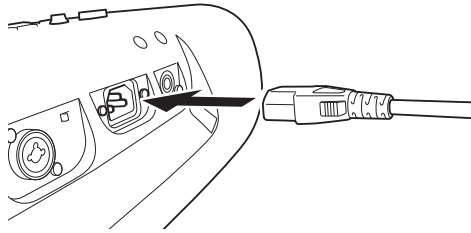

- 2 Connect the other end of the power cord to an AC outlet.

WARNING

Use only the supplied power cord.

CAUTION

When setting up the product, make sure that the AC outlet you are using is easily accessible. If some trouble or malfunction occurs, immediately turn off the power switch and disconnect the plug from the outlet.

NOTE

When disconnecting the power cord, first turn off the power, then follow this procedure in reverse order.

Turning the Power On/Off

- 1 Turn down the [MASTER VOLUME] dial to "MIN."

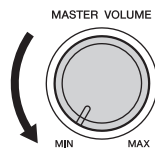

- 2 Press the [⏻] (Standby/On) switch to turn the power on.

The Home display (page 30) appears. Adjust the volume as desired while playing the keyboard.

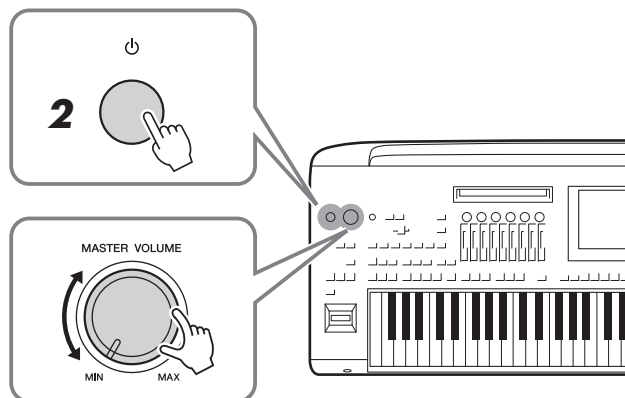

- 3 After you finish using the instrument, turn off the power by pressing and holding the [⏻] (Standby/On) switch for about a second.

NOTE

Until the Home display appears, no operations can be carried out, including power-off and keyboard performance.

CAUTION

Even when the power switch is turned off, electricity is still flowing to the product at the minimum level. When you are not using the product for a long time, make sure to unplug the power cord from the wall AC outlet.

NOTICE

When recording or editing, or while a message is displayed, the power cannot be turned off even if you press the [⏻] (Standby/On) switch. If you want to turn off the power, press the [⏻] (Standby/On) switch only after recording, editing, or after the message has disappeared. If you need to force-quit the instrument, hold down the [⏻] (Standby/On) switch for longer than three seconds. Note that the force-quit operation might cause data loss and damage to the instrument.

Auto Power Off and Auto Power Saving functions

To prevent unnecessary power consumption, this instrument features an Auto Power Off function that automatically turns the power off if the instrument is not operated for a specified period of time. The amount of time that elapses before the power is automatically turned off is approximately 30 minutes by default; however, you can change the setting (page 25).

This instrument also features an Auto Power Saving function that automatically decreases brightness of the LIVE CONTROL view if the instrument is not operated for a specified period of time. The amount of time that elapses before the brightness decreases is approximately 5 minutes by default; however, you can change the setting (page 25).

NOTICE

Any data which is not saved via the Save operation will be lost if the power automatically turns off. Make sure to save your data before this happens.

NOTE

When a USB flash drive containing a large number of files is connected to the instrument, the execution of the Auto Power Off function or the Auto Power Saving function may be postponed, since the file search index is automatically updated.

Disabling Auto Power Off and Auto Power Saving (simple method)

Turn the power on while holding down the lowest key on the keyboard. A message appears briefly and Auto Power Off and Auto Power Saving are disabled.

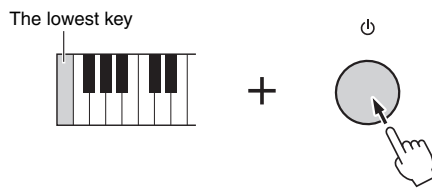

Making Basic Settings

As necessary, make basic settings for the instrument, such as the language shown on the display.

1 Call up the Utility operation display.

First, press the [MENU] button to call up the Menu display. Then touch [Menu 2] to move to page 2 on the display (if necessary), and touch [Utility].

2 Touch [System] on the display.

3 Make the necessary settings by touching the display.

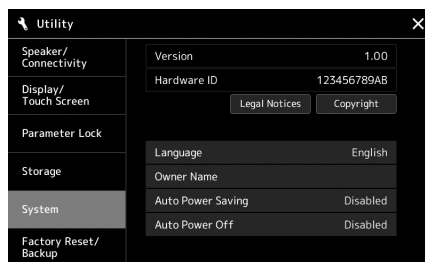

| | |
|------------|--|
| Language | Determines the language used in the display for menu names and messages. Touch this setting to call up the language list, then select the desired one. |
| Owner name | Lets you input your name which appears in the opening display (called up when the power is turned on). Touch this setting to call up the character entry window, then input your name (page 40). |

| | |
|-------------------|--|
| Auto Power Saving | Lets you set the amount of time that elapses before the Auto Power Saving function decreases brightness of the LIVE CONTROL view. Touch this to call up the list of settings, then select the desired one. To disable Auto Power Saving, select “Disabled” here. |
| Auto Power Off | Lets you set the amount of time that elapses before the power is turned off by the Auto Power Off function (page 24). Touch this to call up the list of settings, then select the desired one. To disable Auto Power Off, select “Disabled” here. |

For information on the other items in this display, refer to the Reference Manual on the website (page 10).

Changing the Brightness of Lighting Buttons

Here you can change the brightness of the lighting buttons.

1 Call up the operation display (Utility) (step 1 on page 24).

2 Call up page 2/2 of the “Display/Touch Screen” display.

First, touch [Display/Touch Screen] on the display. Then touch [▼] to move to page 2 on the display.

3 Change the settings by touching the display.

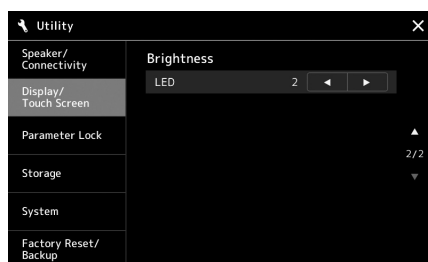

| | |
|-----|---|
| LED | Touch [◀]/[▶] to adjust the brightness of the lighting buttons. |
|-----|---|

Display Structure

Genos has two displays (the LCD Touch Screen and the LIVE CONTROL view) and lighting buttons for visually helping you to understand the current status.

LIVE CONTROL view (Sub Display)

The LIVE CONTROL view indicates the parameters operated when you use the six LIVE CONTROL knobs and nine LIVE CONTROL sliders. For details on the display structure, see page 27.

LCD (Main Display; touch screen)

The LCD indicates the parameters and values related to the currently selected operation. You can operate by touching the “virtual” buttons or sliders on the display. For details on the display structure, see page 28.

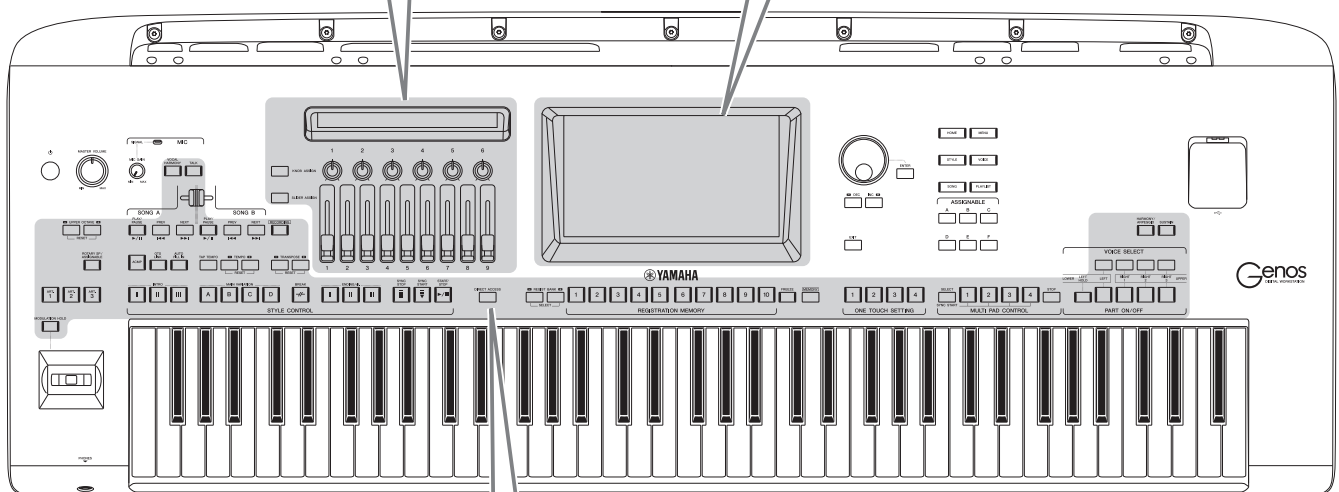

Lighting buttons

These buttons indicate the corresponding function statuses by lighting on/off, flashing, or changing colors. For details on the lighting indications and conventions, refer to each description of the functions.

LIVE CONTROL View (Sub Display) Structure

In the LIVE CONTROL view, you can see the parameters status controlled by the LIVE CONTROL knobs and the LIVE CONTROL sliders. There are two displays: knobs and sliders, and you can switch between these two displays while operating the instrument. To switch between the displays without changing parameter values, simply press the [KNOB ASSIGN]/[SLIDER ASSIGN] buttons.

NOTE

Pressing the [KNOB ASSIGN] button while the knobs display is already shown or pressing the [SLIDER ASSIGN] button while the sliders display is already shown switches the Assign Type of the corresponding controller group. For details on switching Assign Types, see page 62.

The LIVE CONTROL knobs display

Displays number of Knob Assign Type (page 62)

| | | | | | | |
|---|--------|-----------|--------|---------|--------|--------|
| 1 | Cutoff | Resonance | Attack | Release | Reverb | Chorus |
| | 0 | 0 | 0 | 0 | 17 | 0 |

Displays parameter currently being controlled by corresponding knob.

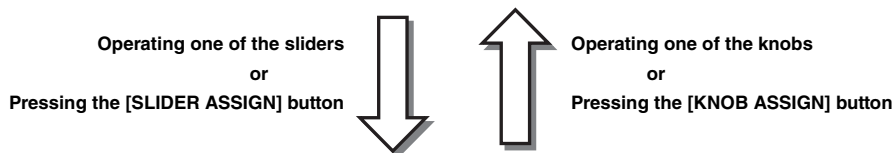

The LIVE CONTROL sliders display

Displays number of Slider Assign Type (page 62)

| | | | | | | | | | |
|---|-------|-------|------|--------|--------|--------|-------|-------|-----|
| 2 | Style | M.Pad | Left | Right1 | Right2 | Right3 | SongA | SongB | Mic |
| | 100 | 100 | 100 | 100 | 100 | 100 | 85 | 100 | 100 |

Displays parameter currently being controlled by corresponding slider.

Main Display Structure—Using the Gateway Buttons

The Gateway buttons are just as their name suggests—a convenient, easy-to-understand “gateway” to Genos. When the instrument is turned on, the Home display is called up. However, as you operate the instrument, you can directly call up the Home display and other desired displays directly by pressing the Gateway buttons on the front panel. Other functions and various detailed settings for the instrument can be accessed from the Menu display. Also, depending on the particular function, you can call up the File Selection display to select desired files.

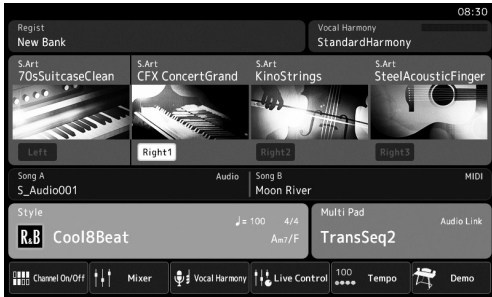

Home display

This is portal of the instrument’s display structure, which provides at-a-glance information on all current settings.

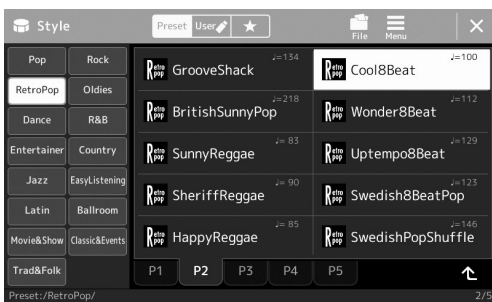

Style Selection display

This is a type of “File Selection” display (page 32) for selecting Styles.

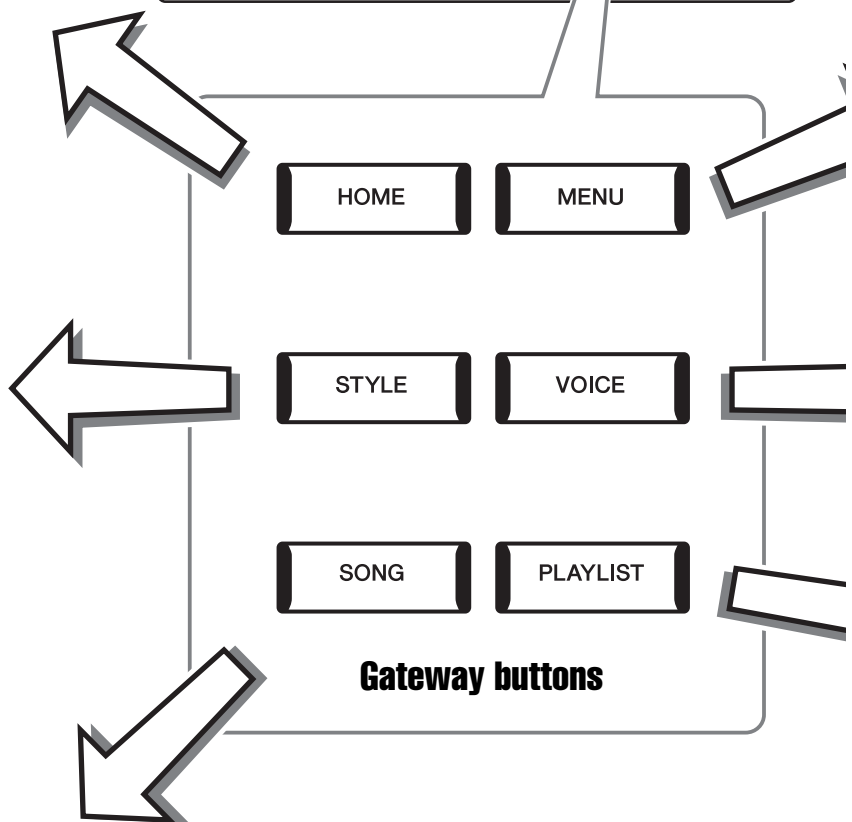
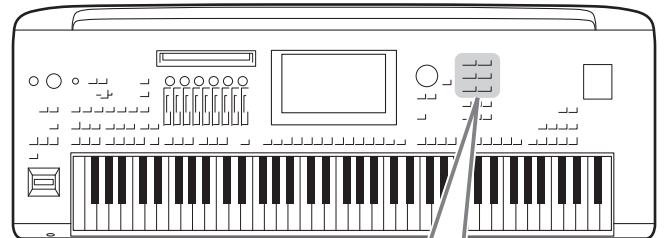

Gateway buttons

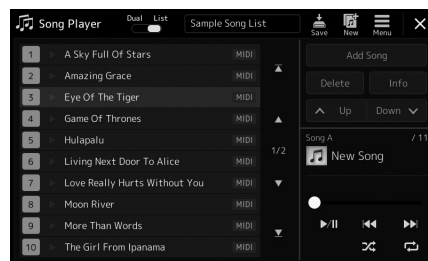
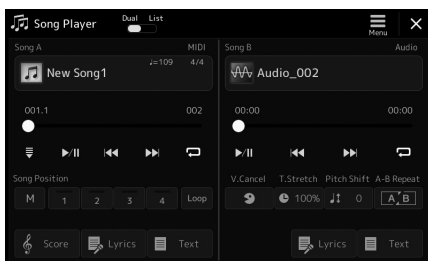

Song Playback display

This is for controlling Song playback (pages 72, 78.)

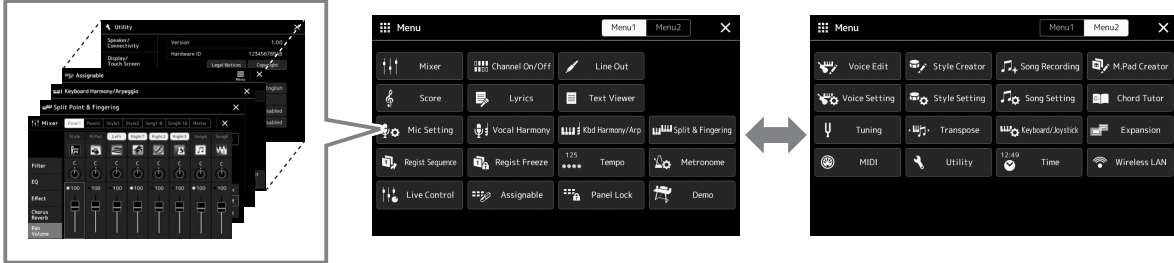

Menu display

By touching each of the icons, you can call up various functions, such as Song Score, Volume Balance and other detailed settings. (page 33)



Voice Part Setup display

This is for making detailed settings such as Voice Edit and Effect settings of the keyboard parts. For details on the Voice Part Setup display, refer to the Reference Manual on the website.

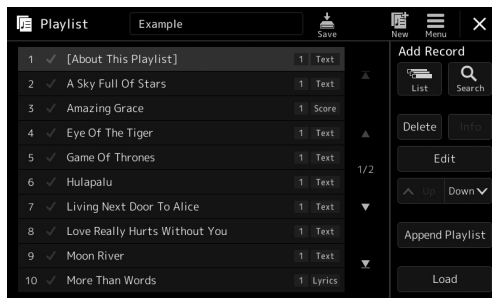
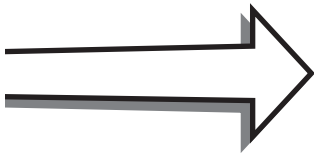

Playlist display

This is for selecting and editing Playlists (page 96.)

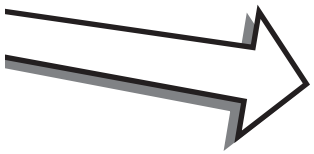

RECORDING

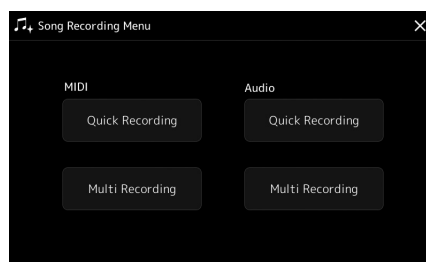
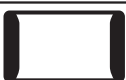

Song Recording display

This is for recording your performance (page 90.)

Basic Operations

Display Configuration

This section covers the most often used displays: Home, File Selection and Menu. The Home display appears when the power is turned on. The term “File Selection display” refers to all the various displays called up on the instrument from which you can select files. The Menu display is a portal display for various functions and can be called up by pressing the [MENU] button.

Home Display

Appears when the power is turned on, and can be called up when the [HOME] button is pressed. This display shows the current basic settings such as the current Voice and Style, allowing you to see them at a single glance. Because of this, you should normally have the Home display shown when you perform on the keyboard.

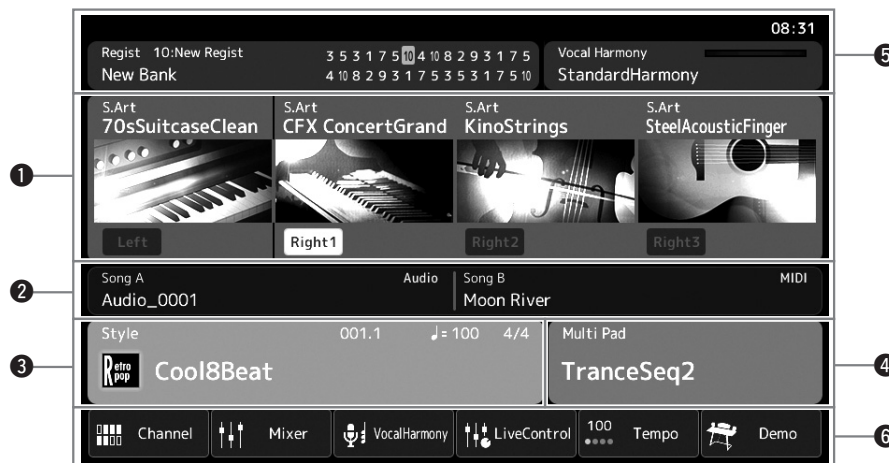

1 Voice area

Indicates the current Voices for each of the keyboard parts (Left and Right 1–3) and the on/off status of the four parts. Touching a Voice name calls up the Voice Selection display for the corresponding part.

2 Song area

Indicates information for the current Song(s). Touching a Song name calls up the Song Selection display.

3 Style area

Indicates information for the current Style, the current position (bar/beat/tempo), the current chord name, and the time signature. Touching a Style name calls up the Style Selection display. When the [ACMP] button is set to on, the chord specified in the chord section of the keyboard will be displayed.

4 Multi Pad area

Indicates the current Multi Pad Bank. Touching a Multi Pad Bank name calls up the Multi Pad Bank Selection display.

5 Information area

Indicates the current status such as microphone-related information, the current Registration Memory. For details, see the next page.

6 Shortcut area

Contains the shortcut icons which let you call up various functions with a single touch. Touching a shortcut icon calls up the display of the corresponding function. You can also register your own custom shortcut icons as desired here, via the Assignable display (page 100).

■ Information area in the Home display

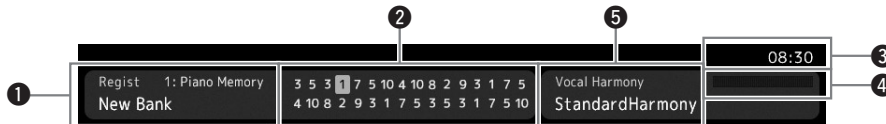

❶ Registration Memory Bank

Indicates the currently selected Registration Memory Bank name and Registration Memory number. Touching a Registration Memory Bank name calls up the Registration Memory Bank Selection display.

❷ Registration Sequence

Appears when the Registration Sequence is active. For instructions on programming the sequence, refer to the Reference Manual on the website.

❸ Clock

The current time is shown here.

❹ MIC Input level indicator

When a microphone is connected, this indicates the input level. Adjust the level with the [MIC GAIN] knob so that the indicator lights in green or yellow (but not in red). For details on connecting a microphone, refer to page 106.

❺ Vocal Harmony Type name

Indicates the current Vocal Harmony Type (page 76). Touching a Vocal Harmony Type name calls up the Vocal Harmony Type Selection display.

File Selection Display

The File Selection display is for selecting a Voice, Style, Song, Multi Pads and other items. You can call up this display by touching the name of the Voice, Style or Song on the Home display, or by pressing one of the VOICE SELECT buttons or [STYLE] button, etc. The displays are different, depending on which file type is selected. For example, when Voice is selected, the Voice Selection display is called up.

This section explains the display structures common to all types of the File selection displays.

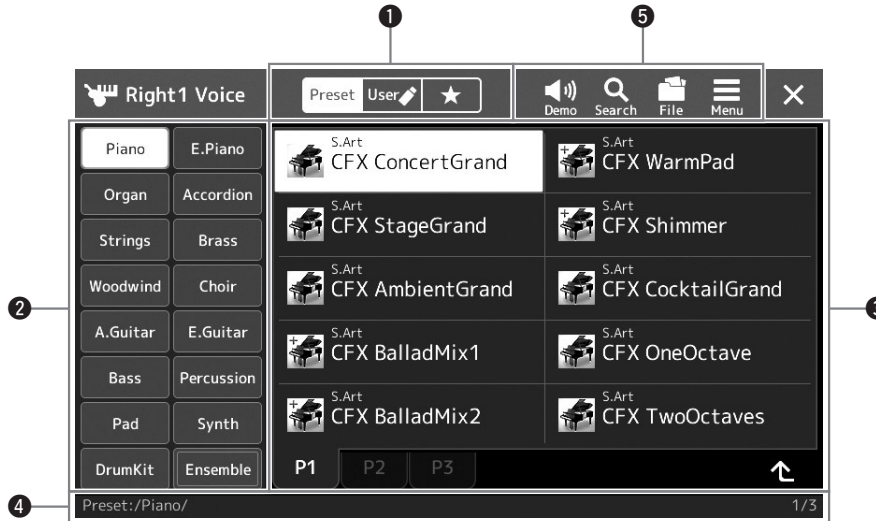

1 Main Category

Select the Preset, User, or Favorite tab.

| | |
|----------|--|
| Preset | Location where preset data are shown. A wide variety of data such as Voices and Styles are divided into several sub categories (tabs). |
| User | Location where recorded or edited data is saved. Data saved to the instrument are shown in "User" (User drive), while data in the connected USB flash drive are shown in "USB." In this manual, data in the User tab are referred to as "User data." |
| Favorite | Location where the data which you have registered as Favorites are shown. This tab may not be shown depending on the data type. |

2 Sub Category / Drives

- When the Preset tab is selected in the main categories, the sub categories are shown here according to the data type. For example, various instrument types such as Piano and Organ are shown on the Voice Selection display.
- When the User tab is selected, the drives available are shown as sub categories.

3 Selectable data (files)

The files that can be selected are shown. If two or more pages are available, you can call up another page by touching the desired page tab at the bottom of this area.

4 Folder Path

The current path or folder is shown here according to the folder structure.

5 Operation icons

The functions (save, copy, delete, etc.) which can be operated via the File Selection display are shown.

The icons shown here differ depending on which File Selection display is selected. For detailed instructions, refer to "File Management" (page 37), or the instructions for each function's File Selection display.

Menu Display

This is the portal display for using various functions and can be called up by pressing the [MENU] button.

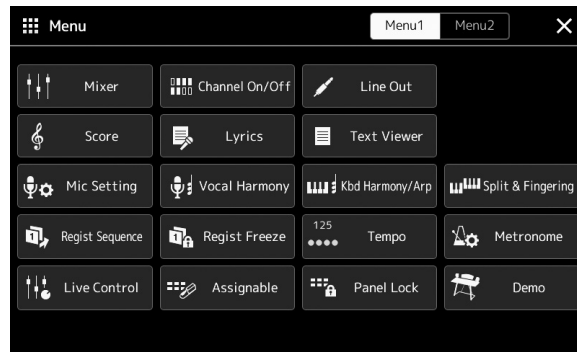

Various convenient functions are shown via icons. Touching each of them calls up the corresponding function. This list consists of two pages, which you can select by touching [Menu 1] or [Menu 2].

For brief information on each function, refer to the “Function List” (page 114).

 **NOTE**

You can also change pages by flicking horizontally.

Instruction conventions for the Menu display

Throughout this manual, instructions with multiple steps are given in convenient shorthand, with arrows indicating the proper sequence.

Example: [MENU] → [Utility] → [System] → [Language]

The example above describes a four step operation:

- 1) Press the [MENU] button to call up the Menu display.
- 2) From the Menu display, Touch [Utility].
- 3) Touch [System].
- 4) Touch [Language].

Closing the Current Display

To close the current display, press the [EXIT] button or touch  at the upper right of the display (or window) or [Close] at the lower right of pop-up displays. When a message (information or confirmation dialog) appears, touching the appropriate item such as “Yes” or “No” closes the message.

If you want to quickly return to the Home display, press the [HOME] button on the panel.

Display-based Controls

The display of this instrument is a special touch screen that allows you to select or change the desired parameter by simply touching the corresponding setting on the display. You can also decrease/increase the value in small steps by rotating the Data dial or pressing the [DEC]/[INC] button.

Using the display (touch screen)

NOTICE

Do not use any sharp or hard tools to operate the touch screen. Doing so may damage the display.

NOTE

Keep in mind that operation by simultaneously touching two or more points on the display is not possible.

Touch

To select an item, lightly touch the corresponding indication on the display.



NOTE

If you find the system sounds (produced when touching the display) distracting, you can turn them on/off from [MENU] → [Utility] → [Display/Touch Screen] → Touch Screen [Sound]

Slide

Hold down the display slider, then slide your finger vertically or horizontally to change the parameter value.



Rotate

Touch and hold the display knob, and rotate your finger around the knob to change the parameter value.



Touch and hold

This instruction means to touch the object in the display and hold it for a while.

When setting values by using the [◀]/[▶] buttons, a slider or a knob, you can restore the default value by touching and holding the value on the display.



Using the Data dial, [ENTER] button, and [DEC]/[INC] buttons

Depending on the display, the Data dial and the buttons can be used in the following three ways.

■ Adjusting the parameter values

After selecting the desired parameter, use the Data dial or the [DEC]/[INC] buttons to adjust the value. This is useful if you have difficulty adjusting by touching on the display, or want finer control over the adjustment.

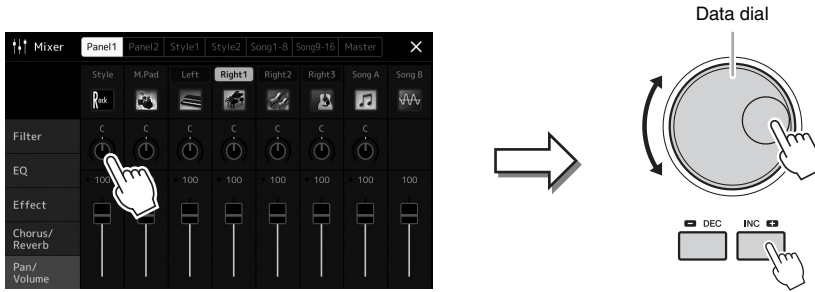

■ Selecting an item from a list without a cursor

When a list not having a cursor, such as pop-up windows for setting parameters, use the Data dial and the [DEC]/[INC] buttons to select an item.

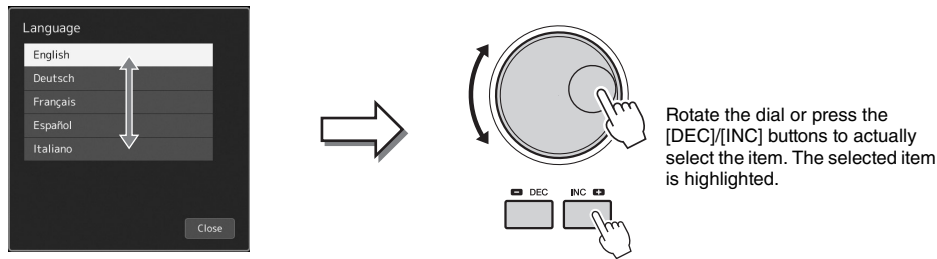

Calling up the Desired Display Instantly—Direct Access

With the convenient Direct Access function, you can instantly call up the desired display—with just a single additional button press. Refer to the “Direct Access Chart” on page 118 for a list of the displays that can be called up with the Direct Access function.

1 Press the [DIRECT ACCESS] button.

A message appears in the display prompting you to press the appropriate button.

2 Press the button (or move the knob, slider, joystick or connected pedal) corresponding to the desired setting display to instantly call up that display.

For example, pressing one of the REGISTRATION MEMORY [1]–[10] buttons calls up the Regist Bank Info display (page 95).

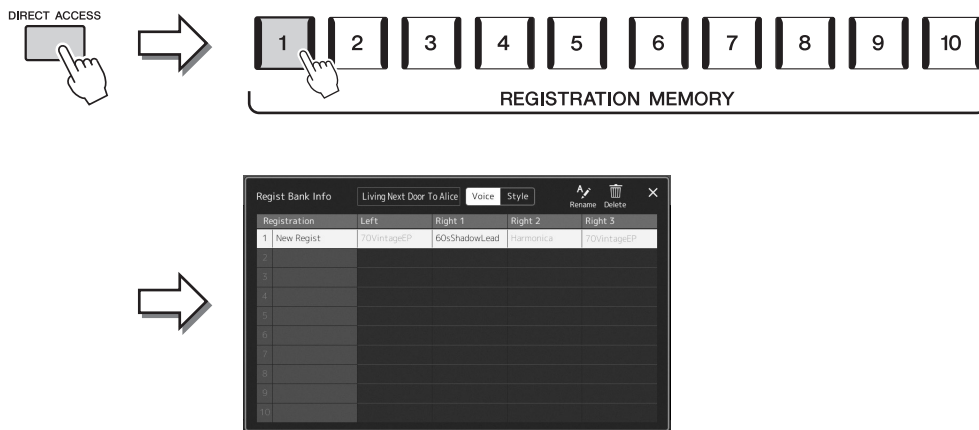

Playing the Demos

The Demos provide dynamic demonstrations of the high-quality sounds.

1 Call up the Demo display via [MENU] → [Demo].

2 Touch the display to show and play the desired Demo.

3 Press the [EXIT] button to exit from the Demo display.

NOTE

To return to the higher level menu, touch [Menu] on the display.

File Management

Data you have created such as recorded Song and edited Voice can be saved as files to the instrument (referred to as “User drive”) and a USB flash drive. If you’ve saved a lot of files, you may have trouble finding the desired file quickly. To make operation easier, you can organize your files in folders, rename the files, delete unnecessary files, etc. These operations are done in the File Selection display.

NOTE

Before using a USB flash drive, be sure to read “Connecting USB Devices” on page 111.

Restrictions for Preset Songs

Preset Songs are copy protected to prevent illegal copying or accidental erasure. These cannot be copied, moved, and saved to any other place, and cannot be deleted.

Saving a file

You can save your original data (such as Songs you’ve recorded and Voices you’ve edited) as a file to the User drive or the USB drive in the File Selection display (page 32).

- 1** In the relevant File Selection display (*), touch  (File Edit) to call up the File Edit pop-up window.

* For example, the display shown below (Voice Selection) is called up via VOICE SELECT [RIGHT 1] button.

NOTE

To cancel the file operation, press the [EXIT] button.

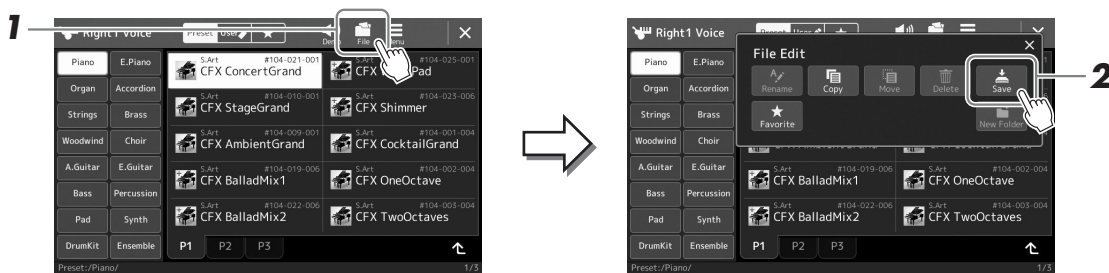

- 2** Touch [Save] to call up the display for selecting the saving destination.

- 3** Select the location to which you want to save the file.

To show the next higher level folder, touch  (Up).



- 4** Touch [Save here] to call up the Character Entry window.

- 5** Enter the file name (page 40).

Even if you skip this step, you can rename the file at any time (page 38) after saving.

NOTE

To cancel this operation, touch [Cancel].

6 Touch [OK] in the Character Entry window to actually save the file.

The saved file will be automatically located at the appropriate position among the files in alphabetical order.

Creating a new folder

Folders can be created, named and organized as desired, making it easier to find and select your original data.

1 In the File Selection display, touch the User tab (page 32) then select the location to which you want to create a new folder.

To show the next higher level folder, touch  (Up).

2 Touch (File Edit) to call up the File Edit pop-up window.

3 Touch [New Folder] to call up the Character Entry window.

4 Input the name of the new folder (page 40).

NOTE

- The maximum number of files/folders which can be stored in a folder is 2500.

NOTE

A new folder cannot be created in the Preset tab or the "Expansion" folder (page 103) in the User tab.

Renaming a file/folder

You can rename files/folders.

1 Call up the File Selection display, on which the desired file/folder is shown.

2 Touch (File Edit) to call up the File Edit pop-up window.

3 Touch [Rename] in the File Management menu, to call up the display for selecting the desired file/folder.

4 Select the desired file or folder by touching it.

5 Touch [Rename] at the top of the display to call up the Character Entry window.

6 Input the name of the selected file or folder (page 40).

NOTE

Files in the Preset tab or the "Expansion" folder (page 103) in the User tab cannot be renamed.

NOTE

Only one file or folder can be renamed at a time.

Copying or moving files

You can copy or cut a file and paste it to another location (folder). You can also copy a folder (without move it) by using the same procedure.

1 Call up the appropriate File Selection display, on which the desired files/folders are shown.

2 Touch (File Edit) to call up the File Edit pop-up window.

3 Touch [Copy] or [Move] in the File Management menu, to call up the display for selecting the desired files/folders.

NOTE

- Files in the Preset tabs cannot be copied/moved.
- Files in the "Expansion" folder (page 103) in the User tab cannot be copied/moved.

4 Select the desired files/folders by touching each item.

One or more files/folders can be selected (highlighted). To cancel the selection, touch the same item again.

Touch [Select All] to select all items indicated on the current display including the other pages. To cancel the selection, touch [All Off].

5 Touch [Copy] or [Move] at the top of the display, to call up the display for selecting the destination.**6 Select the desired destination (path) to paste the files/folders.****7 Touch [Copy here] or [Move here] to paste the files/folders you've selected in step 4.**

The pasted file/folder appears on the display at the appropriate position among the files in alphabetical order.

NOTE

To cancel this operation, touch [Cancel] before going to step 7.

Deleting Files/Folders

You can delete files/folders.

1 Call up the appropriate File Selection display, on which the desired files/folders are shown.**2 Touch  (File Edit) to call up the File Edit pop-up window.****3 Touch [Delete] in the File Management menu, to call up the display for selecting the desired files/folders.****4 Select the desired files/folders by touching each item.**

One or more files/folders can be selected (highlighted). To cancel the selection, touch the same item again.

Touch [Select All] to select all items indicated on the current display including the other pages. To cancel the selection, touch [All Off].

5 Touch [Delete] at the top of the display.

A confirmation message appears. To cancel this operation, touch [No] before going to step 6.

6 Touch [Yes] to actually delete the files/folders you've selected in step 3.**NOTE**

Files in the Preset tabs or the "Expansion" folder (page 103) in the User tab cannot be deleted.

Registering files to the Favorite tab

You can call up your favorite or often used Style or Voice files quickly by registering them to the Favorite tab. For details, refer to the Reference Manual on the website (page 10).

Searching for files

You can search for desired files by name, on the display called up via touching  (File Search). In the case of Registration Memory Bank files, you can also search for them by specifying other detailed properties. For details, refer to the Reference Manual on the website (page 10).

Entering Characters

This section covers how to enter characters for naming your files/folders, inputting keywords on searching file, etc. Entering characters is done in the display shown below.



1 Touch the character type.

Touching [Symbol] (or [abc]) switches between entering symbols or Roman letters (and numbers).

To switch between entering capital letters or small letters, touch  (Shift).

2 Touch [**◀**]/[**▶**], rotate the Data dial or the press [DEC]/[INC] buttons to move the cursor to the desired location.

3 Input the desired character one by one.

To delete a single character, touch [Delete]; to delete all characters at once, touch and hold [Delete]. To enter a space, touch the space key indicated in the illustration above.

To input letters with auxiliary symbols:

You can input letters with auxiliary symbols such as an umlaut by touching and holding a letter to call up a list. For example, touch and hold “E” to enter “Ë” from the list.

To select custom icons for files (shown at left of file name):

You can select custom icons for the file. Touch [Icon] to call up the pop-up window, then select the desired icon.

4 Touch [OK] to finalize the characters (name, keywords, etc.) you have input.

NOTE

- Depending on the display for character entry you are working in, some types of characters cannot be entered.
- A file name can contain up to 46 characters and a folder name can contain up to 50 characters.
- The following characters (half size) cannot be used: \ / : * ? " < > |

NOTE

To cancel this operation, touch [Cancel] before going on to step 4.

Locking the Panel Settings (Panel Lock)

When the panel settings are locked, nothing happens if you press any panel buttons. For example, when you take a break during your performance and leave the instrument unattended, this feature protects the panel settings from being accessed by others.

- 1 Call up the Panel Lock display via [MENU] → [Panel Lock].**
The numeric keypad for PIN code entry is called up.
- 2 Input a four-number PIN code by touching the numeric keypad, then touch [OK] to enter it.**
The panel settings are locked. The main display is also in a lock mode during the panel lock.
- 3 To unlock the instrument, touch the display, then input the same PIN code you entered in step 2.**

 **NOTE**

If you have forgotten the PIN code, simply turn the power off and back on again to unlock the instrument.

Using the Metronome

The metronome provides a click sound, giving you an accurate tempo guide when you practice, or letting you hear and check how a specific tempo sounds. When recording without Style playback, turning the metronome on makes your recording sessions much more efficient.

- 1 Call up the Metronome display via [MENU] → [Metronome].**

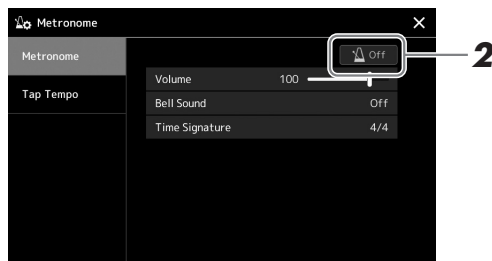

- 2 Touch the icon to turn the metronome On/Off.**

For information on the other items on the display, refer to “Metronome Settings” of the Reference Manual on the website.

 **NOTE**

The Metronome can also be turned on/off by touching the Metronome On/Off button on each recording display. (page 90)

Quick Guide—For Performing on Genos

■ Manual panel settings and performing a single song

Playing the keyboard with Styles (Auto Accompaniment)

Setting up the Style
... p. 44

Optimum panel settings for the current Style (One Touch Setting) ... p. 47

Calling up the most appropriate panel settings (Keyboard Parts, Harmony/Arpeggio, or Multi Pads) for the selected Style.

or

Setting up the Voices ... p. 48
(Setting up keyboard parts)

Setting up Harmony/Arpeggio ... p. 56

Singing with Song playback

Making Song playback settings ... p. 72

■ Storing the song's panel settings for easy recall

Storing the song's panel settings to Registration Memory ... p. 93

For details about Registration Memory and Registration Banks, refer to page 92.

■ Calling up the stored panel settings for your performance

Selecting the desired Registration Bank file

Calling up the Registration Memories 1–10 for the Bank file. (p. 94)

Calling up the desired song's panel settings from the Playlist in a single step

Selecting the desired Playlist Record for calling up the corresponding linked Registration Memory. (p. 97)

■ Recording your keyboard performance

Recording setup: Calling up a Registration Memory from the Playlist, etc.

Setting up Multi Pads ... p. 59

Assigning functions to controllers ... p. 62

Setting up Vocal Harmony ... p. 76

Playing with Styles
Operations during performance: p. 64

Assigning functions to controllers ... p. 62

Setting up Vocal Harmony ... p. 76

Singing with Song playback
Operations during performance: p. 78

Registering the Registration Memory in a Playlist ... p. 96
Creating a Playlist Record as a shortcut to the Registration Memory.

Editing the Playlist for your live performance set list ... p. 98
Creating a new Playlist for your live performance by selecting Songs from a preset Playlist.

Selecting the desired Registration Memory
Calling up the desired panel settings by pressing the Registration Memory 1–10. (p. 94)

Playing with Styles or Singing with Song playback

Further recording setup
MIDI Quick Recording ... p. 90
Audio Quick Recording ... p. 91

Recording Your performance
Recording your playing and/or singing.

Playing with Styles—Setups

This section gives you basic steps on how to enhance your keyboard performance with Styles (Rhythm and Auto Accompaniment). Go through the various instructions below to completely set up your performance of a single song: Style, Keyboard Part (Voice), Multi Pad, and various types of controllers.

The settings made in this section can be collectively stored in the Registration Memory as one song setting (page 92).

Setting up Styles

Selecting the desired Style and turning Auto Accompaniment (ACMP) on

- 1 Press the [STYLE] button to call up the Style Selection display.

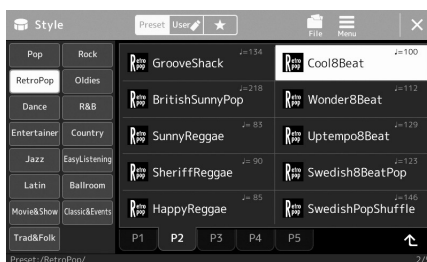
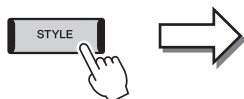

NOTE

You can also call up the Style Selection display via the Home display (page 30).

- 2 Touch the desired Style.

For example, touch the category [Country], and then [Country Folk 8beat].

- 3 Make sure that the STYLE CONTROL [ACMP] button is turned on.

When the button is turned on, both the rhythm part and auto accompaniment can be played back during Style playback.

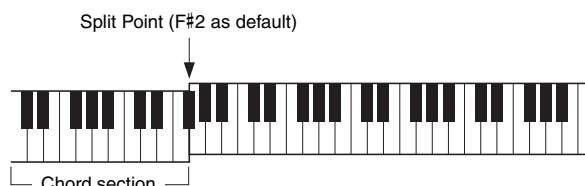
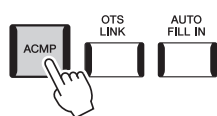

At the same time, the specific left-hand section of the keyboard can be used as the Chord section, and chords played in this section are automatically detected and used as a basis for fully automatic accompaniment with the selected Style.

- 4 If necessary, try out the selected Style.

Press the STYLE CONTROL [] (SYNC START) button, then play chords with your left hand.

To stop Style Playback, press the STYLE CONTROL [] (START/STOP) button.

NOTE

For basic operations of the Style Selection display, refer to “File Selection Display” (page 32).

NOTE

The Split Point can be changed as desired (page 49).

NOTE

For more details on operating Style playback, refer to page 64.

Style Characteristics

The particular type of Style is indicated the upper left of the Style name in the Style Selection display. The defining characteristics of these Styles and their performance advantages are described below.

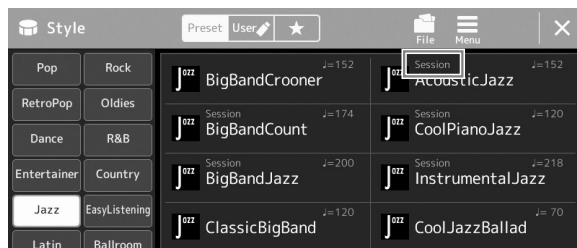

- **Session:** These Styles provide even greater realism and authentic backing by mixing in original chord types and changes, as well as special riffs with chord changes, with the Main sections. These have been programmed to add “spice” and a professional touch to your performances of certain songs and in certain genres. Keep in mind, however, that the Styles may not necessarily be appropriate—or even harmonically correct—for all songs and for all chord playing. In some cases for example, playing a simple major triad for a country song may result in a “jazzy” seventh chord, or playing an on-bass chord may result in inappropriate or unexpected accompaniment.
- **Free Play:** These Styles are characterized by rubato performance. You can perform freely with remarkably expressive accompaniment, without being constrained by a strict tempo.
- **DJ:** These contain their own special chord progressions, so you can add chord changes to your performance simply by changing the root key. The Multi Pad (page 59) data in the “DJ Phrase” category are specially created for these Styles. You can call up the suitable Multi Pads by using the One Touch Setting function (page 47).

NOTE

- You cannot specify the chord type, such as major and minor, when using the DJ Styles.

For the Preset Style List, refer to the Data List on the website.

A Style generally consists of eight parts (channels): rhythm, bass, etc. You can add variations and change the feeling of a Style by selectively turning channels on/off or by changing the Voices (page 88).

Style File Compatibility

This instrument uses the SFF GE file format (page 11) and can play back existing SFF files; however, they will be saved in the SFF GE format when the file is saved (or loaded) in this instrument. Keep in mind that the saved file can only be played back on instruments that are compatible with the SFF GE format.

Adjusting the tempo

The TEMPO [-] and [+] buttons let you change the playback tempo of the Metronome, Style and MIDI Song. The tempo of the Style and MIDI Song can also be adjusted via the [TAP TEMPO] button.

NOTE

If you want to adjust the tempo of an Audio Song, use the Time Stretch function on page 80.

● TEMPO [-]/[+] buttons

Press the TEMPO [-] or [+] button to call up the Tempo pop-up display. Use the TEMPO [-]/[+] buttons to decrease or increase the tempo over a range of 5–500 beats per minute. Holding down either button changes the value continuously. Pressing both TEMPO [-] and [+] buttons calls up the default tempo of the last selected Style or Song.

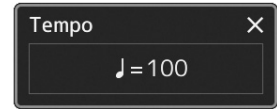

● [TAP TEMPO] button

During playback of a Style or MIDI Song, you can change the tempo by tapping the [TAP TEMPO] button twice at the desired tempo. When Style and Song are stopped, tapping the [TAP TEMPO] button (four times for a 4/4 time signature) starts playback of the rhythm part of the Style at the tempo you tapped.

Changing the Chord Fingering type

By changing the Chord Fingering type, you can automatically produce appropriate accompaniment even if you don't press all of the notes which comprise a chord. Chord fingering type can be changed via the Split Point/Fingering window: [MENU] → [Split & Fingering].

The following types can be selected, for example.

● Single Finger

This method lets you easily play chords in the accompaniment range of the keyboard using only one, two or three fingers.



Major chord

Press the root key only.



Minor chord

Simultaneously press the root key and a black key to its left.



Seventh chord

Simultaneously press the root key and a white key to its left.



Minor seventh chord

Simultaneously press the root key and both a white and black key to its left.

● Fingered

This lets you finger your own chords on the chord section of the keyboard, while the instrument supplies appropriately orchestrated rhythm, bass, and chord accompaniment in the selected Style. The Fingered type recognizes the various chord types which are listed on the Data List on the website (page 10), and can be looked up using the Chord Tutor function called up via [MENU] → [Chord Tutor].

● AI Full Keyboard

This lets you play just about anything, anywhere on the keyboard using both hands—like conventional playing of a piano—and still have appropriate accompaniment. You don't have to worry about specific ways to play/indicate the chords. (Depending on the song arrangement, AI Full Keyboard may not always produce appropriate accompaniment.)

NOTE

When the chord detection area is set to "Upper" (page 51), only "Fingered*" is available.

For other types, refer to the Reference Manual on the website (page 10).

Optimum Panel Settings for the Current Style (One Touch Setting)

One Touch Setting is a powerful and convenient feature that automatically calls up the most appropriate panel settings (Voices, effects, etc.) for the currently selected Style, with the touch of a single button. If you've already decided which Style you wish to use, you can have One Touch Setting automatically select the appropriate Voice for you.

1 Select the Desired Style (steps 1–2 on page 44).

2 Press one of the ONE TOUCH SETTING [1]–[4] buttons.

Not only does this instantly call up all the settings (Voices, effects, etc.) that match and are most commonly used with the current Style, it also automatically turns on ACMP and SYNC START, so that you can immediately start playing the Style.

Confirming the One Touch Setting Contents

In the Style Selection display, touch  (Menu) then [Style Information] to call up the Information window that shows what Voices are assigned to the ONE TOUCH SETTING [1]–[4] buttons for the current Style. You can call up the desired settings also by touching one of the One Touch Settings numbers 1–4 directly on the Information window.

3 As soon as you play a chord with your left hand, the selected Style starts.

Each Style has four One Touch Setting setups. Press any other of the ONE TOUCH SETTING [1]–[4] buttons to try out other setups.

NOTE

For information on panel settings that are called up by One Touch Setting, refer to the OTS section of "Parameter Chart" in the Data List on the website (page 10).

NOTE

You can automatically have the One Touch Settings change when you select a Main section (A–D) of the selected Style. For details, refer to "OTS LINK" (page 65).

Setting up Keyboard Parts

There are four keyboard parts for your manual performance: LEFT, RIGHT 1, RIGHT 2 and RIGHT 3, and each part has one Voice. You can combine these parts by using the PART ON/OFF buttons to create luscious instrument textures and convenient performance combinations.

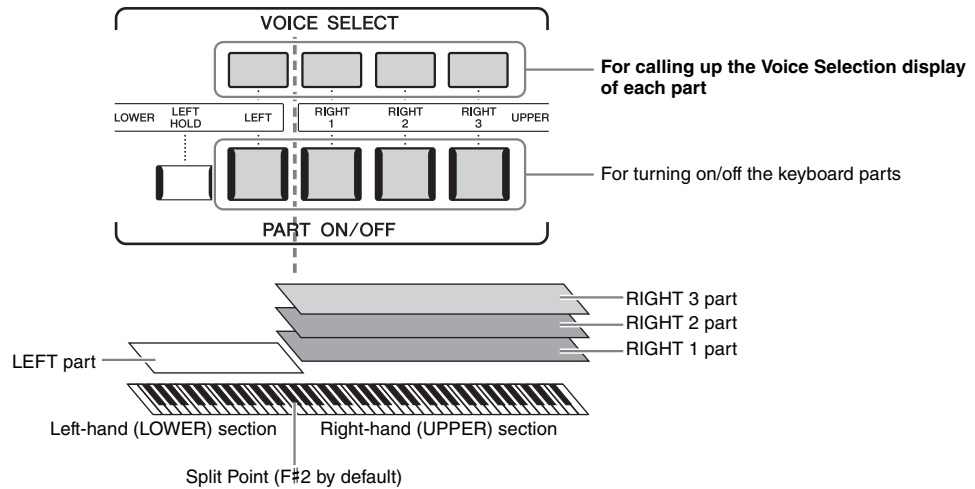

Creating combinations of keyboard parts (Layer, Split)

- **To play one single Voice over the entire keyboard:**

Turn on the RIGHT 1, 2 or 3 part. Make sure the LEFT part is turned off.

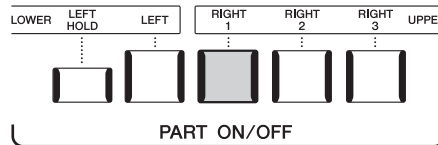

- **To play two or three different Voices simultaneously (Layer):**

Turn on two or more parts from RIGHT 1, 2 and 3.

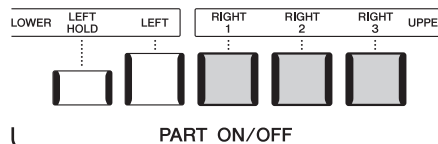

- **To play different Voices in the right- and left-hand sections of the keyboard (Split):**

Turn on the LEFT part and at least one of the RIGHT 1–3 parts. The F#2 and lower keys are used for the LEFT part while the upper keys (excluding F#2) are used for the RIGHT 1, 2 and 3 parts. The key which divides the keyboard into the left-hand and right-hand sections is referred to as the “Split Point.”

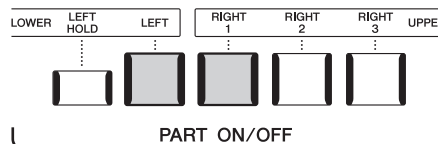

Turning each keyboard part on/off from the display

You can also turn parts on/off via the Home display, or the Voice Part Setup display. For details, see “Home Display” (page 30), or “Voice Part Setup Display” (Reference Manual on the web site).

Holding the LEFT part Voice (Left Hold)

By turning on the PART ON/OFF [LEFT HOLD] button when the LEFT part is ON, the LEFT part Voice is held even when the keys are released.

Non-decaying Voices such as strings are held continuously, while decay-type Voices such as piano decay more slowly (as if the sustain pedal has been pressed). This function is convenient when used along with Style playback since the sound of the chords matching Style playback are maintained.

To stop the LEFT part Voice which is sounding, stop Style or Song playback, or turn the [LEFT HOLD] button off.

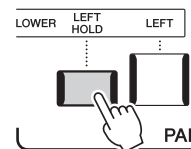

Setting the Split Point

The key which divides the keyboard into two areas is referred to as “Split Point.” There are three types of Split Point: Split Point (Style), Split Point (Left), and Split Point (Right 3). You can set them individually (as shown).

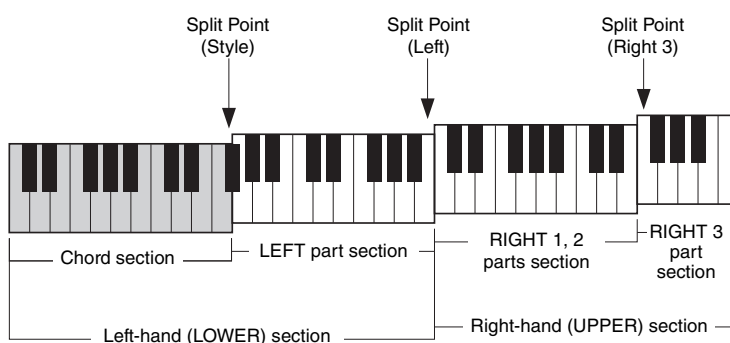

- **Split Point (Style):** Divides the left-hand (LOWER) section into the Chord section and the LEFT part section.
- **Split Point (Left):** Divides the keyboard into the left-hand (LOWER) section and the right-hand (UPPER) section.
- **Split Point (Right 3):** Divides the right-hand (UPPER) section into the RIGHT 1, 2 parts section and the RIGHT 3 part section.

1 Call up the Split Point/Fingering window.

[MENU] → [Split & Fingering]

2 Set the Split Point.

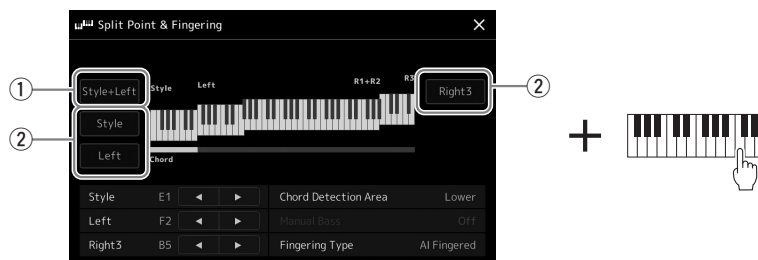

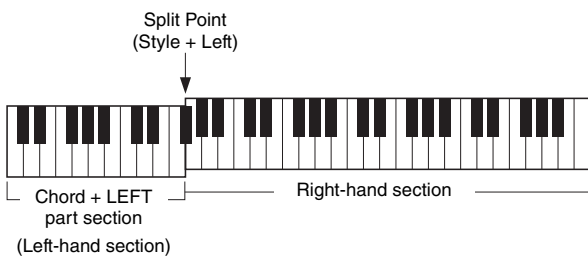
| | | |
|---|------------------------------------|---|
| ① | Split Point (Style + Left) | <p>Sets Split Point (Style) and Split Point (Left) to the same note. In this case, the Chord Section and the LEFT part section occupy the same area.</p> <p>Specify the Split Point directly from the keyboard by simultaneously holding [Style + Left] on the display and pressing the desired key on the keyboard.</p>  |
| ② | Split Point (Style, Left, Right 3) | <p>Sets each Split Point individually.</p> <p>Specify the Split Point directly from the keyboard by simultaneously holding the corresponding item on the display and pressing the desired key on the keyboard.</p> |

You can also specify each Split Point by note name, touching the [◀]/[▶] controls. Split Point (Style) is indicated by “Style,” Split Point (Left) is indicated by “Left,” and Split Point (Right 3) is indicated by “Right 3.”

 **NOTE**

Once you have touched [◀]/[▶], the Split Point type you are controlling is focused (corresponding indicator is colored). In this condition, you can change the value of the focused Split Point type by rotating the Data dial.

 **NOTE**

Split Point (Left) cannot be set lower than Split Point (Style), and Split Point (Right 3) cannot be set lower than Split Point (Left).

Specifying chords with your right hand for Style playback

By changing the Chord Detection area from the left-hand section to the right-hand section, you can play a bass line with your left hand while using your right hand to play chords for controlling Style playback.

- 1** Call up the Split Point/Fingering window.
[MENU] → [Split & Fingering]
- 2** Make the necessary settings by touching the display.

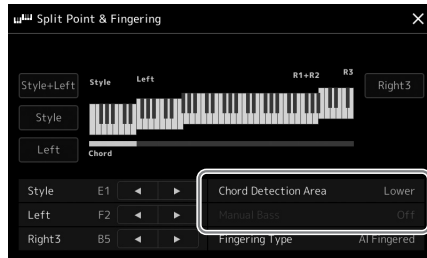

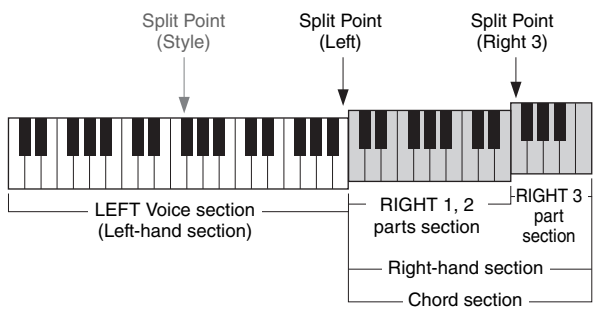
| | |
|-----------------------------|---|
| <p>Chord Detection Area</p> | <p>Select “Upper.” The Chord section is set to the right of the left Split Point. Fingering type is set to “Fingered*” automatically.</p>  <p>NOTE</p> <ul style="list-style-type: none"> • “Fingered*” is basically same as “Fingered,” except that “1+5,” “1+8” and Chord Cancel are not available. • For information about when the “Chord Detection Area” is set to “Lower,” refer to “Setting the Split Point” (page 49). • This parameter is set to “Lower” automatically when the Ensemble Voice is selected. |
| <p>Manual Bass</p> | <p>When this is set to “On”, the bass part of the current Style is muted and the Voice of the muted bass part is assigned to the left part.</p> <p>NOTE</p> <ul style="list-style-type: none"> • Manual Bass is set to “On” automatically by the default settings when you select “Upper” in the Chord Detection Area above. • This parameter is available only when the “Chord Detection Area” is set to “Upper.” |

Selecting a Voice for Each Keyboard Part

1 Press the VOICE SELECT button corresponding to the desired part.

The Voice Selection display (for the desired part) appears.

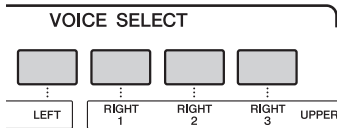



NOTE

You can also call up the Voice Selection display via the Home display (page 30) or the Voice Part Setup display (Reference Manual on the web site).

2 Touch the desired Voice.

To hear the characteristics of the Voices:

Touch  (Demo) to start demo playback of the selected Voice. Touch  (Demo) again to stop playback.

NOTE

• For basic operations of the Voice Selection display, refer to "File Selection Display" (page 32).

3 If necessary, try out the selected Voice.

Make sure that the desired keyboard part is turned on, and play the keyboard.

Voice Characteristics

The Voice type and its defining characteristics are indicated above the Voice name. There are various Voice characteristics; however, only the following ones are covered here. For detailed explanations, refer to the Reference Manual on the website (page 10).

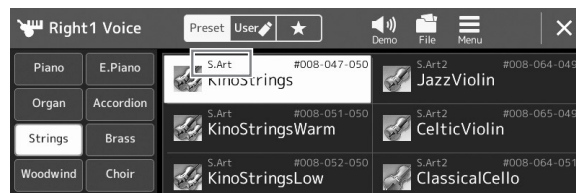

- **S.Art, S.Art2 (Super Articulation) Voices (page 67)**

Lets you create subtle, very realistic expressive nuances, simply by how you play, and by pressing a single button to add nuances.

- **Organ Flutes Voices (page 53)**

Lets you recreate all of the classic organ sounds by adjusting the flute footage levels and the percussive sounds, just like on conventional organs.

- **Revo Drum, Revo SFX Voices**

The Drum and SFX Voices let you play various drums and percussion instruments or SFX (sound effects) sounds on the keyboard. Especially, Revo Drum Voices recreate the natural sound of drums, even when playing the same key multiple times. Details are given in the Drum/Key Assignment List of the separate Data List.

Creating Original Organ Flutes Voices

Genos uses advanced digital technology to recreate the legendary sound of vintage organs. Just as on a traditional electronic organ, you can create your own sound by increasing and decreasing the levels of the flute footages. The created Voice can be saved for future recall.

NOTE

The term “footage” is a reference to the sound generation of traditional pipe organs, in which the sound is produced by pipes of different lengths (in feet).

1 On the Voice Selection display, select the desired Organ Flutes Voice.

Touch the [Organ] in the sub categories, then select the desired Organ Flutes Voice.

2 Return to the Home display, then touch  (Organ Flutes) located at the lower right of the Voice name to call up the Organ Flutes Voice Edit display.

3 Slide the Footage levers to adjust the footage settings.

The footage settings determine the basic sound of the Organ Flutes.

NOTE

- The available parameters differ depending on the Organ type.
- You can also make Effects and EQ settings. For details, refer to the Reference Manual on the website (page 10).

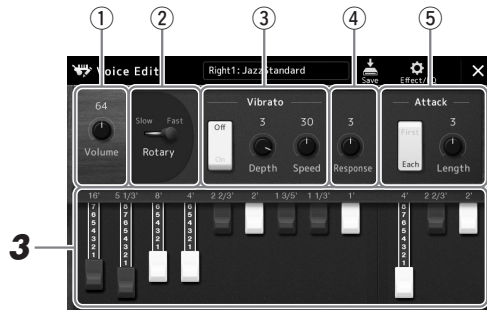

You can also change other settings here, such as Rotary Speaker and Vibrato.

| | | |
|---|----------------|--|
| ① | Volume | Determines the volume of the entire Organ Flutes sound. |
| ② | Rotary Speaker | Alternately switches between the slow and fast rotary speaker speeds. This parameter is available only when an effect which contains “Rotary” or “Rot” in its name is applied. |
| ③ | Vibrato | Turns the vibrato on or off, and allows you to adjust the vibrato depth and vibrato speed. |
| ④ | Response | Adjusts the response speed of both the Attack and Release portions of the sound. |
| ⑤ | Attack | Switches between two different Attack modes: First and Each, and determines the length of the Attack sound. |

4 Touch  (Save) and save the created Organ Voice.

For instructions on saving, refer to “File Management” (page 37).

NOTICE

The settings will be lost if you select another Voice or turn the power to the instrument off without executing the Save operation.

Using Ensemble Voices

These are special settings of the keyboard parts that feature multiple Voices, used in realistic ensemble combinations, such as brass section and string quartet. Up to four special parts or instruments are provided within a single Voice. But rather than just being a combination, the parts are dynamically assigned to the notes, and are distributed among the intervals you play in exceptionally natural, musical ways—as if four different players were actually playing the parts live. Moreover, the discrepancy between each instrument—the pitch, timing, etc.—can be controlled and “humanized,” making the overall sound amazingly authentic and expressive.

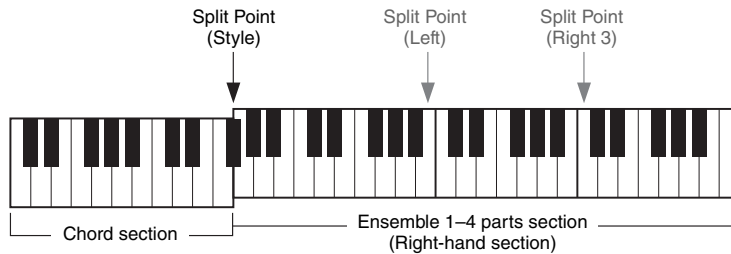

In this mode, the Keyboard parts (L, R1, R2 and R3) are changed into special Ensemble Parts 1-4 respectively. Since all the Ensemble Parts are handled as Right parts, the Left hand part is not available in this mode, although the Auto Accompaniment can be turned on and Styles can be played with the left hand.

Entering the Ensemble Voice mode

NOTICE

Entering the Ensemble Voice mode erases any Voice combination settings (L, R1, R2 and R3) you have made. Important panel settings should be memorized to Registration Memory (page 92).

- 1 Press any one of the VOICE SELECT buttons to call up the Voice Selection display.

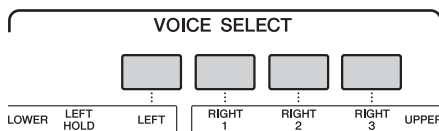

- 2 Touch [Ensemble] to enter the Ensemble Voice mode.



- 3 Touch to select the desired Ensemble Voice preset.
- 4 Play the keyboard.

NOTE

You can edit settings, such as changing each of the Voices that make up the Ensemble Voice and change how the Voices are assigned the notes of the chords you play. For details, refer to the Reference Manual on the website.

To return to the Home display

Press the [EXIT] button or the [HOME] button. The Voice area shows the Ensemble Voice name. To call up the Voice Selection display again to select other presets, touch the Voice area of the Home display.

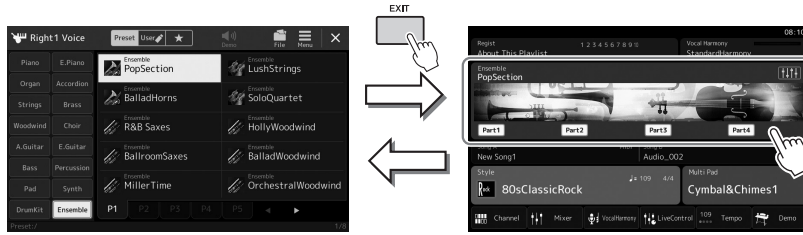

Exiting from the Ensemble Voice mode

- 1 Press any one of the VOICE SELECT buttons to call up the Voice Selection display.

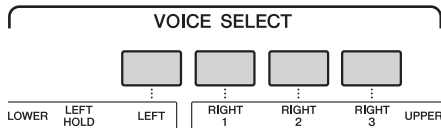

- 2 Select a Voice other than an Ensemble Voice.

After you've selected another Voice, you can confirm that the Ensemble Voice mode is no longer active. To do this, press the [Home] button to return to the Home display and check that the Voice area shows four different Voice names.

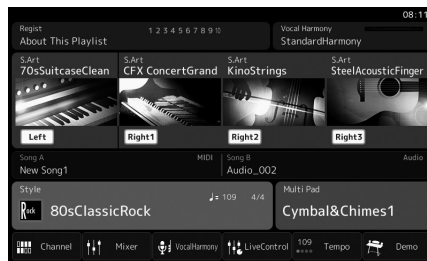

Setting up Keyboard Harmony/Arpeggio

You can apply the Keyboard Harmony or Arpeggio features to enhance or change the sound of the Right-hand parts (RIGHT 1–3). Keyboard Harmony applies performance effects such as harmony (duet, trio, etc.), echo, tremolo and trill to the notes played in the Right-hand section. The Arpeggio function lets you play arpeggios (broken chords) by simply pressing the notes of the chord. For example, you could play the notes C, E and G to trigger interesting and rhythmically dynamic phrases. This feature can be used for music production as well as live performance.

NOTE

When you select another Voice for the RIGHT 1 part, the Keyboard Harmony/Arpeggio type is automatically set to the type which is memorized as the Voice Set. For details on the Voice Set function, refer to the Reference Manual on the website.

Using Keyboard Harmony

1 Call up the operation display.

[MENU] → [Kbd Harmony/Arp]

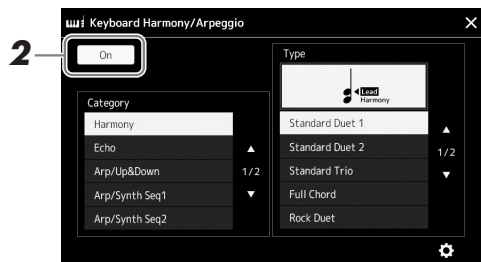

2 Set the Keyboard Harmony/Arpeggio function to “On.”

When this is set to “On,” Keyboard Harmony is applied to your keyboard performance automatically.

3 Touch to select the category “Harmony” or “Echo.”

4 Touch the desired Harmony or Echo type.

Touching  (detailed settings) calls up the detailed settings popup window. For more information, refer to the Reference Manual on the web site.

5 Play the keyboard.

The effect selected in step 4 is applied to the right-hand melody.

NOTE

You can also set the function to “On” by turning the [HARMONY/ARPEGGIO] button on.



To turn off the effect, turn the [HARMONY/ARPEGGIO] button off.

■ Keyboard Harmony category types (Harmony/Echo)

● Harmony Category

Standard Duet—Strum

These types apply the harmony effect to notes played in the right-hand section of the keyboard according to the chord specified in the left-hand section of the keyboard. (Note that the “1+5” and “Octave” settings are not affected by the chord.)

- When the [ACMP] button is on and the LEFT part is off:

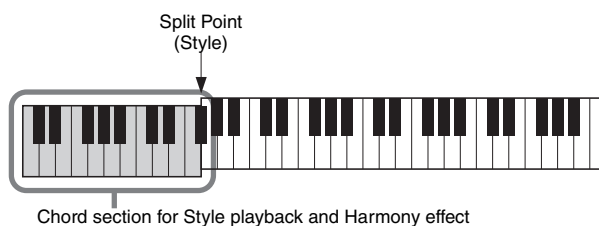

NOTE

For details on the Split Point, refer to page 49.

- When the [ACMP] button is off and the LEFT part is on:

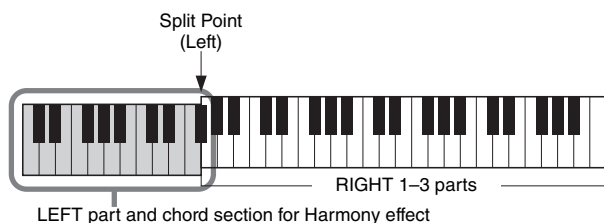

- When both the [ACMP] button and the LEFT part are on:

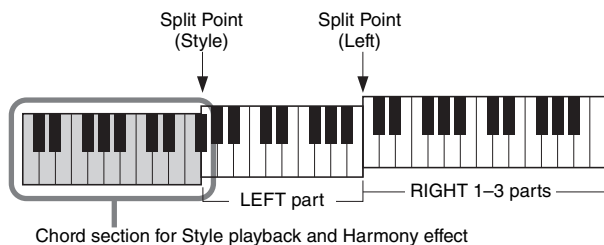

Multi Assign

The Multi Assign effect automatically assigns the notes of chords you play on the right-hand section of the keyboard to separate parts (Voices). For example, if you play a three-note chord, the first note you press is played by the RIGHT 1 Voice, the second by the RIGHT 2 Voice, and the third by the RIGHT 3 Voice. The Multi Assign effect is not affected by the [ACMP] and LEFT part on/off status.

● Echo Category (Echo, Tremolo, Trill)

The Echo, Tremolo or Trill effect is applied to the note played in the right-hand section of the keyboard in time with the currently set tempo, regardless of the [ACMP] and the LEFT part on/off status. Keep in mind that Trill works only when you hold down two notes on the keyboard simultaneously (or the last two notes, if more than two notes are held), and it plays those notes alternately.

Using Arpeggio

1 Call up the operation display.

[MENU] → [Kbd Harmony/Arp]

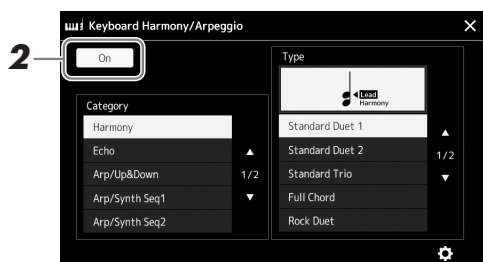

2 Set the Keyboard Harmony/Arpeggio function to “On.”

When this is set to “On,” Keyboard Harmony is applied to your keyboard performance automatically.

3 Touch to select a category other than “Harmony” or “Echo.”

4 Touch the desired Arpeggio type.

Touching  (detailed settings) calls up the detailed settings popup window. For more information, refer to reference manual on the web site.

NOTE

You can also set the function to “On” by turning the [HARMONY/ARPEGGIO] button on.



5 Play a note or notes to trigger the Arpeggio.

The arpeggiated phrase differs depending on the notes played.

To turn off the effect, turn the [HARMONY/ARPEGGIO] button off.

NOTE

- By using the Arpeggio Quantize function, Arpeggio playback can be synchronized with Song/Style playback, allowing any slight imperfections in the timing to be corrected. This can be set in the display: [MENU] → [VoiceSetting] → [S.Art2/Arpeggio].
- Arpeggio playback can be continued even after the note has been released, by assigning the Arpeggio Hold function to the footswitch. For instructions, refer to page 63.

Setting up Multi Pads

Selecting Multi Pads

- 1 Press the MULTI PAD CONTROL [SELECT] button to call up the Multi Pad Bank Selection display.

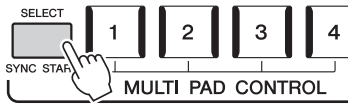

NOTE

You can also call up the Multi Pad Selection display via the Home display (page 30).

- 2 Touch the desired Multi Pad Bank.

- 3 If necessary, try out the selected Multi Pad(s).

Simply press the MULTI PAD CONTROL [1]–[4] buttons to start playback of the corresponding phrase. To stop playback, press the [STOP] button.

For more information on Multi Pad playback control, refer to “Controlling Multi Pad Playback” (page 70).

NOTE

For basic operations of the Multi Pad Selection display, refer to “File Selection Display” (page 32).

Creating and Editing Multi Pads

You can create your original Multi Pads in one of three ways:

- Recording new phrases
- Editing existing Multi Pad phrases
- Linking with audio files (Audio Link Multi Pad)

Also, you can make your original Multi Pad Bank by managing each Multi Pad. For details, refer to the Reference Manual on the web site (page 10).

Memorizing Original Panel Settings to One Touch Setting

You can memorize your original panel settings (mainly Style, Voices, and Multi Pads) to a One Touch Setting (OTS). The newly created One Touch Setting will be saved in the User drive or a USB flash drive as a Style, and you can call up the One Touch Setting as a part of the Style.

NOTE

For information on which panel settings are memorized to One Touch Setting, refer to "Parameter Chart" in the Data List on the website (page 10).

- 1** Select the desired Style to memorize your One Touch Setting.
- 2** Make the desired panel settings, such as those for Voices and Effects.
- 3** Press the [MEMORY] button in the REGISTRATION MEMORY section.

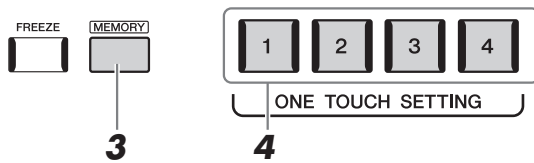

A message appears. However, you do not need to make any settings here, since the On/Off settings in this display do not affect the One Touch Setting function.

- 4** Press the desired ONE TOUCH SETTING [1]–[4] button to which you wish to memorize your panel settings.

A message appears prompting you to save the panel settings at this time. To go on and memorize various panel settings to other buttons, touch [No], then repeat steps 2–4 as necessary, finally saving all your new settings in Step 5 below.

NOTE

For OTS buttons to which your panel settings have not been memorized, the OTS settings of the original Style will be maintained.

- 5** Touch [Yes] to call up the Style Selection display for saving your data, then save the current settings as a User Style.

For instructions on saving, refer to "File Management" (page 37).

NOTICE

The memorized One Touch Setting will be lost if you change the Style or turn the power off without carrying out the Save operation.

Changing the Pitch of the Keyboard

Transposing the pitch in semitones (TRANPOSE [-]/[+] buttons)

The TRANPOSE [-]/[+] buttons transpose the overall pitch of the instrument (the keyboard sound, Style playback, MIDI Song playback, and so on) in semitone steps (from -12 to 12). To instantly reset the transpose value to 0, press the [-] and [+] buttons simultaneously.

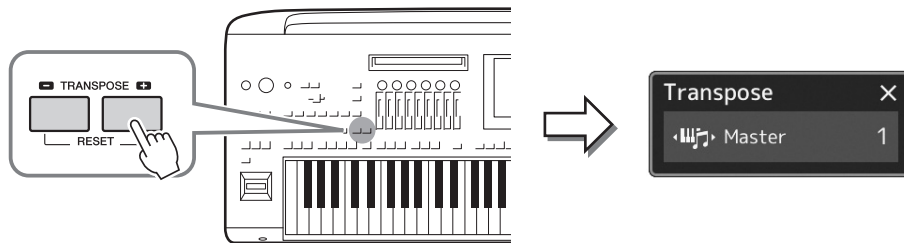

NOTE

- If you want to transpose the pitch of the Audio Song, use the Pitch Shift parameter on page 80.
- The Transpose functions do not affect the Drum Kit or SFX Kit Voices.

You can independently select the part to be transposed as desired. Touch the Transpose pop-up several times until the desired part appears, then use the TRANPOSE [-]/[+] buttons to transpose it.

NOTE

Transpose can be done on the display also via [MENU] → [Transpose]. For details, refer to the Reference Manual on the website.

| | |
|----------|---|
| Master | Transposes the pitch of the entire sound, with the exception of the Audio Song and input sound from a microphone or the AUX IN jacks. |
| Keyboard | Transposing the keyboard pitch including the chord root for triggering Style Playback. |
| Song | Transposes the pitch of the MIDI Song. |

Fine Tuning the Pitch

By default, the pitch of the entire instrument is set to 440.0 Hz according to equal temperament. This setup can be changed from the display called up via [MENU] → [Tuning]. For details, refer to the Reference Manual on the website.

Transposing the pitch in octave (UPPER OCTAVE [-]/[+] buttons)

The UPPER OCTAVE [-]/[+] buttons allow you to shift the pitch of the Right 1–3 parts up or down by one octave. To instantly reset the octave value to 0, press the [-] and [+] buttons simultaneously.

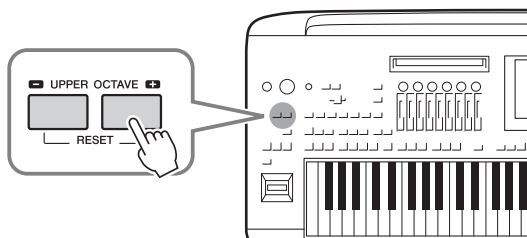

Setting up Assignable Controllers

You can assign parameters and functions to the LIVE CONTROL knobs/sliders, the [ROTARY SP/ASSIGNABLE] button, or optional footswitches for quick operations and expressive control during your keyboard performance. The setup of assignable controllers is stored/recalled from the registration memory so you can change them all together.

Selecting the Assign Types of the LIVE CONTROL knobs/sliders

Each setup of assigned parameters for knobs is called “Knob Assign Type” and for sliders, it is called “Slider Assign Type.” There are three Knob Assign Types (1–3) and they can be switched in sequence by pressing the [KNOB ASSIGN] button. There are normally three Slider Assign Types (Balance and Assign Types 1 and 2), and they can be switched in sequence by pressing the [SLIDER ASSIGN] button. The selected Assign Types for knobs and sliders will be reset when the power is turned off.

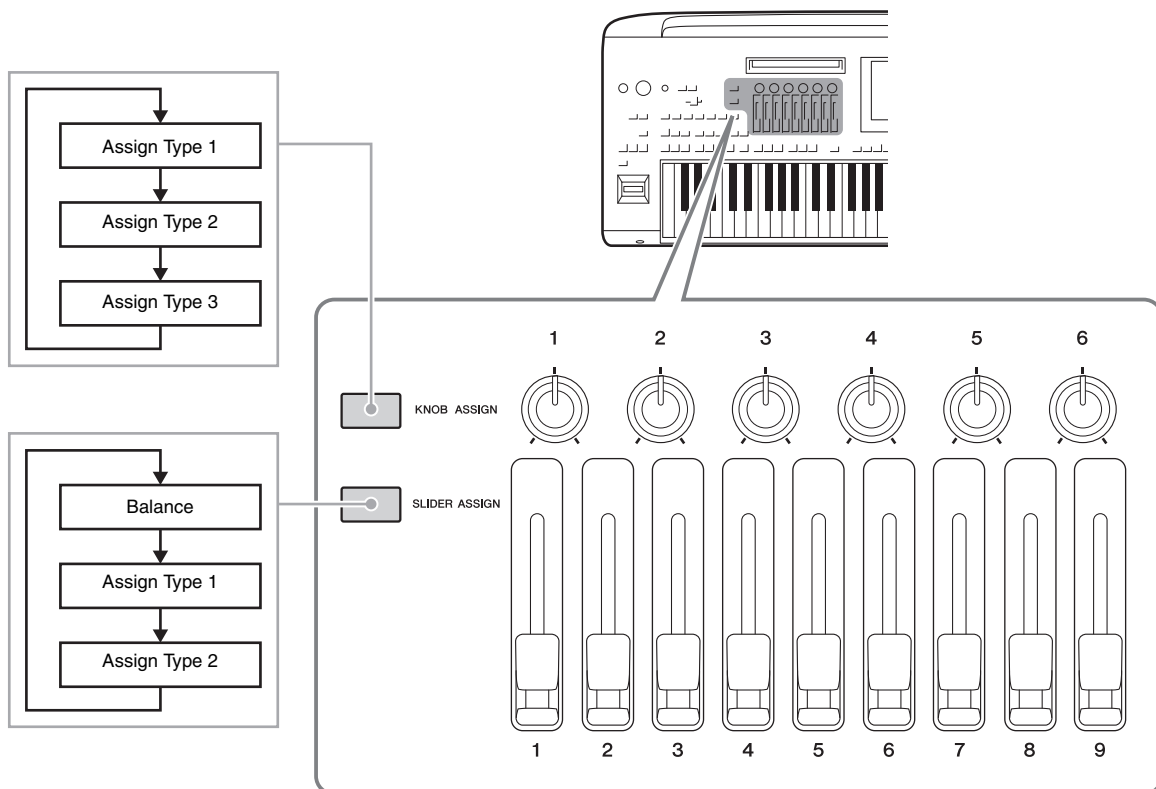

Editing the Assign Type of the knobs/sliders

Knob Assign Types 1–3 and Slider Assign Types 1–2 can be edited in the Edit display which is called up as follows: [MENU] → [Live Control]. For details of editable items, refer to the Reference Manual on the website.

NOTE

When Organ Flutes Voice is selected for each Keyboard Part, additional Slider Assign Types can be specially selected for operating footage levers corresponding to each Part, letting you adjust the sound with much the same feel as on an actual instrument.

Assigning functions to the [ROTARY SP/ASSIGNABLE] button

Various functions can be assigned to the [ROTARY SP/ASSIGNABLE] button.

- 1 To call up the Edit display, touch [MENU] → [Assignable].**

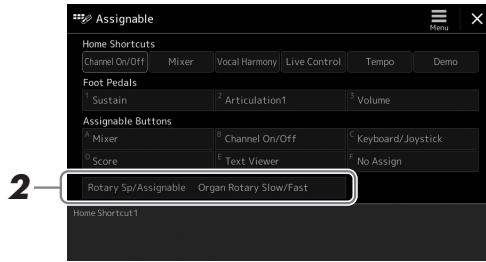

- 2 Double-tap (touch twice) the “Rotary Sp/Assignable” item on the display.**

The function selection pop-up window appears.

- 3 Touch the desired function.**

 **NOTE**

For details on assignable parameters and functions, refer to the Reference Manual on the website.

Assigning functions to footswitches/foot controllers

You can assign various functions to optional footswitches/foot controllers.

- 1 To call up the Edit display, touch [MENU] → [Assignable].**

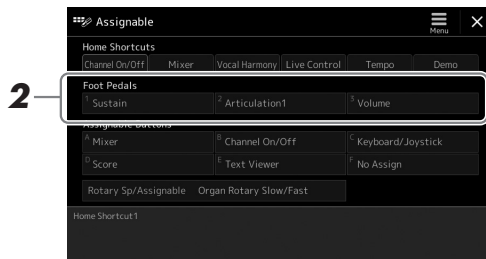

- 2 Double-tap (touch twice) the desired item in the “Foot Pedals” area (shown above).**

The function selection pop-up window appears.

- 3 Touch the desired function.**

 **NOTE**

- For details on assignable parameters and functions, refer to the Reference Manual on the website.
- For connecting footswitches/foot controllers, refer to “Connecting Footswitches/Foot Controllers” (page 110).

Playing with Styles—Operations While Performing

If you've made all desired settings for a single song (in the previous sections), now you're ready to play the keyboard. This section mainly explains the various Style-related operations you'll use during your keyboard performance: Style playback, applying expressive effects, and Multi Pad playback.

Operating Style Playback

Starting and stopping Style playback

- **[START/STOP] button**

Starts playback of the rhythm part of the current Style. To stop playback, press the button again.



Playing back both rhythm and auto accompaniment (ACMP)

If the [ACMP] button is turned on, both the rhythm part and auto accompaniment can be played back when playing chords in the chord section during Style playback.



- **[SYNC START] button**

This puts the Style playback in "standby." The Style starts playing back when you press any note on the keyboard (when [ACMP] is off) or you play a chord with your left hand (when [ACMP] is on). While a Style is playing back, pressing this button stops the Style and puts playback in standby.



- **[SYNC STOP] button**

You can start and stop the Style any time you want by simply playing or releasing the keys in the chord section of the keyboard. Make sure that the [ACMP] button is on, press the [SYNC STOP] button, then play the keyboard.



NOTE

When the Fingering type (page 46) is set to "Full Keyboard" or "All Full Keyboard," Sync Stop cannot be turned on.

- **INTRO [I]–[III] buttons**

Genos features three different Intro sections that let you add an introduction before starting the Style playback. After pressing one of the INTRO [I]–[III] buttons, start playback of the Style. When the Intro finishes playing, the Style playback automatically shifts to the Main section.



- **ENDING/rit. [I]–[III] buttons**

Genos features three different Ending sections that let you add an ending before stopping Style playback. When you press one of the Ending [I]–[III] buttons while Style is playing back, the Style will automatically stop after the ending is played. You can have the ending gradually slow down (ritardando) by pressing the same ENDING button once again, while the ending is playing.



Fading In/Out

The Fade In/Out function produces smooth fade-ins and fade-outs when starting/stopping the playback of a Style or Song. You can assign this function to the [ROTARY SP./ASSIGNABLE] button, footswitches, or the ASSIGNABLE [A]–[F] buttons.

NOTE

For information on assigning functions to each controller, refer to “Setting up Assignable Controllers” (page 62) and “Setting the Functions or Shortcuts to the ASSIGNABLE Buttons” (page 100).

- **To start playback with a fade in:**
When playback is stopped, press the button to which this function has been assigned. Then press the [START/STOP] button for Style (or the [PLAY/PAUSE] button for MIDI Song).
- **To stop playback with a fade out:**
During playback, press the button to which this function has been assigned.

Changing pattern variations (Sections) during Style playback

Each Style features four different Main sections, four Fill-in sections and a Break section. By using these sections effectively, you can easily make your performance sound more dynamic and professional. The section can be freely changed while the Style is playing back.

● MAIN VARIATION [A]–[D] buttons

Press one of the MAIN VARIATION [A]–[D] buttons to select the desired Main section (the button lights in red). Each is an accompaniment pattern of a few measures or more and it plays indefinitely. Pressing the selected MAIN VARIATION button again plays an appropriate fill-in pattern to spice up the rhythm and break the repetition. After the fill-in finishes playing, it leads smoothly into the Main section.

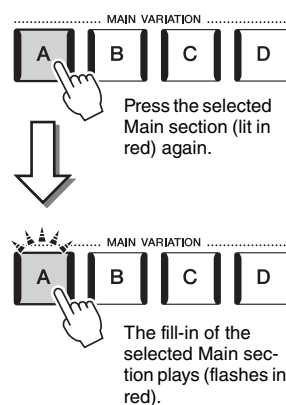

AUTO FILL IN function

When the [AUTO FILL IN] button is turned on, pressing any of the MAIN VARIATION [A]–[D] buttons as you play automatically plays a fill-in section for a smooth, dynamic transition into the next (or same) section.

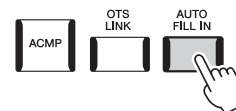

Automatically changing One Touch Settings with the Main sections (OTS LINK)

The convenient OTS (One Touch Setting) Link function lets you automatically have One Touch Settings change when you select a different Main section (A–D). The Main sections A, B, C and D correspond to One Touch Settings 1, 2, 3 and 4 respectively. To use the OTS Link function, turn the [OTS LINK] button on.

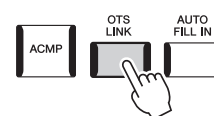

NOTE

You can change the timing in which the One Touch Settings change with the MAIN VARIATION [A]–[D] changes. To do this, call up the display via [MENU] → [Style Setting] → [Setting], then set the OTS Link Timing parameter. For details, refer to the Reference Manual on the website (page 10)

● [BREAK] button

This lets you add dynamic breaks in the rhythm of the accompaniment. Press the [BREAK] button during Style playback. When the one-measure Break pattern finishes playing, Style playback automatically shifts to the Main section.



About the lamp status of the section buttons (INTRO/MAIN VARIATION/BREAK/ENDING)

- **Red:** The section is currently selected.
- **Red (flashing):** The section will be played next, following the currently selected section.
 - * The MAIN VARIATION [A]–[D] button lamps also flash in red when the fill-in is playing.
- **Blue:** The section contains data but is not currently selected.
- **Off:** The section contains no data and cannot be played.

Expressively Controlling Your Performance

Using the Joystick

By moving the joystick in a horizontal (X) or vertical (Y) direction, you can bend the notes up or down, or apply modulation effects. Move the joystick to control the sound while playing the keyboard.

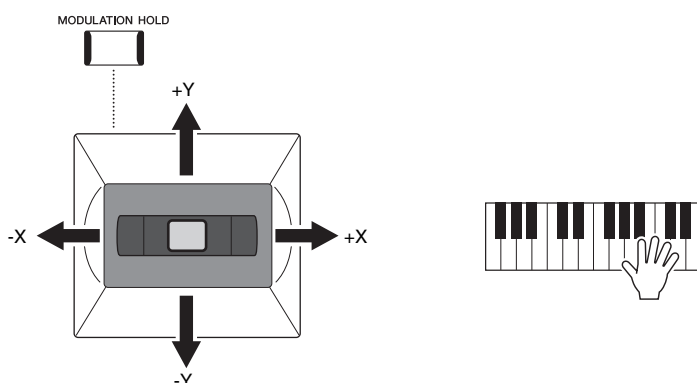

● X: Pitch Bend

Bends notes up (by moving the joystick to the right) or down (by moving the joystick to the left) while playing the keyboard. This is applied to all keyboard parts (RIGHT 1–3 and LEFT).

NOTE

- The maximum pitch bend range can be changed on the display called up via [MENU] → [Keyboard/Joystick] → [Joystick].
- The Pitch Bend effect may not be applied to the LEFT part during Style playback, depending on the Style setting.

● Y: Modulation

The Modulation function applies a vibrato effect to notes played on the keyboard. By default, this is applied to the keyboard parts RIGHT 1–3. You can set whether the modulation effects produced by the joystick will be applied or not to each keyboard part independently: [MENU] → [Keyboard/Joystick] → [Joystick] → Modulation (+), Modulation (-).

NOTE

The Modulation effects may not be applied to the LEFT part during Style playback, depending on the Style setting.

Holding the Modulation value (MODULATION HOLD)

The Joystick is self-centering when released. However, you can hold the current Modulation value by pressing the [MODULATION HOLD] button.

- If the [MODULATION HOLD] button is turned on while the Joystick is moved, the Modulation value (Y-axis value) is fixed and held even after the Joystick is released.
- If the [MODULATION HOLD] button is turned off, the Modulation value returns to the default value for the Voice of each Part. (The position of the Joystick at that time is ignored.)

NOTE

When the Voice of one of the keyboard parts is set, the [MODULATION HOLD] button will be turned off automatically, and then the Modulation (+) and Modulation (-) parameters will be reset.

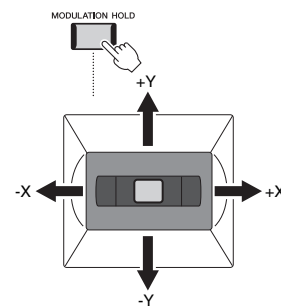

Applying sustain to the RIGHT 1–3 Voices

The [SUSTAIN] button turns the Sustain function on and off. When on, all notes played on the keyboard with the right-hand parts (RIGHT 1, 2, 3) have a longer sustain.

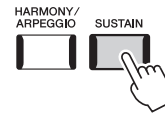

Playing and Controlling Super Articulation Voices

The Super Articulation Voices (S.Art Voices and S.Art2 Voices) enable you to create subtle, very realistic expressive nuances, simply by how you play. The Voice type (S.Art, S.Art2) is indicated above the name of Super Articulation Voices, on the Voice Selection display. Moreover, with the [ART. 1]/[ART. 2]/[ART. 3] buttons in this instrument, you can add those expressive nuances by simply pressing a single button.

NOTE

The applied articulation effect differs depending on the selected Voice. For details, refer to the Data List on the website.

Automatic articulation effects of Super Articulation Voices

■ S.Art Voices

The S.Art Voices provide many benefits with great playability and expressive real-time control.

Example: Saxophone Voice

If you play a C note and then an adjacent D in a very legato way, you will hear the note change seamlessly, as though a saxophone player played it in a single breath.

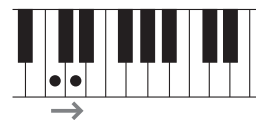

Example: Concert Guitar Voice

If you play a C note and then the E just above in a very legato but firm way, the pitch slides up from C to E.

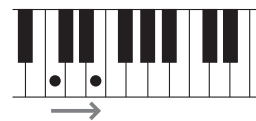

■ S.Art2 Voices

Some of the wind instrument and strings Voices feature a special technology called AEM, which utilizes detailed samples of special expressive techniques used on those specific instruments—to bend or slide into notes, to “join” different notes together, or to add expressive nuances at the end of a note, etc. You can add these articulations by playing legato or non-legato, or jumping between notes in octave intervals or greater.

NOTE

AEM (Articulation Element Modeling) is a technology that simulates the sound of acoustic instruments naturally by smoothly joining the most appropriate sound samples selected from the data base in real time during performance.

Example: Clarinet Voice

If you hold a C note and play the B \flat above, you’ll hear a glissando up to the B \flat . Some “note off” effects are also produced automatically when you hold a note for over a certain time.



NOTE

Each S.Art2 Voice has its own default vibrato setting, so that when you select a S.Art2 Voice, the appropriate vibrato is applied. You can adjust the vibrato by moving up or down the Joystick.

Adding articulation effects by the [ART. 1]–[ART. 3] buttons

When you select a Super Articulation Voice, the [ART. 1]/[ART. 2]/[ART. 3] buttons may light in blue. Pressing a lit button adds the effect (buttons not lit have no effect).



Below are three examples of Super Articulation Effects by the buttons.

■ Example 1

Pressing the available [ART] button triggers different playing effects and techniques, separate from your keyboard playing.

For example, pressing the [ART] button for a S.Art saxophone Voice can produce breath noise or key noise, while doing the same for a S.Art guitar Voice can produce fret noise or body-tapping sound. You can effectively intersperse these into the notes as you play.

While the articulation effect sounds, the button lights in red.

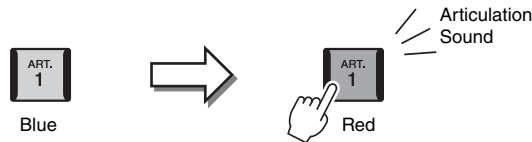

■ Example 2

Playing the keyboard while holding down the available [ART] button changes the nature of the Voice.

For example, in the case of the NylonGuitar Voice in A.GUITAR category, holding down the [ART. 1] button lets you play harmonics for the guitar Voice. Releasing the button returns the Voice to normal.

The button lights in red while it is being held down.



■ Example 3

When an S.Art2 Voice is selected, pressing the available [ART] button and playing/releasing a note enables you to add articulation effects, such as bend up/down, glissando up/down, brass fall, etc.

When you press the available [ART] button, it will flash in red until the effect is finished playing. You can cancel by pressing the button again while it flashes. Immediately after you press/release the note and articulation effect sounds, the button lights in red.

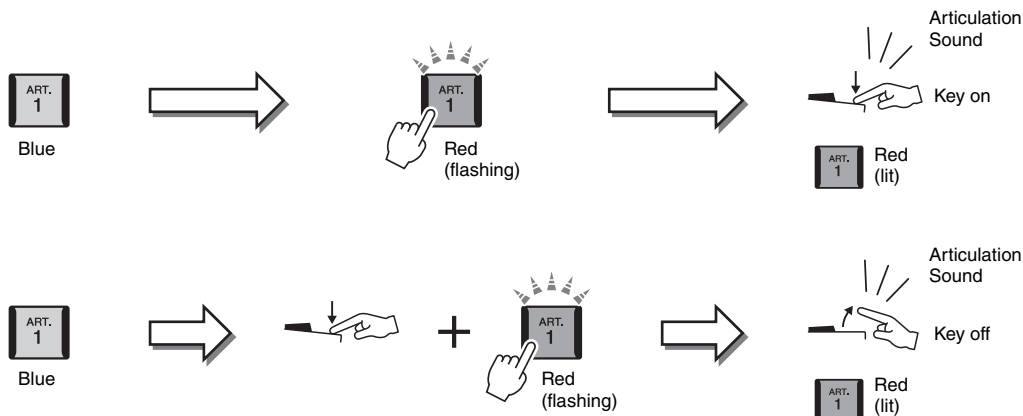

Example 3 effects can also be used in the same manner as Example 2. Holding an [ART] button (the button flashes in red) and playing/releasing a note enables you to add the articulation effect several times in succession.

 **NOTE**

Keeping with the realistic response of the original instruments, the effects applied vary depending on the keyboard range you are playing in.

When Super Articulation Voices are Selected for Multiple Parts

When you select S.Art/S.Art2 Voices for two or more keyboard parts, using an [ART] button simultaneously affects all parts for which S.Art/S.Art2 Voices are selected.

When an Example 3 effect is assigned to both the Right and Left parts and an [ART] button flashes in red (standby status), playing only one part (for example, the Right 1 part) adds an articulation effect to only that part. Since the other part (Left part) is kept in standby status, the button continues flashing. To cancel the standby status, you need to play the keyboard in the Left part range. (Pressing the flashing button does not cancel standby status in this case, because this can cancel the standby of the Left part, but turns the Right part to standby again.)

Controlling Multi Pad Playback

Playing the Multi Pads

1 Press any of the MULTI PAD CONTROL [1]–[4] buttons to play a Multi Pad phrase.

The corresponding phrase for the button starts playing back in its entirety at the currently set tempo. You can play up to four Multi Pads at the same time.

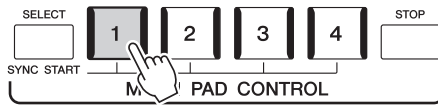

NOTE

- There are two types of Multi Pad data. Some types will play back once and stop when they reach to the end. Others will be played back repeatedly (loop).
- Pressing the pad during its playback will stop playing and begin playing from the top again.

2 Press the [STOP] button to stop playback of the Multi Pad(s).

If you want to stop a specific pad, simultaneously hold down the [STOP] button and press the pad(s) you wish to stop.

NOTE

- While the Style or MIDI Song is playing back, pressing the Multi Pad button starts playback at the top of the next measure. When the Style or MIDI Song is stopped, pressing the Multi Pad button starts playback immediately.
- While the Style or MIDI Song is playing back, pressing the STYLE CONTROL [START/STOP] or SONG A/B [PLAY/STOP] button also stops playback of the Multi Pad(s). While both the Style and MIDI Song is playing back, pressing the SONG A/B [PLAY/STOP] button stops playback of the Song, Style and Multi Pad(s). This behavior can be changed with settings on the Song Setting and Style Setting displays. For details, refer to the Reference Manual on the website.

About the lamp status of the MULTI PAD CONTROL [1]–[4] buttons

- **Blue:** Indicates that the corresponding pad contains data (phrase).
- **Red:** Indicates that the corresponding pad is playing back.
- **Red (flashing):** Indicates that the corresponding pad is in standby (Synchro Start; refer to page 71).
- **Off:** Indicates the corresponding pad contains no data and cannot be played.

Using Chord Match

When the [ACMP] or LEFT part is on, Multi Pad phrases automatically change the pitch to match the chord you play in the chord section.

Play the chord in the chord section before/after pressing any of the Multi Pads.

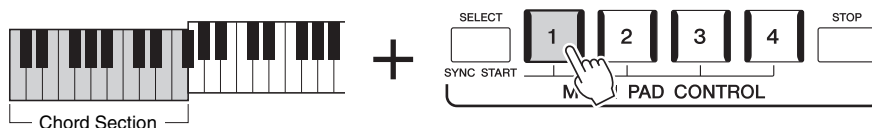

NOTE

Some Multi Pads are not affected by Chord Match.

Using the Multi Pad Synchro Start Function

You can also start Multi Pad playback by playing the keyboard or by starting Style playback.

1 While holding the MULTI PAD CONTROL [SELECT] button, press the desired button or buttons from [1]–[4].

The corresponding buttons flash in red, indicating standby status.

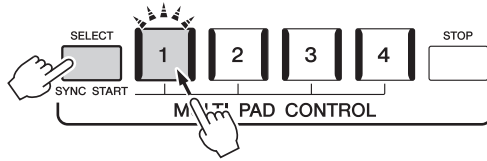

NOTE

To cancel the standby status of the selected Pad, carry out the same operation, or simply press the [STOP] button to cancel the status of all Pads.

2 Start playback of the Multi Pad.

- When [ACMP] is off, press any note, or play back a Style.
- When [ACMP] is on, play a chord in the chord section, or play back a Style.

If you enable standby for a Multi Pad during Style or Song playback, pressing any note (when [ACMP] is off) or playing a chord in the chord section (when [ACMP] is on) will start Multi Pad playback at the top of the next measure.

NOTE

When two or more Multi Pads are in standby status, pressing any one of them starts simultaneous playback of all of them.

This section explains how to set up for your singing performance with Songs, using Song selection and Vocal Harmony settings.

As is the case in Chapter 1, the settings made in this section can be collectively stored in the Registration Memory as one song setting (page 92).

Setting Up Song Playback

Songs—MIDI Song and Audio Song

For Genos, “Song” refers to MIDI or audio data which include preset songs, commercially available music files, etc. Not only can you playback a song and listen to it, but you can also play the keyboard or sing along with Song playback.

There are two kinds of Songs that can be recorded and played back on this instrument: MIDI Songs and Audio Songs.

● MIDI Song

A MIDI Song is comprised of your keyboard performance information and is not a recording of the actual sound itself. The performance information refers to which keys are played, at what timing, and at what strength—just as in a musical score. Based on the recorded performance information, the tone generator (of Genos, etc.) outputs the corresponding sound. Since MIDI Song data contains the information such as keyboard part and Voice, you can play more effectively by viewing the score, turning the particular part on or off, or changing Voices.

● Audio Song

An Audio Song is a recording of the performed sound itself. This data is recorded in the same way as that used in recording cassette tapes, or with voice recorders, etc. Audio Songs can be played back on portable music players and many other devices, making it easy for you to let others hear what you have played.

If you want to play back a Song in a USB flash drive, connect the USB flash drive containing Song data to the [USB TO DEVICE] terminal beforehand.

NOTE

Before using a USB flash drive, be sure to read “Connecting USB Devices” on page 111.

Song File Compatibility

You can play back the following types of Songs.

- Preset Songs (MIDI Songs)
- Your own recorded Songs (for instructions on recording, see page 90)
- Commercially available Songs: MIDI files in SMF (Standard MIDI File) format, Audio files in WAV or MP3 format.

WAV 44.1 kHz sample rate, 16 bit resolution, stereo

MP3 MPEG-1 Audio Layer-3: 44.1 kHz sample rate, 64–320 kbps bit rate, stereo

NOTE

- For a general overview of MIDI and how you can effectively use it, refer to “MIDI Basics” on the website (page 10).
- For information on compatible MIDI formats, refer to page 11.

Switching Song playback modes

Genos features two modes of Song playback: Dual Player mode and Song List mode. Dual Player mode plays back two Songs (SONG A and SONG B) simultaneously and lets you make a smooth, DJ-like transition between the two, using the special Cross Fader. Song List mode plays back Songs continuously along with a Song List previously made.

1 Press the [SONG] button to call up the Song Playback display.

Dual Player or Song List is displayed, depending on which you have selected last time.

2 Touch the display to switch the Song playback mode.

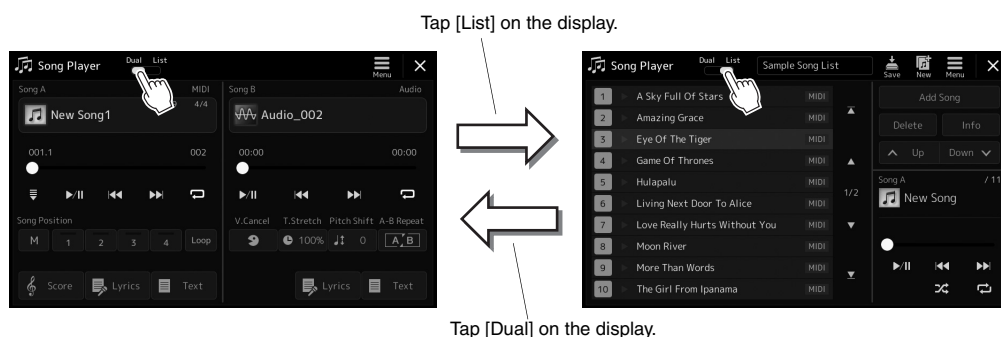

Selecting Songs (Dual Player mode)

- 1** Press the [SONG] button to call up the Song Playback display. Make sure that Dual Player mode is selected.

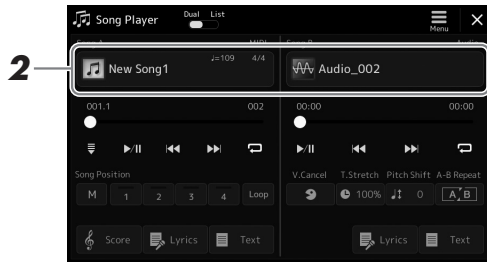

- 2** Touch the Song name in the Song A or Song B area.

The Song Selection display appears.

- 3** Select the desired Song for each, A and B.

For selecting from Audio Songs, touch [Audio].

For selecting from MIDI Songs, touch [MIDI].



Viewing Song information

When an Audio Song is selected on the Song Selection display, touching  (Menu) then [Audio Song Information] calls up the information window.

NOTE

- For basic operations of the Song Selection display, refer to “File Selection Display” (page 32).
- You can select two Audio Songs or one Audio Song and one MIDI Song for SONG A and SONG B. Two MIDI Songs cannot be selected.
- You can call up the display of Song playback related settings, via  (Menu) → [Song Setting].

For detailed playback operations and the crossfade function, refer to pages 78, 85.

Selecting Songs (Song List mode)

- 1** Press the [SONG] button to call up the Song Playback display. Make sure that Song List mode is selected.

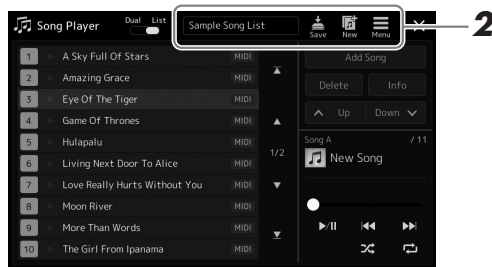

2 Prepare a Song List

● When creating a new Song List

Touching  (New) on the display allows you to create a new Song List.

For details on how to edit the Song List, refer to the Reference Manual on the website.

● When selecting an existing Song List

2-1 Call up the Song List File Selection display by touching the Song List name.

2-2 Touch the desired Song List file.

3 Touch the desired Song from the selected Song List.

The selected Song is highlighted.

For detailed playback controls, refer to page 78.

For information on controlling continuous playback of the Songs on the list, refer to the Reference Manual on the website.

Applying Effects to the Microphone Sound (Vocal Harmony)

You can automatically apply various Vocal Harmony effects to your voice as you sing, or you can use Synth Vocoder to graft the unique characteristics of your voice onto synthesizer and other sounds.

 **NOTE**

Make sure to connect a microphone before using Vocal Harmony and Synth Vocoder. For instructions on connecting a microphone and making necessary settings, refer to page 106.

Using Vocal Harmony

- 1 Call up the Vocal Harmony display via [MENU] button → [Vocal-Harmony].

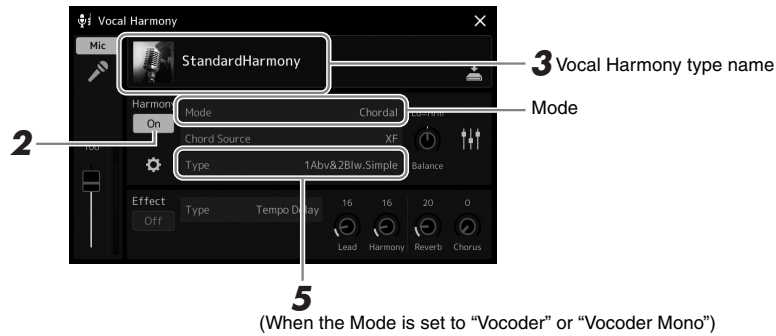

- 2 Make sure that Harmony is set to “On.”

If necessary, touch the display or press the [VOCAL HARMONY] button to turn the Harmony “On.”

- 3 Touch the Vocal Harmony name to call up the Vocal Harmony Type Selection display.





- 4 Touch the desired Vocal Harmony Type to select it.

The Vocal Harmony features three different Modes which can be selected automatically by selecting a Vocal Harmony Type.

Vocal Harmony Modes

| | |
|--------------|---|
| Chordal | The harmony notes are determined by the chords you play in the chord section (with [ACMP ON/OFF] turned on), the left hand section (with [ACMP ON/OFF] turned off and the Left part turned on) or the chord data of a Song. |
| Vocoder | The microphone sound is output via the notes you play on the keyboard or the Song playback notes. |
| Vocoder-mono | Basically the same as Vocoder; however, in this mode, only single-note melodies or lines can be played back (with last-note priority). |

Icons shown in the Vocal Harmony Type Selection display indicate the following usage cases.

| | |
|---|---|
|  (Blue) | Vocal Harmony Type of Chordal Mode |
|  (Brown) | Vocal Harmony Type of Vocoder Mode |
|  (Green) | Vocal Harmony Type having unusual effects, such as a robotic voice. |
|  (Gray) | Vocal Harmony Type without any effect. |

5 Follow the steps below, depending on which Type (and mode) you selected.

■ If you selected the Chordal Type:

5-1 Make sure that the [ACMP] button is turned on.

5-2 Play back a Style while playing chords, or play back a Song which contains chords.
Vocal harmonies based on the chords are applied to your singing.

■ If you selected the Vocoder or Vocoder-Mono Type:

5-1 As necessary, change the “Keyboard” setting to “Off,” “Upper,” or “Lower.” When “Upper” or “Lower” is selected, playing the right-hand or left-hand section of the keyboard will control the Vocoder effect. When “Off” is selected, playing the keyboard will not control the Vocoder effect.

5-2 Play melodies on the keyboard or play back a Song, and sing into the microphone.
You’ll notice that you don’t actually have to sing pitched notes. The Vocoder effect takes the words you say and applies them to the pitch of the instrument sounds.

NOTE

For Vocoder Types, the effect is applied to a maximum of three notes of the chord you play; for Vocoder-Mono, the effect is only applied to single notes (last note applied).

Using Synth Vocoder

These are special effects that graft the characteristics of your voice onto synthesizer and other sounds, for unusual machine-like or robotic effects, as well as unique choir sounds, which you can control with your own singing and playing.

- 1 Execute steps 1–3 in “Using Vocal Harmony” on page 76.
- 2 From the Vocal Harmony Type Selection display, select the Synth Vocoder category from the sub categories.

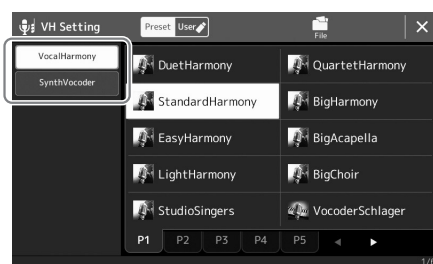

- 3 Touch the desired Synth Vocoder Type to select it.
- 4 Try holding down a note on the keyboard and speak or sing into the microphone.

Also, try changing notes as you say/sing different words, hitting a separate note for each word.

NOTE

You can change the Keyboard setting (Off/Upper/Lower), determining which part of the keyboard (or Song) controls the effect. For details, refer to the Reference manual on the website.

Singing with Song Playback—Operations While Performing

This section explains operations you can do during your singing performance with Songs: Song playback, displaying score and lyrics, adjusting the volume between two Songs, and switching microphone-related functions.

Controlling Song Playback

Song playback can be controlled by pressing buttons on the panel or from the Song playback display which is called up by pressing the [SONG] button. The control displays for SONG A and SONG B (if used) appear, allowing you to control the currently selected MIDI/Audio Song(s) on the screen.

Song Playback display

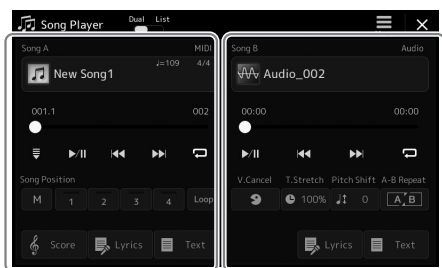

Dual Player mode (SONG A, SONG B)

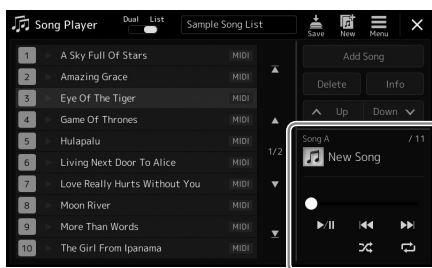

Song List mode (SONG A only)

NOTE

- For details on MIDI Song/Audio Song, switching between Song playback modes, and Song selection, refer to page 72.
- In the Song List mode, only basic playback operations are possible. On the other hand, you can play back multiple Songs continuously. For details, refer to the Reference Manual on the website.

Basic playback operations (for MIDI and Audio Songs)

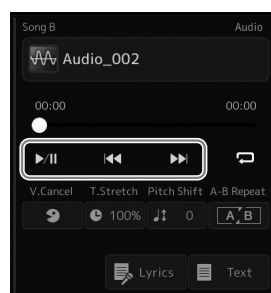
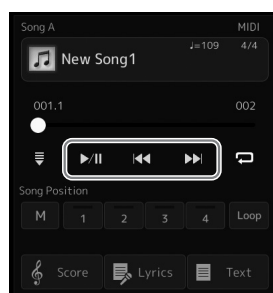
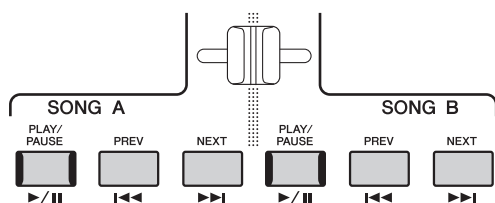

■ Play/Pause ([PLAY/PAUSE] button)

Press (or touch) [PLAY/PAUSE] (▶/||) button to start Song playback of the corresponding side (SONG A or SONG B). During playback, pressing it pauses playback. Pressing it again resumes Song playback from the current position.

■ Selecting previous/next Song ([PREV] or [NEXT] button)

Press (or touch) the [PREV] or [NEXT] (◀◀ or ▶▶) button to select the previous/next Song. In the Dual player mode, this operation selects the previous/next Song file in the same folder. At the Song List mode, this operation selects the previous/next Song on the Song List.

■ Rewind/Fast Forward ([PREV] or [NEXT] button)

Hold the [PREV] or [NEXT] (◀◀ or ▶▶) button to move backward/forward continuously through the current file.

Moving the Song Playback Position (Song Position pop-up window)

When you press or hold the [PREV] or [NEXT] button, a setting display appears showing the current position of the Song. When the window is shown on the display, you can also use the Data dial to move backward/forward continuously through the current file.

The Phrase Mark number appears only when a MIDI Song containing Phrase Marks is selected. You can select whether the Song playback position moves backward or forward in Bar or Phrase Mark units by touching the setting display beforehand.

NOTE

Phrase Mark is a pre-programmed marker in certain MIDI Song data, which specifies a specific location in the Song.

For Audio Songs

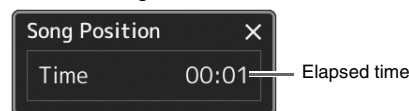

For MIDI Songs



Moving the Song Playback Position (progress bar on the display)



In each Song area, the current position of the Song playback is shown. This can be moved forward or backward by moving the slider on the display.

Playback Operations exclusively for MIDI Song

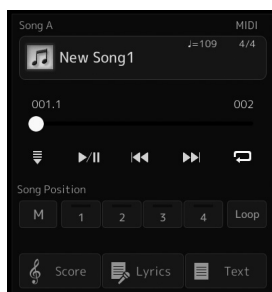

■ Synchro Start

You can conveniently start playback of a MIDI Song as soon as you start playing the keyboard. Touching  (Synchro start) puts Synchro Start in standby status, regardless of whether the Song is currently playing or stopped. To cancel the Synchro Start function, repeat the same operation.

■ Playback Using Song Position Markers ([M], [1]–[4], [Loop])

Using Song Position markers, you can not only navigate quickly and easily through the MIDI Song data, but also set up convenient playback loops, for ease in song arranging. For details, refer to “Using Song Position Markers” (page 81).

Playback Operations exclusively for Audio Song

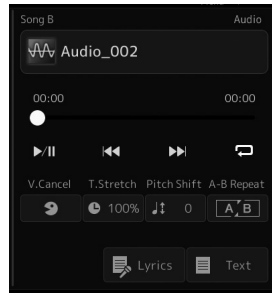



■ Vocal Cancel

This lets you cancel or attenuate the center position of the stereo sound in Audio Song playback. This lets you sing “karaoke” style with just instrumental backing, or play the melody part on the keyboard, since the vocal sound is usually at the center of the stereo image in most recordings.

To turn the Vocal Cancel function on/off, first select an Audio Song, then turn on/off  (Vocal Cancel).

■ Time Stretch

Like Tempo adjustment of a MIDI Song, this lets you adjust the playback speed of an Audio Song by stretching or compressing it. To do this, touch  100% (Time Stretch) to call up the setup window. Touch []/[] in this window to set the value (from 70% to 160%). Higher values result in a faster tempo.

■ Pitch Shift



Like the Transpose function of the MIDI Song, this lets you shift the pitch of an Audio Song in semitone steps (from -12 to 12).

■ A-B Repeat Playback

This lets you repeatedly play back a specified range (between points A and B).

1 Touch  (Play/Pause) to start playback.

2 Specify the repeat range.

When playback reaches the point you want to specify as the starting point (A), turn on  (A-B Repeat). When playback reaches the point you want to specify as the ending point (B), touch  (A-B Repeat) again. The range from Point A to Point B will be played back repeatedly.

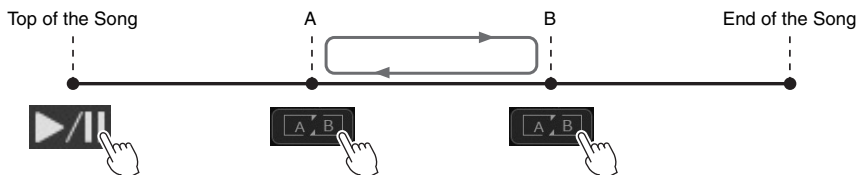

3 To cancel A-B repeat playback, turn off  (A-B Repeat).

The time of point A and B are cleared, and Repeat Playback is canceled.



NOTE

Though the Vocal Cancel function is highly effective on most audio recordings, the vocal sound on some songs may not be completely cancelled.

NOTE

- Specifying only Point A results in repeat playback between Point A and the end of Song.

Specifying the repeat range while Song playback is stopped

1. Fast-forward the Song to Point A then turn on  (A-B Repeat).
2. Fast-forward the Song to Point B then touch  (A-B Repeat) again.

Using Song Position Markers (MIDI Song only)

Song Position markers (SP1–SP4) can be placed in the MIDI Song data. This not only lets you navigate quickly and easily through the MIDI Song data, but also lets you set up convenient playback loops—allowing you to create dynamic Song arrangements “on the fly,” as you perform.

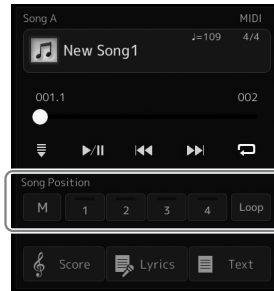

Entering Song Position Markers

- 1** Select the desired MIDI Song (page 74), and start playback (page 78).
- 2** Enter the Song Position markers.
 - 2-1** Touch **M** (Song Position Memorize) to turn it on.
 - 2-2** When the Song reaches the point at which you wish to enter a marker, touch the desired marker number ([1]–[4]) on the display. The corresponding Song Position marker is entered, and Song Position Memorize is automatically turned off.
- 3** As desired, enter other markers in the same way as step 2.
- 4** Pause Song Playback (page 78).
- 5** Save the Song.
 - 5-1** Touch the Song name to call up the Song Selection Display.
 - 5-2** Save the Song file (page 37).

NOTICE

The entered marker settings will be lost if you change to another Song or you turn the power off without executing the Save operation.

About the status of Song Position [1]–[4]

- **Off:** Song Position is not entered to the button.
- **Green:** Song Position is entered to the button.
- **Red (flashes):** Playback jump is ready. See below (“Jumping to a Song Position Marker during playback”).
- **Red:** The Song Position has been passed and Song playback continues to the next Song button.

Jumping to a Song Position Marker during playback

Simply touching the one of the Song Position [1]–[4] during Song playback jumps to the corresponding position, after the current played measure reaches its end. (The button will flash in red, indicating that playback jump is ready.) You can cancel the jump by touching the same Song Position again before the actual jump.

Starting playback from a specific Marker

First, touch one of Song Position [1]–[4] while Song playback is stopped, and then start playback (page 78).

Using Markers in loop playback

In this section, we'll explain loop playback by the example of looping between markers [1] and [2].

1 Touch  (Play/Pause) to start playback from the top of the Song.

2 After passing the [1] point, touch  (Loop) to turn the loop function on.

The Song plays back up to the [2] point, then goes back to [1] and loops between the two points.

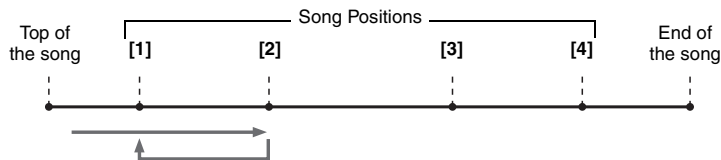

3 To stop the loop and continue normal playback, touch  (Loop) again.

When this is turned off, playback continues past the [2] point.

Displaying Score, Lyrics, and Text files during Playback

Displaying Music Notation (Score) of the MIDI Song

You can view the music notation (score) of the selected MIDI Song. We suggest that you read through the music notation before starting to practice.

1 Select a MIDI Song (page 74).

2 Touch  (Score) on the Song Playback display to call up the Score display.

You can look through the entire notation by touching [◀] or [▶] when Song playback is stopped. While the Song is playing back, the “ball” bounces along through the score, indicating the current position.

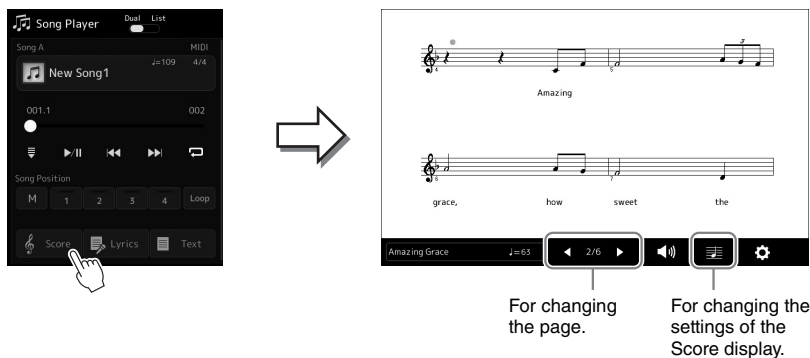

NOTE

- You can call up the Score display as well, via [MENU] → [Score].
- The instrument can display the music notation of commercially available music data or your recorded Songs.
- The displayed notation is generated by the instrument based on the Song data. As a result, it may not be exactly the same as commercially available sheet music of the same song—especially when displaying notation of complicated passages or many short notes.

Changing the Size of the Score and Displaying Lyrics in a Score

By touching the note icon shown on the lower right of the display, you can change the settings of the Score display, such as changing the size of the score, or displaying note names or lyrics within the score, and so on. For details on the Score display, refer to the Reference Manual on the website.

NOTE

Lyrics can be shown only when the Song contains lyric data.

Displaying Lyrics of the MIDI Song

When the selected Song contains lyric data, you can view it on the instrument's display during playback.

1 Select a MIDI Song (page 74).

2 Touch (Lyrics) on the Song Playback display to call up the Lyrics display.

When the Song data contains lyrics data, the lyrics are shown on the display. You can look through the entire lyrics by touching [◀] or [▶] when Song playback is stopped. While the Song is playing back, the color of the lyrics changes, indicating the current position.

NOTE

You can call up the Score display as well, via [MENU] → [Lyrics].

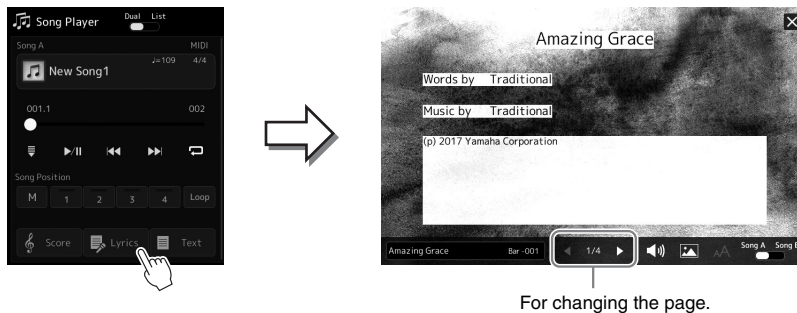

For details on the Lyrics display, refer to the Reference Manual on the website.

Displaying Text

Regardless of whether a Song is selected or not, you can view computer-created text files (.txt) on the instrument's display. To call up the display, touch  (Text) on the Song Playback display. This feature enables various useful possibilities, such as the showing of lyrics, chord charts and performance notes. For details on the Text display, refer to the Reference Manual on the website.

Adjusting the Volume Balance between SONG A and SONG B (Cross Fader)

In the Dual Player mode of Song playback, the Cross Fader lets you adjust the volume balance between SONG A and SONG B playback. Moving the fader leftward increases the volume of SONG A playback, and moving rightward increases the volume of SONG B playback.

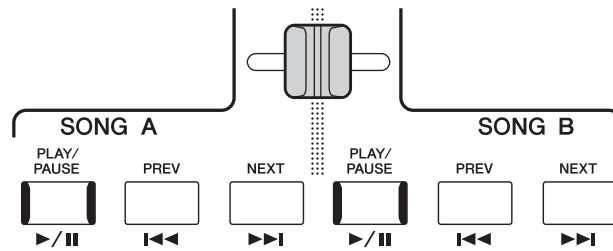

Controlling the Microphone Functions

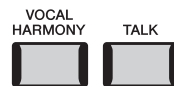

Turning Vocal Harmony On/Off

Pressing the [VOCAL HARMONY] button turns the Vocal Harmony function on/off. By using this button, you can quickly switch whether Vocal Harmony effects are applied to your voice through a microphone or not. For details on the Vocal Harmony function, including Harmony type selection, refer to page 76.

Using the Talk function

Turning the Talk function on by pressing the [TALK] button lets you instantly change the microphone settings for speaking to your audience. Vocal Harmony is not available when this function is on. This is useful when you want to make announcements between song performances without distracting reverb effects, etc.

NOTE

You can also adjust the Talk settings to suit your preferences on the "Mic Setting" display. For details, refer to the Reference Manual on the website.

Adjusting the Parameters of Each Part— Mixer

The Mixer gives you intuitive control over aspects of the keyboard parts and Song/Style channels, including volume balance and the timbre of the sounds. It lets you adjust the levels and stereo position (pan) of each Voice to set the optimum balance and stereo image, and lets you set how the effects are applied. This section covers the basic procedures for the Mixer. For details, refer to the Reference Manual on the website.

Basic Procedure for the Mixer

1 Call up the Mixer display via [MENU] → [Mixer].



2 Touch the appropriate tab for editing the balance between the desired parts.

| | |
|--------------------|---|
| Panel 1/2 | Use this display when you want to adjust the balance between the entire Style part, entire Song A part, entire Song B part, Left part, Right 1–3 parts, Multi Pad part, Mic part, Aux In part, and the Wireless LAN part (audio input via the wireless LAN function) if it is included. NOTE A wireless LAN function may not be included depending on your area. |
| Style 1/2 | Use this display when you want to adjust the balance between the channels of the Style. About each channel, refer to “Style Channels” (page 88). |
| Song Ch 1–8 / 9–16 | Use this display when you want to adjust the balance between all the parts of the MIDI Song. |
| Master | Unlike the other displays, use this display when you want to adjust the tonal characteristics of the entire sound (except for Audio Songs) of this instrument. For details on this display, refer to page 102. |

3 Touch a tab for editing the desired parameters.

| | |
|---------------|---|
| Filter | For adjusting Resonance, and Cutoff (sound brightness). |
| EQ | For adjusting equalization parameters to correct the tone or timbre of the sound. |
| Effect | For selecting an Effect type and adjusting its depth for each part. |
| Chorus/Reverb | For selecting a Chorus/Reverb type and adjusting its depth for each part. |
| Pan/Volume | For adjusting panning and volume for each part. |

4 Set the value of each parameter.

5 Save your Mixer settings.

■ To save the Panel 1/2 Mixer settings:

Register them to Registration Memory (page 93).

■ To save the Style 1/2 Mixer Settings:

Save them as a Style file to the User drive or USB flash drive. If you want to recall the settings for future use, select the Style file saved here.

- 1 Call up the operation display via [MENU] → [Style Creator].
- 2 Touch [Save] to call up the Style Selection display, then save as a Style file (page 37).

■ To save the MIDI Song Ch 1–8 / 9–16 Mixer Settings:

When editing and saving the MIDI Song Channel settings, a different operation is needed. For details, see “Editing and Saving the MIDI Song Ch 1–8 / 9–16 Mixer Settings” below.

NOTE

- To reset each parameter to the default value, touch the number value or setting and hold it.

Editing and Saving the MIDI Song Ch 1–8 / 9–16 Mixer Settings

First select a MIDI Song, and edit the parameters. Second, register the edited settings as part of the MIDI Song data (Setup), then save the Song to the User drive or USB flash drive. If you want to recall the settings for future use, select the Song file saved here.

- 1 Call up the operation display via [RECORDING] → MIDI [Multi Recording].
- 2 Touch the Song name “New Song” to call up the Song Selection display, then select the desired Song.
- 3 Edit the desired parameters, according to “Basic Procedure for the Mixer” (page 86) steps 1–4.
- 4 Press the [RECORDING] button to call up the MIDI Multi Recording display again.
- 5 Register the edited settings to the MIDI Song.
 - 5-1 Touch [Setup] to call up the Setup display.
 - 5-2 Touch [Execute] to register the edited settings as part of the MIDI Song data.
- 6 Touch [Save] to call up the Song Selection display, then save as a Song file (page 37).

Turning Each Channel of the Style or MIDI Song On/Off

You can add variations and change the feeling of a Style or a MIDI Song by selectively turning channels on/off.

Style Channels

Each Style contains the channels listed below.

- **Rhythm 1/2:** These are the basic parts of the Style, containing the drum and percussion rhythm patterns.
- **Bass:** The bass part uses various appropriate instrument sounds to match the Style.
- **Chord 1/2:** These are the rhythmic chord backing, commonly consisting of piano or guitar Voices.
- **Pad:** This part is used for sustained instruments such as strings, organ, choir, etc.
- **Phrase 1/2:** These parts are used for punchy brass stabs, arpeggiated chords, and other extras that make the accompaniment more interesting.

1 In the Mixer display, touch the [Style 1/2] tab, [Song 1-8] tab or [Song 9-16] tab.

2 Touch the Channel which you want to turn on/off.



If you want to play back only one particular channel (solo playback), touch and hold the desired channel until the number is highlighted in purple. To cancel solo, simply touch the (purple) channel number again.

3 As necessary, make other settings then save them as a Style file or Song file (step 5 on page 87).

Changing the Voice for Each Channel of the Style or MIDI Song

You can change the Voice for each channel via the Mixer display.

- 1** In the Mixer display, touch the [Style 1/2] tab, [Song 1-8] tab or [Song 9-16] tab.
- 2** Touch the instrument icon below the channel name to call up the Voice Selection display, then select the desired Voice.



- 3** As necessary, make other settings then save them as a Style file or Song file (step 5 on page 87).

6

Song Recording

This instrument allows you to record your performance in two ways: MIDI recording and Audio recording. In addition, each way of recording features two different methods: Quick Recording, which is the easiest, most convenient way to record, and Multi Recording, which allows you to record each channel or each track independently. In this section, we'll take a look at MIDI Quick Recording and Audio Quick Recording.

■ MIDI Quick Recording

With this method, recorded performances are saved to the instrument or a USB flash drive as an SMF (format 0) MIDI file. If you want to re-record a specific section or change Voices and edit other parameters, use this method. This instrument allows you to record approximately 300 KB per Song.

■ Audio Quick Recording

With this method, recorded performances are saved to the instrument as an Audio file. Recording is done without designating the recorded part. Since it is saved in stereo WAV format of normal CD quality resolution (44.1kHz/16-bit) by default, it can be transmitted to and played on portable music players by using a computer. This instrument allows you to record up to 80 minutes per single recording.

Multi Recording

- **MIDI Multi Recording:** This lets you create a MIDI Song consisting of 16 channels by recording your performance to each channel one by one.
- **Audio Multi Recording:** This lets you record your performance several times to make up the complete song, or record additional performances to an existing Audio file.

For details on Multi Recording, refer to the Reference Manual on the website.

MIDI Quick Recording

Before recording, make the necessary settings such as Voice/Style selection. As necessary, connect the USB flash drive to the [USB TO DEVICE] terminal. With this type of recording, each part will be recorded to the following channels.

- **Keyboard parts:** channels 1–4
- **Multi Pad parts:** channels 5–8
- **Style parts:** channels 9–16

1 Call up the MIDI Quick Recording display via [RECORDING] → MIDI [Quick Recording].

The display appears and a new blank Song is automatically set to record standby status.

NOTE

- Audio data such as the rhythm channels created via the audio data of Audio Link Multi Pad and Audio Songs cannot be recorded to the MIDI Songs.
- Before using a USB flash drive, be sure to read "Connecting USB Devices" on page 111.

NOTE

To cancel the recording, touch [Stop] on the display, and then press the [EXIT] button, before going on to step 2.

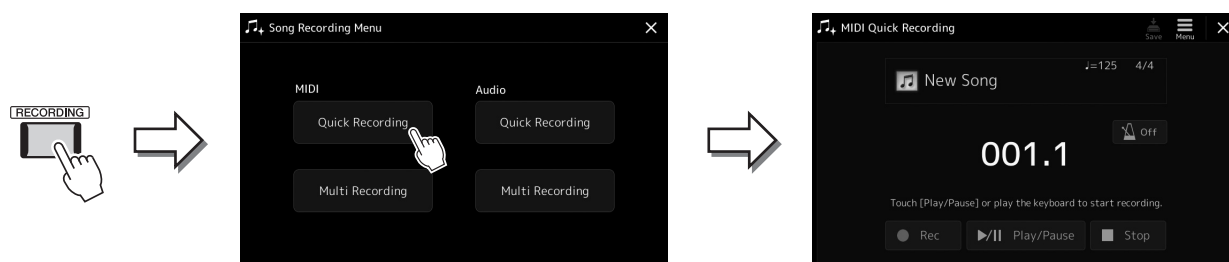

2 Start recording.

You can start recording by playing the keyboard, starting the Style, playing a Multi Pad or touching [Play/Pause].

3 After you finish your performance, touch [Stop] to stop recording.

4 Touch [Save] to call up the Song Selection display, then save the recorded performance as a file (page 37).

NOTICE

The recorded Song will be lost if you close the display or you turn the power off without executing the save operation.

Audio Quick Recording

Before recording, make the necessary settings such as Voice/Style selection and the microphone connection (if you want to record your singing).

1 Call up the Audio Quick Recording display via [RECORDING] → Audio [Quick Recording].

The display appears and a new empty audio file is created, with record standby status enabled. However, unlike MIDI Quick Recording, recording does not start automatically with keyboard performance, Style playback, or Multi pad playback.

NOTE

To cancel the recording, touch [Stop] on the display, and then press the [EXIT] button, before going on to step 2.

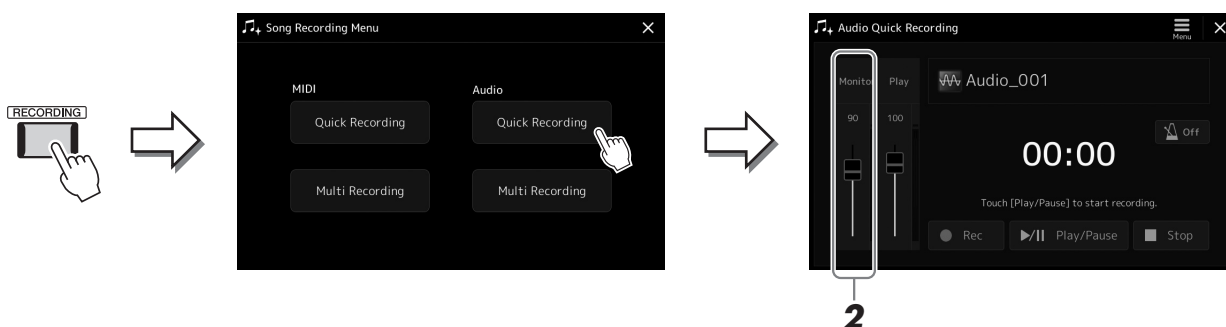

2 Before recording, check the recording levels on the Rec Monitor meter by playing the keyboard, Style, etc., and adjust them accordingly by using the corresponding slider.

Adjust the control so that the volume doesn't constantly go into the "red" and light up the indicator.

3 Touch [Play/Pause] to start recording.

Immediately after this operation, start and record your performance.

4 After you finish performance, touch [Stop] to stop recording.

Recorded data is automatically saved to User drive as a file with the name automatically set. The recorded Audio Song appears in the User category on the Song Selection display.

Storing and Calling up Custom Panel Set-ups—Registration Memory, Playlist

The Registration Memory function and the Playlist function allow you to save (or “register”) virtually all panel settings, and then instantly recall your custom panel settings for your performances by a simple, one-touch operation. The Playlist is especially useful for managing your repertoire, letting you select only the desired panel settings from the huge repertoire in the Registration Memory and create a new list.

■ Registration Memory

This function allows you to save (register) your custom panel settings to one of the Registration Memory buttons for easy recall.

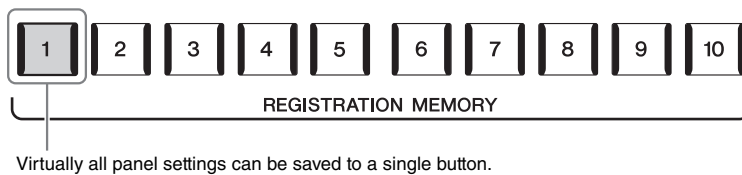

There are ten Registration Memory buttons on the panel. You can save all ten registered panel setups as a Single Registration Memory Bank file.

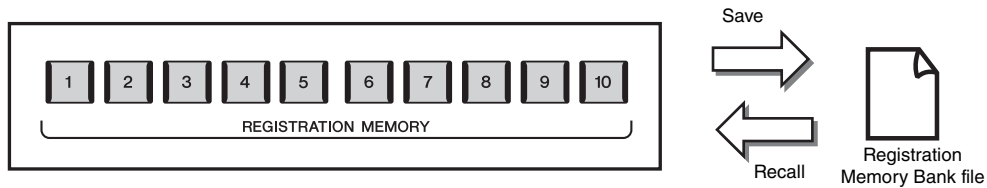

NOTE

For information on the parameters that can be registered with the Registration Memory function, refer to the Registration section of the “Parameter Chart” in the Data List on the website.

■ Playlist

The Playlist function allows you to create your own live performance set list. You can select only the desired files from the huge number of the Registration Memory Bank files without changing the bank file configuration. Each Playlist Record can directly recall a specified Registration Memory in the selected Registration Memory Bank file. You can collectively store the Playlist Records as a single Playlist file.

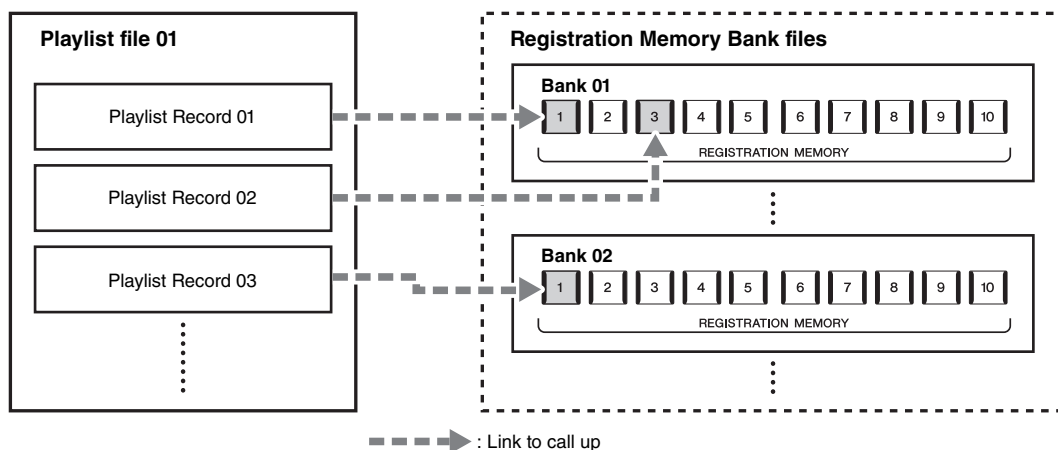

Saving and Recalling Custom Panel Setups with Registration Memory

Registering Your Panel Setups

- 1** Make the desired panel Settings, such as those for Voices, Styles and Effects.
- 2** Press the [MEMORY] button in the REGISTRATION MEMORY section to call up the Registration Memory window.

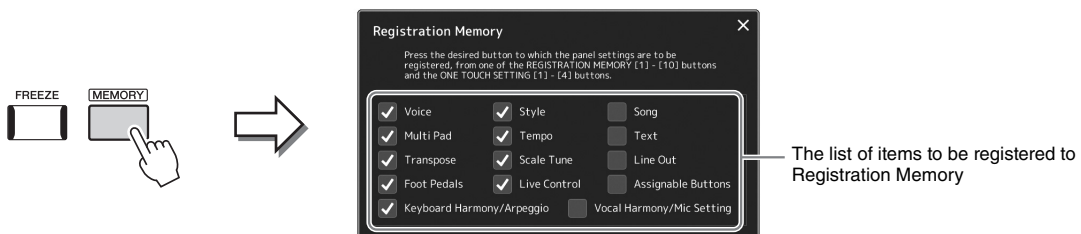

Selecting the items to be registered

The Registration Memory window contains the list for selecting the items to be registered. Before going on to step 3, enter or remove checkmarks by touching the desired items. Items having checkmarks will be registered.

- 3** Press the desired REGISTRATION MEMORY [1]–[10] button to which you wish to memorize the panel setup.

The memorized button lights in red, which indicates that the button contains data and its number is selected.



About the lamp status

- **Red:** Data registered and currently selected
- **Blue:** Data registered but not currently selected
- **Off:** No data registered

- 4** Register various panel setups to other buttons by repeating steps 1–3.

The registered panel setup can be recalled by simply pressing the desired number button.

NOTICE

If you selected a button whose lamp is lit in red or blue here, the panel setup previously memorized to the button will be erased and replaced by the new settings.

NOTE

The panel setups registered in the numbered buttons are maintained even when you turn off the power. If you want to delete all ten current panel setups, turn the power on while holding the F# 6 key (second right-most key) on the keyboard.

Saving the Registration Memory as a Bank file

You can save all ten registered panel setups as a Single Registration Memory Bank file.

- 1 Press the REGIST BANK [-] and [+] buttons simultaneously to call up the Registration Bank Selection display.**

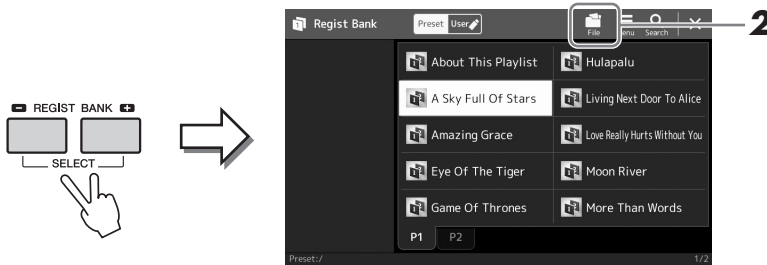

- 2 Touch  (File Edit) to call up the pop-up window, and then touch [Save] to save the Bank file.**

For instructions on saving, refer to “File Management” (page 37).

NOTE

You can tag Registration Memory Bank files for easy search. For details, refer to the Reference Manual on the website.

Recalling a Registered Panel Setup from a Bank file

The saved Registration Memory Bank files can be recalled by using the REGIST BANK [-]/[+] buttons or the following procedure.

- 1 Press the REGIST BANK [-] and [+] buttons simultaneously to call up the Registration Bank Selection display.**
- 2 Touch and select the desired Bank on the display.**
You can also use the REGIST BANK [-]/[+] buttons to select a Bank.
- 3 Press one of the blue-lit numbered buttons ([1]–[10]) in the Registration Memory section.**

The selected button lights in red.

NOTE

- When recalling setups that include Song, Style or text files selected from a USB flash drive, make sure that the appropriate USB flash drive containing the registered Song, Style or text is connected into the [USB TO DEVICE] terminal.
- Before using a USB flash drive, be sure to read “Connecting USB Devices” on page 111.

NOTE

Turning the [FREEZE] button on lets you disable recall of specific item(s) as desired. For instructions, refer to the Reference Manual on the website.

NOTE

You can also call up the ten setups by using pedals or Assignable buttons in any order you specify via [MENU] → [Regist Sequence]. For details, refer to the Reference Manual on the website.

Confirming the Registration Memory Bank Information

You can call up the information display to confirm which Voices, Style and Songs are memorized to the [1]–[10] buttons of a Registration Memory Bank.

1 Call up the Registration Bank Selection display, then select the desired Bank.

2 Touch  (Menu) then [Regist Bank Info] to call up the Regist Bank Information display.

This display consists of two pages: Voice-related, and Style-related. You can switch between the two via [Voice]/[Style] on the display.

 **NOTE**

If a certain Voice part is set to off, the Voice name for the corresponding part is shown in gray.

For switching pages.

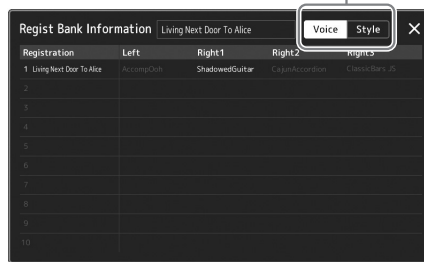

Touch to select the desired Registration Memory. The selected Registration is automatically loaded.

3 Press the [EXIT] button to close the information display.

Editing a Registration Memory Bank

You can edit a Registration Memory Bank (delete or rename each Registration Memory, etc.) in the Regist Bank Edit display.

1 Call up the Registration Bank Selection display, then select the desired Bank.

2 Touch  (Menu) then [Regist Bank Edit] to call up the Regist Bank Edit display.

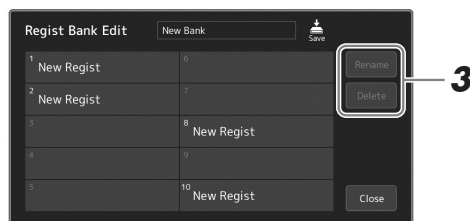

3 Edit the Registration Memory Bank information.

Touch to select the desired Registration Memory. The Registration Memory is selected as a editing target, but not actually loaded.

- To change the name of the selected Registration, touch [Rename].
- To delete the selected Registration, touch [Delete].

4 Touch  (Save) to save the edited Registration Memory Bank file.

Managing a Large Repertoire by Using the Playlist

The Playlist is useful for managing multiple set lists for your live performances. You can select only the desired files from a large repertoire (the huge number of the Registration Memory Bank files) and create a new set list for each performance.

Adding a Record to the Playlist

By adding a Record to the Playlist, you can directly recall your desired Registration Memory.

1 Press the [PLAYLIST] button to call up the Playlist display.

The Playlist file which was selected the last time appears. (The sample preset Playlist will appear for the first time.)

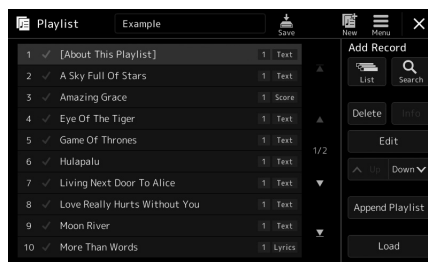

2 Add a Record to the Playlist.

● To add a Record via the Registration Bank Selection display:

2-1 Touch Add Record [List] on the display.

The Registration Bank Select display appears.

2-2 Select the desired Registration Bank file to register as a Playlist Record.

Touching [Add to Playlist] closes the display, and the new Playlist Record is added to the Playlist.

● To add a Record by using the search function:

Touching Add Record [Search] on the display calls up the operation display for searching the desired Registration Bank file. For details on searching for files, refer to the Reference Manual on the website.

From the search result, select the desired file and then touch [Add to Playlist] to close the display, and the new Playlist Record is added.

3 If necessary, edit the Playlist Record.

The newly added Playlist Record simply recalls the selected registration Bank file. If you want to set more detailed settings (such as directly recalling a specified Registration Memory and automatically switching the screen view), you can edit the Playlist Record.

3-1 Touch [Edit] to call up the Record Edit display.

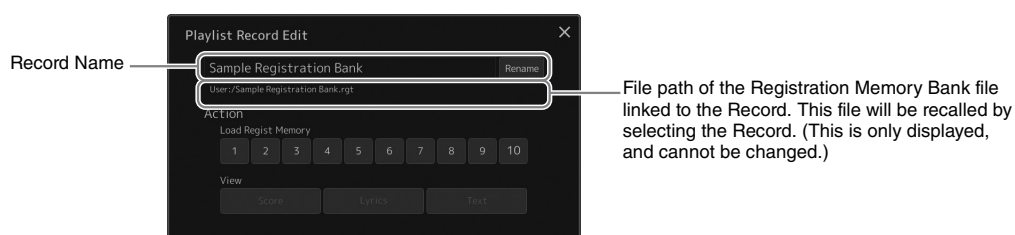

3-2 Touch to edit the Record.

| | |
|-------------|--|
| Record Name | Determines the name of the Record. Touching [Rename] calls up the Character Entry window. |
| Action | Additional actions after selecting the Record and recalling the Bank. <ul style="list-style-type: none"> • Load Regist Memory: Recalls the Registration Memory corresponding to the selected number. When no item is selected, no Registration Memory is recalled. • View: Displays the selected view. When no item is selected, no view is displayed. |

3-3 Close the display.

4 Touch  (Save) to save the added Record to the current Playlist file.

To recall the registered Record, touch the desired Record on the Playlist display.

Recalling custom panel setups via the Playlist

1 Press the [PLAYLIST] button to call up the Playlist display.



2 Touch the Playlist file name to call up the Playlist File Selection display.

3 Touch the desired Playlist file, and then close the display.

4 Touch the Record name on the Playlist display, and then touch [Load].

The Registration Memory Bank registered as the Playlist Record is recalled and the Action you've made is executed (page 96.)

Creating a new Playlist

1 Press the [PLAYLIST] button to call up the Playlist display.

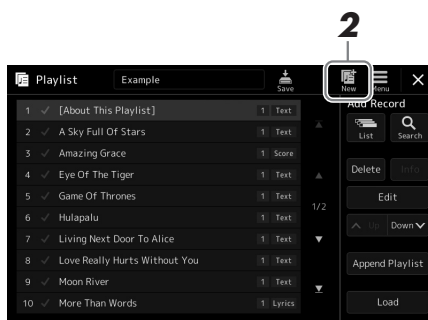

2 Touch  (New) on the display.
A new Playlist file is created.

Copying the Playlist Records (Append Playlist)

“Append Playlist” allows you to copy the existing Playlist file as a new Playlist file.



1 Press the [PLAYLIST] button to call up the Playlist display.

2 Touch [Append Playlist] on the display.
The Playlist File Selection display appears.

3 Touch the desired Playlist file to append.
All Records in the selected Playlist file are added at the bottom of the current Playlist.

4 Touch  (Save) to save the appended Records to the current Playlist file.

Changing the order of the Records in the Playlist

- 1** Press the [PLAYLIST] button to call up the Playlist display.
- 2** Change the order of the Records.
 - 2-1** Touch the desired Record you want to move.
 - 2-2** Touch  Up (Up)/  (Down) to move the Record you selected in Step 2-1.
- 3** Touch  (Save) to save the edited Playlist file.

Deleting the Playlist Record from the Playlist

- 1** On the Playlist display, touch the desired Record to select it.
- 2** Touch [Delete] on the display.

A confirmation message appears here. To cancel the deletion, touch [No].
- 3** Touch [Yes].
- 4** Touch  (Save) to save the edited Playlist file.

Customizing for Optimum Performance

You can customize the instrument for your own personal preferences and optimum performance. This section covers how to edit shortcuts on the Home display, set ASSIGNABLE buttons, make global settings, adjust the sound at the final output, and add expansion contents, such as Voices and Styles.

Customizing the Shortcuts on the Home Display

You can register an often used function to a shortcut on the Home display. Although six shortcuts are registered by default, you can customize them as necessary. Registered shortcuts are shown in the Shortcut area (page 30) at the bottom of the Home display, allowing you to quickly call up the desired function from the Home display.

- 1 Call up the Assignable display via [MENU] → [Assignable].

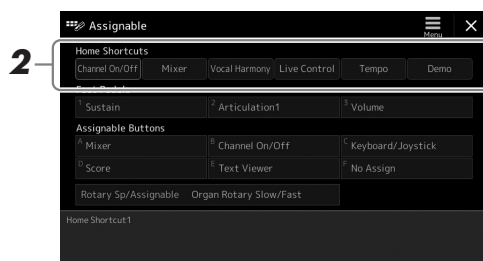

- 2 Double-tap (touch twice) the desired item from the six locations of the “Home Shortcuts” area.

The function selection pop-up window appears.

- 3 Touch the desired function.

The function will be registered to the location selected in step 2.

Setting the Functions or Shortcuts to the ASSIGNABLE Buttons

You can assign various control functions or shortcuts to the ASSIGNABLE [A]–[F] buttons, allowing you to quickly operate or call up the desired function.

- 1 Call up the Assignable display via [MENU] → [Assignable].

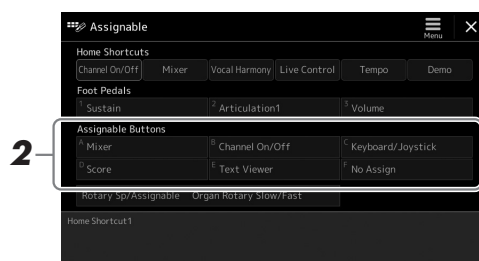

- 2 Double-tap (touch twice) the desired item from the “Assignable Buttons” area.

The function selection pop-up window appears.

- 3 Touch the desired function.

The function will be registered to the location selected in step 2.

NOTE

For details on assignable parameters and functions, refer to the Reference Manual on the website.

Making Global Settings (Utility)

The Utility function provides a variety of convenient tools and settings for Genos. These include general settings that affect the entire instrument, as well as detailed settings for specific functions. Also included are data reset functions and storage media control, such as disk formatting.

Basic Procedure

1 Call up the operation display.

[MENU] → [Utility]

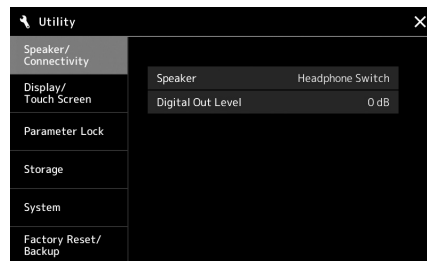

2 Touch the desired tab to call up the desired page, and change the settings or execute the operation.

| | |
|----------------------|--|
| Speaker/Connectivity | Determines how the sound is output from the speaker, and the digital output volume. |
| Display/Touch Screen | Contains display-related settings such as brightness, display speed, and touch sound On/Off settings. |
| Parameter Lock | Specifies the parameters to make them selectable only via the panel control. |
| Storage | Lets you execute the Format operation or check the memory capacity (approximate value) of the USB flash drive connected to this instrument. (page 112) |
| System | Indicates the firmware version and the hardware ID of this instrument, and lets you make basic settings, such as the language for the display, Auto Power Off function On/Off. (pages 24, 104) |
| Factory Reset/Backup | Backs up/restores whole or a part of the instrument or initializes the instrument to the factory default. (page 105) |

For more information of each tabs, refer to the “Utility” of the Reference Manual on the website.

Adjusting the Sound at the Final Output (Master Compressor, Master EQ)

You can adjust the sound quality and the volume at the final output from Genos by making the Master Compressor and the Master EQ settings.

1 Call up the Mixer display via [MENU] → [Mixer].

2 Touch the “Master” tab.



3 Touch a tab for editing the desired parameters.

| | |
|------------|---|
| Compressor | Lets you turn the Master Compressor (which is applied to the entire sound except audio playback) on or off, select the Master Compressor type, and edit the related parameter Your original edits can be saved as the Master Compressor type. |
| EQ | Lets you select the Master EQ type applied to the entire sound except audio playback and edit the related parameters. Your original edits can be saved as the Master EQ type. |

NOTE

For more information about these parameters, refer to the Reference Manual on the website.

4 Set the value of each parameter.

5 Save the settings.

Your original edits can be stored as a Master Compressor type and Master EQ type. If you want to recall the settings for future use, select the corresponding type at the upper right of each display.

5-1 Touch  (Save) in the “Compressor” display or “EQ” display.

5-2 Select one of USER1–USER5 in the “Compressor” display or USER1–USER2 in the “EQ” display, then touch [Save] to call up the Character Entry window.

5-3 In the Character Entry window, change the name as necessary, then touch [OK] to save the data.

NOTE

To reset each parameter to the default value, touch the number value or setting and hold it.

Adding New Contents—Expansion Packs

By installing Expansion Packs, you can add a variety of optional Voices and Styles to the “Expansion” folder in the User drive. The installed Voices and Styles can be selected via the User tab in the Voice or Style Selection displays, allowing you to expand your music performance and creation possibilities. You can get high quality Expansion Pack data created by Yamaha, or create your own original Expansion Pack data by using the “Yamaha Expansion Manager” software on your computer. For instructions on how to install the Expansion Packs, refer to the Reference Manual on the website.

For more information about Expansion Packs, access the Sound & Expansion Libraries page at the Yamaha MusicSoft website:

<https://www.yamahamusicsoft.com/sound-and-expansion-libraries/>

To obtain the Yamaha Expansion Manager software and its manuals, access the following website, and search by the model name “Genos.”

<http://download.yamaha.com/>

This section explains how to make important overall, system-related settings, including backup/restore of settings and file data.

Confirming the Firmware Version and Hardware ID

You can check the firmware version and hardware ID of this instrument.

1 Call up the operation display via [MENU] → [Utility].

2 Touch [System].

The program version and the hardware ID are shown in the display.

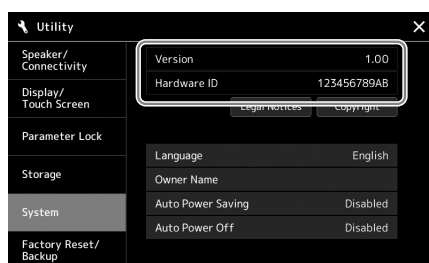

Restoring the Factory-programmed Settings

While holding the right-most key on the keyboard, turn the power on. This restores all settings to the factory default.

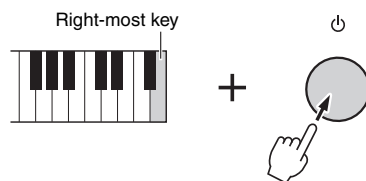

NOTE

- You can also restore the factory default value of specified settings or delete all files/folders in the User drive on the display called up via [MENU] → [Utility] → [Factory Reset/Backup] → page 1/2. For details, refer to the "Utility" of the Reference Manual on the website.
- If you simply want to restore the default value of any parameter you've changed, touch and hold the value on the display (page 34).

Data Backup and Restore

Data Backup

You can back up all data in the User drive of this instrument (except for Expansion Voices/Styles) and all settings to the USB flash drive as a single file. This procedure is recommended for data security and backup in case of damage.

- 1** Connect the USB flash drive to the [USB TO DEVICE] terminal as backup destination.
- 2** Call up the display via [MENU] → [Utility] → [Factory Reset/Backup] → page 2/2.

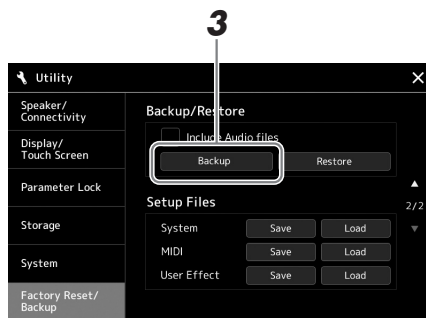

If you want to include the audio files to the backup file:

Before going on to step 3, enter a checkmark by touching the “Include Audio files” checkbox.

- 3** Touch [Backup] to save the backup file to the USB flash drive.

Restoring the Backup file

To do this, touch [Restore] in step 3 above. When the operation is complete, the instrument will be restarted automatically.

NOTE

- Before using a USB flash drive, be sure to read “Connecting USB Devices” on page 111.
- You can back up User data such as Voice, Song, Style, and Registration Memory by copying them individually to a USB flash drive. For instructions, refer to page 37.
- If the total size of the target data for backup exceeds 3.9 GB (excluding Audio files), the backup function is not available. If this happens, back up the User data by copying the items individually.
- You can save the System settings, MIDI settings, User Effect settings, and Playlist Records individually.

NOTICE

- **Completing the backup/restore operation may take a few minutes. Do not turn off the power during backup or restoring. If you turn off the power during backup or restoring, data may be lost or damaged.**

Connections—Using Your Instrument with Other Devices

This chapter covers the connections of this instrument to other devices. To see where the connectors are located on the instrument, refer to pages 18–21.

CAUTION

Before connecting the instrument to other electronic components, turn off the power of all components. Also, before turning any components on or off, make sure to set all volume levels to minimum (0). Otherwise, damage to the components, electrical shock, or even permanent hearing loss may occur.

Connecting a Microphone ([MIC INPUT] jack)

By connecting a microphone, you can sing along with your keyboard performance or with Song playback, as well as record your vocal performance to an Audio Song. Make sure you have a dynamic microphone or a condenser microphone.

About Dynamic and Condenser Microphones

- A dynamic microphone reduces vibration noise, making it good for live performances. Power is not required.
- A condenser microphone is mainly used for vocals and other instruments in environments such as a recording studio, since it is more sensitive to delicate sounds. For this reason, you need to take greater care to minimize vibrations than with a dynamic microphone. The condenser microphone requires phantom power supply (+48V), which it receives from Genos by connecting with an XLR connector.

Connecting a microphone to the instrument

- 1** Set the [MASTER VOLUME] knob and the [MIC GAIN] knob to the minimum position.

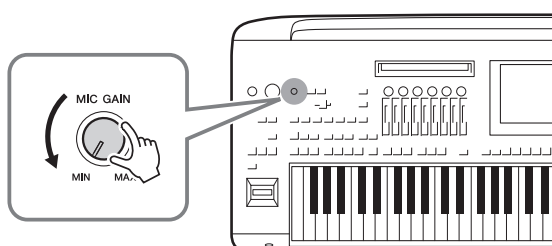

- 2** Set the [+48V] switch to off.

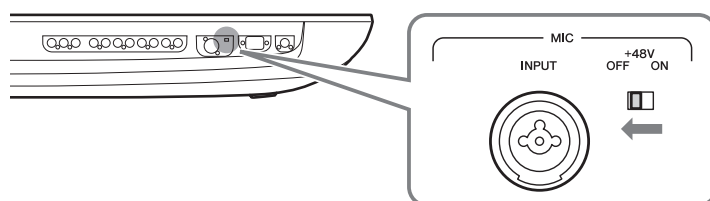

3 Connect a microphone to the [MIC INPUT] jack.

For dynamic microphone connection, use the XLR connector or a standard 1/4" phone plug connector. For a condenser microphone, use the XLR connector.

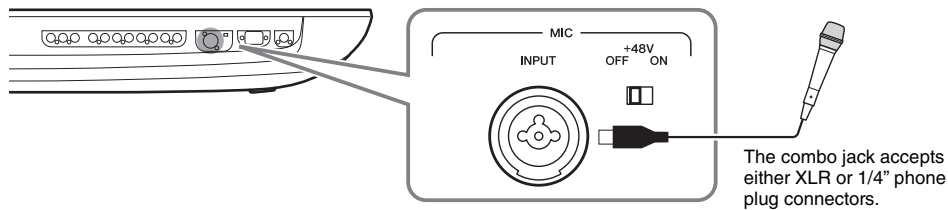

4 When using a condenser microphone, turn the [+48V] switch on.

5 Return the [MASTER VOLUME] dial to the original level.

NOTICE

- Do not connect or disconnect any cables while turning on the [+48V] switch. Doing so can damage the connected device and/or the instrument itself.
- When using the devices not requiring phantom power such as a dynamic microphone, make sure to set the [+48V] switch to OFF.

NOTE

When the [+48V] switch is turned on and off, the input from the [MIC IN] jack will be muted for a few seconds.

Adjusting the input level of the microphone

1 If necessary, turn on the microphone.

2 Call up the Mic Setting display via [MENU] → [Mic Setting].

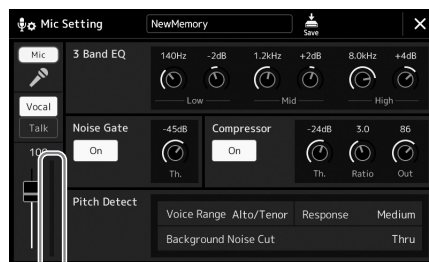

Input level meter

3 Adjust the [MIC GAIN] knob while singing into the microphone.

Adjust the [MIC GAIN] knob so that the input level meter on the display lights in green or yellow. Make sure that the meter does not light in orange or red, since this indicates that the input level is too high.

NOTE

You can also check the input level on the SIGNAL lamp on the panel. Make sure that the lamp does not light in red.

4 Adjust the volume balance between the microphone sound and the instrument sound on the Mixer display (page 86).

Disconnecting the microphone

- 1 Set the [MASTER VOLUME] knob and the [MIC GAIN] knob to the minimum position.
- 2 Set the [+48V] switch to off.
- 3 When using a condenser microphone, wait more than 10 seconds.
- 4 Disconnect the microphone from the [MIC INPUT] jack.

NOTICE

Disconnecting immediately can damage the condenser microphone and/or the instrument itself.

Connecting the Optional Yamaha GNS-MS01 Speaker

Use the [TO RIGHT SPEAKER], [TO LEFT SPEAKER] and [TO SUB WOOFER] jacks. Refer to page 116.

Connecting Audio Devices (LINE OUT jacks, AUX IN jacks, [DIGITAL OUT] jack)

IMPORTANT

Since Genos has no built-in speakers, you need to monitor its sound output via external audio equipment. Alternatively, you can use a pair of headphones (page 22).

Using external audio devices for playback (LINE OUT jacks)

The LINE OUT jacks are used to send Genos output to a keyboard amplifier, stereo sound system or mixing console. If you are connecting Genos to a mono sound system, use only the LINE OUT MAIN [L/L+R] jack. When only this jack is connected (using a standard phone plug), the left and right channels are combined and output through this jack—providing a convenient mono mix of Genos's stereo sound.

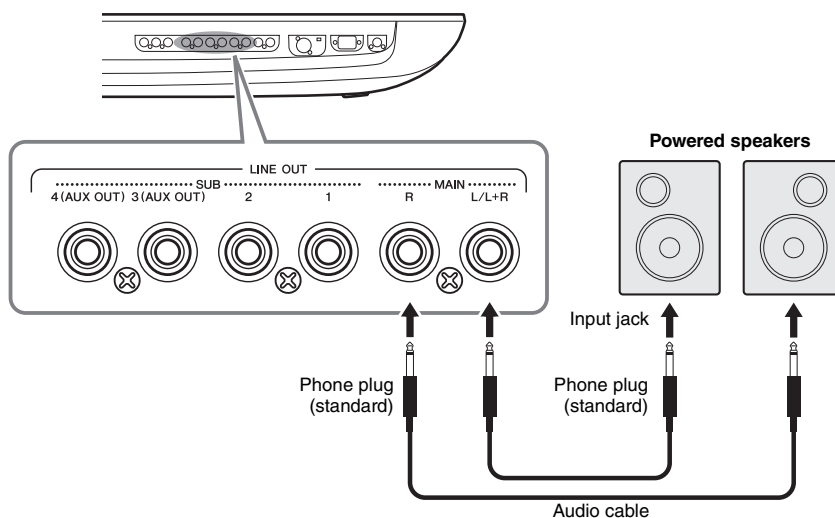

NOTE

- You can send a specific part to any desired LINE OUT SUB jack. The operation display can be called up via: [MENU] → [Line Out]. For details, refer to the Reference Manual on the website.
- You can also use the [DIGITAL OUT] jack instead of the LINE OUT MAIN jacks. However, the output volume from [DIGITAL OUT] cannot be controlled by MASTER VOLUME.

NOTICE

To avoid possible damage, first turn on the power to the instrument, then to the external device. When turning off the power, first turn off the power to the external device, then to the instrument. Since this instrument's power may automatically be turned off due to the Auto Power Off function (page 24), turn off the power to the external device, or disable Auto Power Off when you do not intend to operate the instrument.

Using the LINE OUT SUB [3]–[4] jacks as AUX OUT jacks

You can switch the function of the LINE OUT SUB [3]–[4] jacks to AUX OUT jacks from the instrument's display called up via [MENU] → [Line Out]. For details, refer to the Reference Manual on the website.

NOTICE

Do not route the output from the AUX OUT jacks to the AUX IN jacks. If you make this connection, the signal input at the AUX IN jacks is output from the AUX OUT jacks, possibly resulting in a feedback loop that will make normal performance impossible, and may even damage the equipment.

NOTE

The output volume from AUX OUT jacks cannot be controlled by the MASTER VOLUME control.

Using the [DIGITAL OUT] jack

The [DIGITAL OUT] jack has the same output signal as the LINE OUT MAIN jacks.

By using this jack, you can record the keyboard performance or Song playback of this instrument to external media (e.g., a computer or CD recorder) with exceptionally high-quality sound—thanks to the direct digital connection.

Use this connector to output digital signals via a coaxial (RCA-pin) cable. The digital signal format is CD/DAT (S/PDIF). This connector outputs a digital signal of 44.1 kHz/24 bit.

NOTE

The output volume from the [DIGITAL OUT] jack cannot be controlled by the MASTER VOLUME control. To control the digital output volume, adjust the Digital Out Level on the following display: (called up via [MENU] → [Utility] → [Speaker/Connectivity]).

Playing External Audio Devices with Genos (AUX IN jacks)

You can connect the output jacks of an external device (such as CD player, portable audio player, tone generator, etc.) to the instrument's AUX IN [L/L+R]/[R] jacks, letting you hear the sound of that device through the headphones or the optional Yamaha GNS-MS01 speakers of Genos.

NOTICE

To avoid damage to the devices, first turn on the power to the external device, then to the instrument. When turning off the power, first turn off the power to the instrument, then to the external device.

NOTE

- Use only the [L/L+R] jack for connection with a monaural device.
- The input signal from the AUX IN jacks is affected by the setting of the instrument's [MASTER VOLUME] dial, and the volume balance with other parts such as entire keyboard can be adjusted by the Mixer display (page 86).

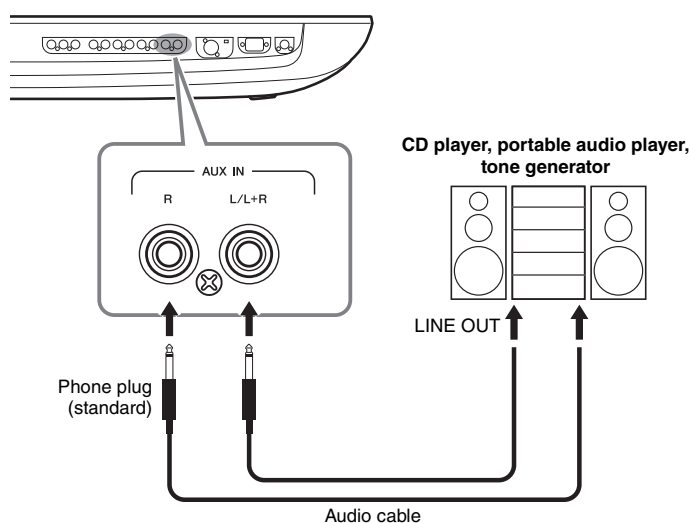

Connecting Footswitches/Foot Controllers (ASSIGNABLE FOOT PEDAL jacks)

One or two optional Yamaha FC4A or FC5 Footswitches and an optional Yamaha FC7 Foot Controller can be connected to these ASSIGNABLE FOOT PEDAL jacks. A footswitch can be used for switching functions on and off, while a foot controller can be used to control continuous parameters, such as volume.

 **NOTE**

Do not connect or disconnect any of the pedals when the power is on.

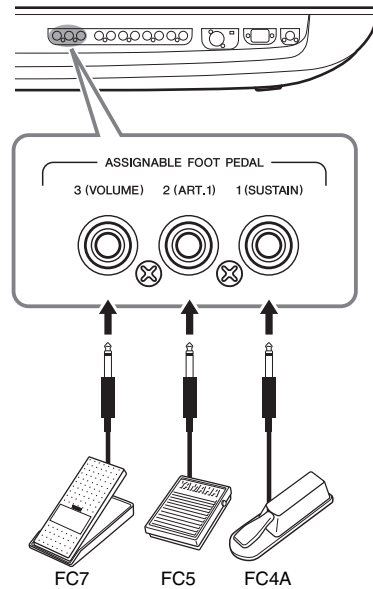

With the initial factory settings, each jack features the following function.

- **1 (SUSTAIN)**Controls sustain.
- **2 (ART. 1)**Controls an articulation effect on a Super Articulation/Super Articulation 2 Voice.
- **3 (VOLUME)**Controls volume.

You can also change the function assignments to the pedals as desired.

● Example: Controlling SONG A start/stop by footswitch

Connect a footswitch (FC4A or FC5) to one of the ASSIGNABLE FOOT PEDAL jacks. To assign the function to the connected pedal, select “Song A Play/Pause” in the operation display: [MENU] → [Assignable].

 **NOTE**

For a list of the functions you can assign to the pedals, refer to the Reference Manual on the website.

Connecting USB Devices ([USB TO DEVICE] terminal)

You can connect a USB flash drive to the [USB TO DEVICE] terminal, and save data you've created on the instrument to the drive (page 37).

Precautions when using the [USB TO DEVICE] terminal

This instrument features a built-in [USB TO DEVICE] terminal. When connecting a USB device to the terminal, be sure to handle the USB device with care. Follow the important precautions below.

NOTE

For more information about the handling of USB devices, refer to the owner's manual of the USB device.

● Compatible USB devices

- USB flash drive

Other USB devices such as a USB hub, computer keyboard or mouse cannot be used.

The instrument does not necessarily support all commercially available USB devices. Yamaha cannot guarantee operation of USB devices that you purchase. Before purchasing a USB device for use with this instrument, please visit the following web page:

<http://download.yamaha.com/>

Although USB devices 1.1 to 3.0 can be used on this instrument, the amount of time for saving to or loading from the USB device may differ depending on the type of data or the status of the instrument.

NOTE

The rating of the USB TO DEVICE terminal is a maximum of 5V/500mA. Do not connect USB devices having a rating above this, since this can cause damage to the instrument itself.

● Connecting a USB device

When connecting a USB device to the [USB TO DEVICE] terminal, make sure that the connector on the device is appropriate and that it is connected in the proper direction.

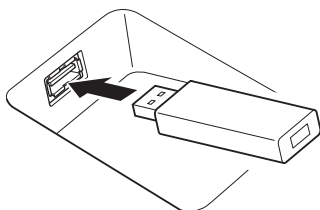

NOTICE

- Avoid connecting or disconnecting the USB device during playback/recording and file management operations (such as Save, Copy, Delete and Format), or when accessing the USB device. Failure to observe this may result in "freezing" of the operation of the instrument or corruption of the USB device and the data.
- When connecting then disconnecting the USB device (and vice versa), make sure to wait a few seconds between the two operations.

NOTE

- Do not use an extension cable when connecting a USB device.

● Using USB flash drives

By connecting the instrument to a USB flash drive, you can save data you've created to the connected device, as well as read data from the connected device.

● Number of USB flash drives that can be used

Only one USB flash drive can be connected to each of the [USB TO DEVICE] terminals.

● Formatting a USB flash drive

You should format the USB flash drive only with this instrument (page 112). A USB flash drive formatted on another device may not operate properly.

NOTICE

The format operation overwrites any previously existing data. Make sure that the device you are formatting does not contain important data. Proceed with caution, especially when connecting multiple USB flash drives.

● To protect your data (write-protect)

To prevent important data from being inadvertently erased, apply the write-protect provided with each USB flash drive. If you are saving data to the device, make sure to disable write-protect.

● Turning off the instrument

When turning off the instrument, make sure that the instrument is NOT accessing the USB flash drive by playback/recording or file management (such as during Save, Copy, Delete and Format operations). Failure to do so may corrupt the device and the data.

Formatting a USB flash drive or the internal User drive

To format a USB flash drive or the internal User drive, execute the Format operation. In order to format a USB flash drive, make sure that a USB flash drive is properly connected to the [USB TO DEVICE] terminal beforehand.

- 1 Connect a USB flash drive for formatting to the [USB TO DEVICE] terminal.
- 2 Call up the operation display via [MENU] → [Utility] → [Storage].

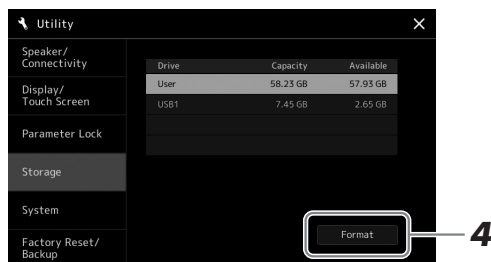

- 3 Touch the name of the desired drive to be formatted in the device list.

The indications USB 1, USB 2, etc. are displayed, depending on the number assigned to the connected device.

- 4 Touch [Format] to execute the Format operation.

Connecting to an iPhone/iPad (Wireless LAN function, [USB TO HOST], or MIDI terminals)

You can use a smart device, such as an iPhone or iPad, with the instrument for a variety of musical purposes by connecting it to the instrument. By using application tools on your smart device, you can take advantage of convenient functions and get more enjoyment out of this instrument.

You can make connections by one of the following methods.

- Connecting via the wireless LAN function (*1).
- Connect to the [USB TO HOST] terminal via a Wireless MIDI Adaptor: UD-BT01 (*2)
- Connect to the MIDI terminals via a Wireless MIDI Adaptor: MD-BT01 (*2)

*1 The wireless LAN function may not be included depending on your area.

*2 These accessories are sold separately, but may not be available depending on your area.

For details on connections, refer to the “iPhone/iPad Connection Manual” and the Reference Manual on the website.

For information about the compatible smart devices and application tools, access the following page:

<https://www.yamaha.com/kbdapps/>

NOTICE

The Format operation deletes any previously existing data. Make sure that the USB flash drive you are formatting does not contain important data. Proceed with caution, especially when connecting multiple USB flash drives.

NOTICE

Do not place your iPhone/iPad in an unstable position. Doing so may cause the device to fall and result in damage.

NOTE

When you use the instrument along with an application on your iPhone/iPad, we recommend that you first set “Airplane Mode” to “ON” then set “Wi-Fi” to “ON” on your iPhone/iPad in order to avoid noise caused by communication.

Connecting to a Computer ([USB TO HOST] terminal)

By connecting a computer to the [USB TO HOST] terminal, you can transfer data between the instrument and the computer via MIDI. For details on using a computer with this instrument, refer to the “Computer-related Operations” on the website.

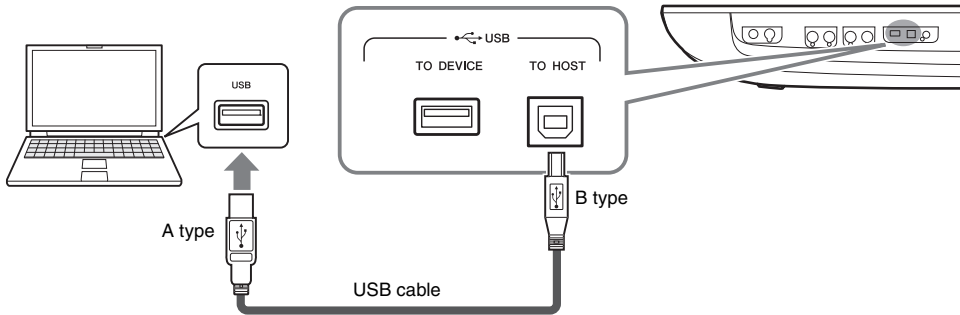

NOTICE

Use an AB type USB cable of less than 3 meters. USB 3.0 cables cannot be used.

NOTE

- When using a USB cable to connect the instrument to your computer, make the connection directly without passing through a USB hub.
- The instrument will begin transmission a short time after the USB connection is made.
- For information on setting up your sequence software, refer to the owner's manual of the relevant software.

Connecting External MIDI Devices (MIDI terminals)

Use the [MIDI] terminals and standard MIDI cables to connect external MIDI devices (keyboard, sequencer, etc.).

- **MIDI IN**.....Receives MIDI messages from another MIDI device. Two ports (A, B) are provided and each can receive MIDI messages over 16 channels.
- **MIDI OUT**Transmits MIDI messages generated by Genos to another MIDI device. Two ports (A, B) are provided and each can transmit MIDI messages over 16 channels.

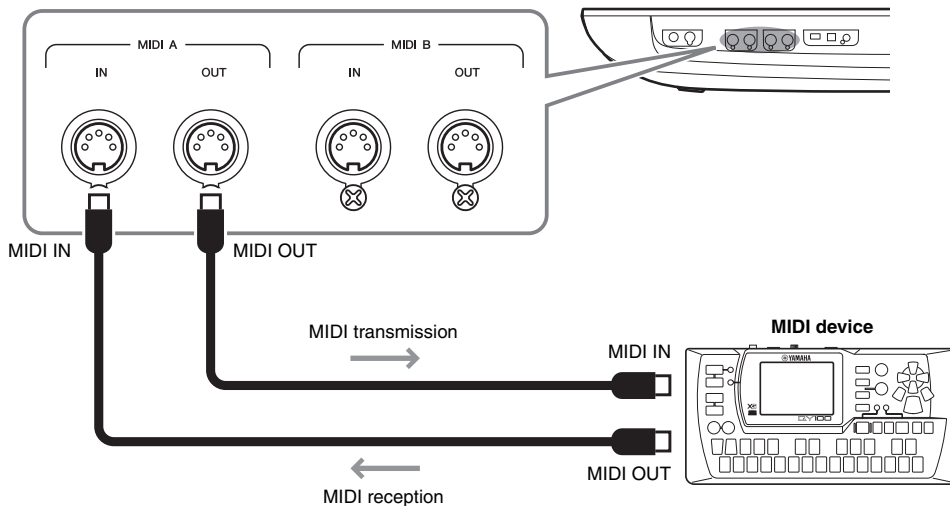

The MIDI settings such as transmit/receive channels on the instrument can be set via [MENU] → [MIDI]. For details, refer to the Reference Manual on the website.

NOTE

For a general overview of MIDI and how you can effectively use it, refer to “MIDI Basics,” which is downloadable from the website.

Function List

This section simply and very briefly explains what you can do in the displays called up by pressing the buttons on the panel, or by touching each icon on the Menu display.

For more information, refer to the page indicated below or the Reference manual on the website.

The “●” mark indicates that the detailed information is described in the Reference Manual.

Displays accessible by the panel buttons

| Display | Button to access | Description | Pages | Reference Manual |
|------------------------------------|-------------------------------|---|--------|------------------|
| Home | [HOME] | Portal of the instrument's display structure, which provides at-a-glance information on all current settings. | 30 | - |
| Menu | [MENU] | By touching each of the icons, you can call up the menus for the various functions listed below. | 33 | - |
| Style Selection | [STYLE] | For selecting Style files. | 44 | - |
| Voice Part Setup | [VOICE] | For making detailed settings such as Voice Edit and Effect settings of the keyboard parts. | - | ● |
| Song Playback | [SONG] | For controlling Song playback. | 72, 78 | ● |
| Playlist | [PLAYLIST] | For selecting and editing Playlists, and managing your repertoire. | 96 | - |
| Song Recording | [RECORDING] | For recording your performance. | 90 | ● |
| Voice Selection | VOICE SELECT [LEFT]-[RIGHT 3] | For assigning Voices to each of the keyboard parts. | 52 | ● |
| Multi Pad Selection | MULTI PAD CONTROL [SELECT] | For selecting Multi Pads. | 59 | ● |
| Registration Memory Bank Selection | REGISTRATION BANK [-]/[+] | For selecting Registration Memory Banks. | 94 | ● |
| Registration Memory window | [MEMORY] | For registering the current panel settings. | 93 | - |

Menu display functions

| Menu | Description | Pages | Reference Manual |
|-------------------|---|------------|------------------|
| Mixer | For adjusting the parameters of each part, such as volume, pan, and EQ. It also allows you to adjust overall sound controls, such as Master Compressor and Master EQ. | 86 | ● |
| Channel On/Off | For turning on and off the each channel of the Style, and MIDI Song. | - | ● |
| Line Out | Determines which jack is used to output each part and each drum & percussion instrument. | - | ● |
| Score | For displaying the music notation (score) of the current MIDI Song. | 83 | ● |
| Lyrics | For displaying the lyrics of the current Song. | 84 | ● |
| Text Viewer | For displaying text files created on your computer. | - | ● |
| Mic Setting | Makes settings for the microphone sound. | 107 | ● |
| Vocal Harmony | For adding Vocal Harmony effects to your singing. You can edit the Vocal Harmony and save as your original harmony. | 76 | ● |
| Kbd Harmony/Arp | For adding the Harmony/Arpeggio effect to the right-hand section of the keyboard. Parameters such as Harmony/Arpeggio type can be set. | 56 | ● |
| Split & Fingering | For setting the Split Point or change the Chord Fingering type and Chord Detection area. | 46, 49, 51 | ● |
| Regist Sequence | Determines the order for calling up Registration Memory settings when using the pedal. | - | ● |
| Regist Freeze | Determines the item(s) that remain unchanged even when you call up panel setups from the Registration Memory. | - | ● |
| Tempo | For adjusting the tempo of MIDI Song, Style or Metronome. The same operation as using Tempo [-]/[+] and [TAP TEMPO] buttons can be done on the display. | 46 | ● |
| Metronome | For making settings of the metronome and the [TAP TEMPO] button. | 41 | ● |
| Live Control | Determines the functions assigned to the LIVE CONTROL knobs & sliders. | 62 | ● |
| Assignable | Determines the functions assigned to the pedals, assignable buttons, and the shortcuts on the Home display. | 63, 100 | ● |

| Menu | Description | Pages | Reference Manual |
|--------------------------|--|-------|------------------|
| Panel Lock | For locking the panel settings. When the panel settings are locked, nothing happens even when pressing any panel buttons. | 41 | - |
| Demo | For calling up the Demo display. | 36 | - |
| Voice Edit | For editing the preset Voices to create your own Voices. The display differs depending on whether an Organ Flutes Voice or another kind of Voice is selected. | - | ● |
| Style Creator | For creating a Style by editing the preset Style, or by recording Style channels one by one. | - | ● |
| Song Recording | For recording your performance. (This is same as the [RECORDING] button on the panel.) | 90 | ● |
| M.Pad Creator | For creating a Multi Pad by editing an existing preset Multi Pad, or by recording a new one. | - | ● |
| Voice Setting | Determines the detailed settings of the keyboard parts, such as the pitch for each part, Voice Set filter, and Super Articulation Voice related settings. | - | ● |
| Style Setting | For making Style playback related settings such as OTS Link timing, Dynamics Control, etc. | - | ● |
| Song Setting | For making Song playback related settings such as Guide function, Channel settings, etc. | - | ● |
| Chord Tutor | Indicates how to play chords that correspond to the specified chord names. | - | ● |
| Tuning | For fine-tuning the pitch of the entire instrument, and setting the scale type. | - | ● |
| Transpose | For transposing the pitch of the entire sound in semitones, or just the sound of the keyboard or MIDI Song. | 61 | ● |
| Keyboard/Joystick | Determines the Touch Response of the keyboard and Joystick-related settings. | - | ● |
| Expansion | For installing Expansion Packs for adding extra contents downloaded from the website or created on your own by using the Yamaha Expansion Manager. | - | ● |
| MIDI | For making MIDI-related settings. | - | ● |
| Utility | For making global settings, managing the USB flash drives, initializing the instrument to the factory default, or backing up the data stored in the instrument, etc. | 101 | ● |
| Time | For making settings of the time shown on the display. | - | ● |
| Wireless LAN* | For making settings for connecting the instrument to a smart device such as iPad via the wireless LAN function. | - | ● |

* This icon appears only when the wireless function is included.

Installing the Optional Speakers

Make sure that all of the parts below have been included in the GNS-MS01 speaker package.

NOTICE

Use only the supplied cables.

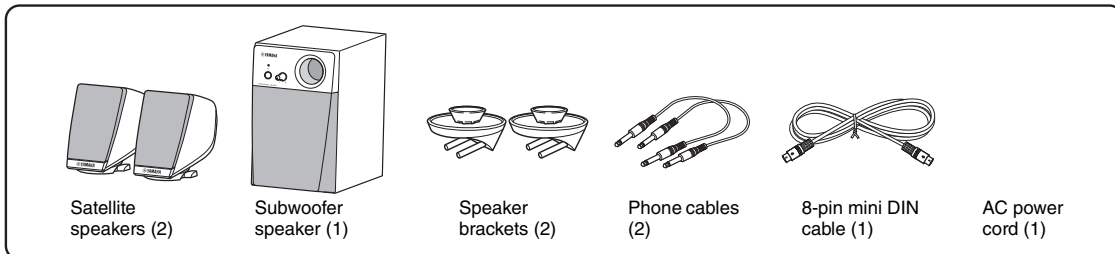

1 Turn Genos's power off, and disconnect the AC power cord. Also, make sure to disconnect the keyboard from any other external devices.

2 Insert the two speaker brackets to the rear panel of Genos.

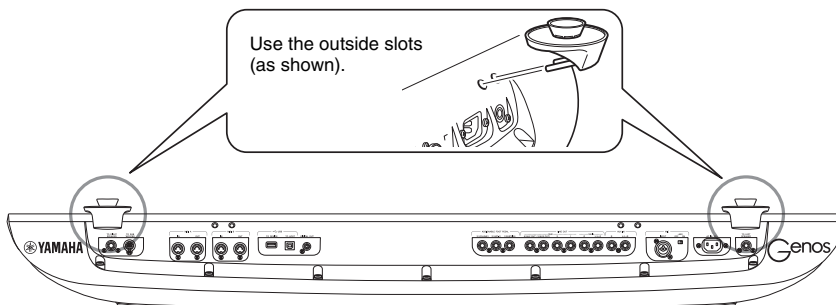

NOTE

Either bracket can be inserted interchangeably to either location.

3 Fasten the satellite speakers to the left and right brackets.

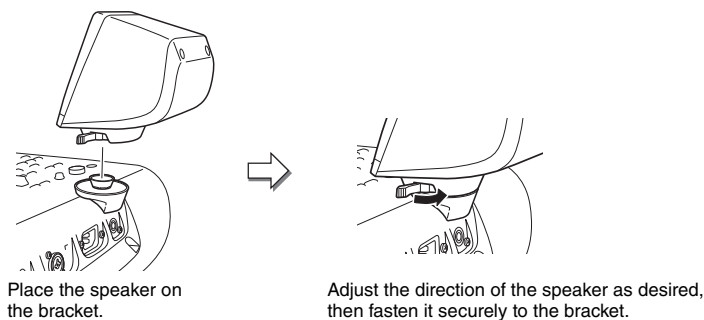

NOTE

The satellite speakers can be installed interchangeably to either location.

4 Use the phone cables to connect the speakers to the respective outputs on Genos.

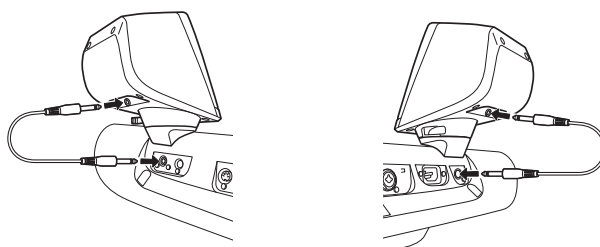

Either cable can be used interchangeably with either output jack.

- 5** Use the 8-pin mini DIN cable to connect the subwoofer to Genos.

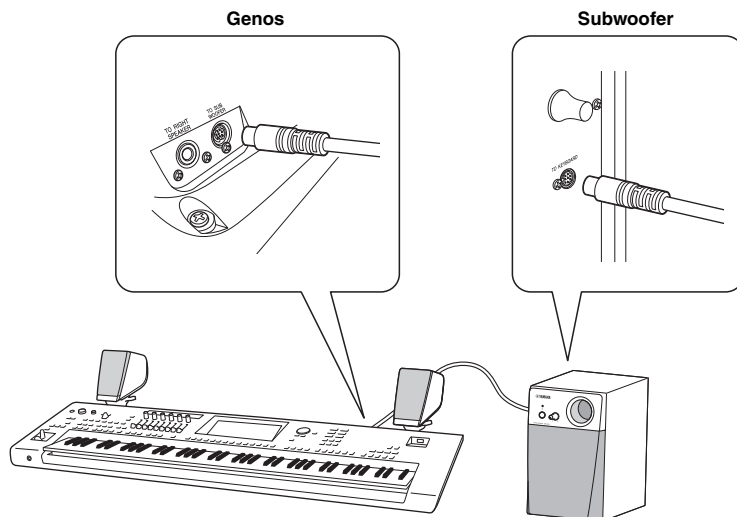

- 6** Connect the supplied AC power cord to the subwoofer.
- 7** Connect the power plugs of Genos and the subwoofer to an appropriate AC outlet.
- 8** Set the volume controls (**MASTER VOLUME** on Genos and **MAIN VOLUME** on the subwoofer) to minimum.

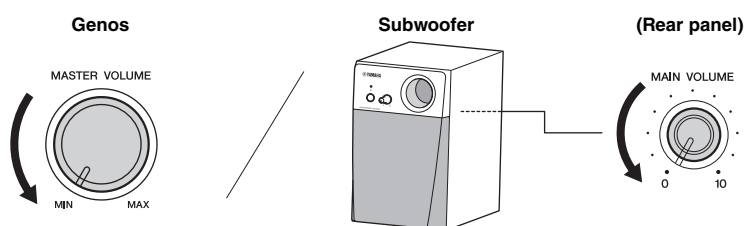

- 9** Turn on the power of Genos, then the subwoofer.

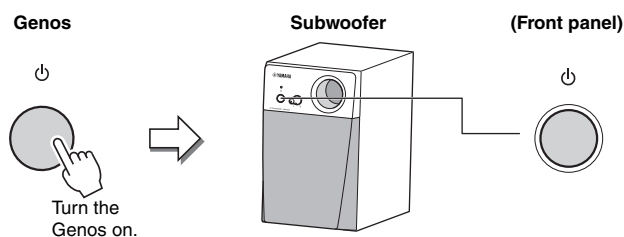

- 10** Adjust the volume controls (**MASTER VOLUME** on Genos and **MAIN VOLUME** on the subwoofer) to appropriate levels.

Direct Access Chart

Press the [DIRECT ACCESS] button, then press one of the buttons (or move the appropriate knob, slider, joystick or pedal) listed below to call up the desired display.

| Control | | Display called up with the Direct Access function | | | | | |
|----------------------|----------------|---|-------------------|-------------------------|---------|---|--------------------------|
| STYLE | ACMP | Menu | Mixer | Split Point & Fingering | - | - | - |
| | AUTO FILL IN | | | Style Setting | Setting | - | - |
| | OTS LINK | | | Effect | Style | - | - |
| | BREAK | | | Pan Volume | Style | - | - |
| | INTRO 1 | | | Filter | Style | - | - |
| | INTRO 2 | | | Chorus Reverb | Style | - | - |
| | INTRO 3 | | | EQ | Style | - | - |
| | MAIN A | | | Compressor | Master | - | - |
| | MAIN B | | | Split Point & Fingering | - | - | - |
| | MAIN C | | | Style Setting | Setting | - | - |
| | MAIN D | | | | | | |
| | ENDING 1 | | | | | | |
| | ENDING 2 | | | | | | |
| | ENDING 3 | | | | | | |
| | SYNC START | | | | | | |
| SYNC STOP | | | | | | | |
| START/STOP | | | | | | | |
| SONG A | PLAY/PAUSE | Menu | Song Setting | Play | - | - | - |
| | PREV | | | | | | |
| | NEXT | | | | | | |
| SONG B | PLAY/PAUSE | | | | | | |
| | PREV | | | | | | |
| SONG A/SONG B | NEXT | | | | | | |
| RECORDING | CROSS FADER | | | | | | |
| | | | | | | | |
| TIMING | TAP TEMPO | Menu | Metronome | Tap Tempo | - | - | - |
| | TEMPO + | Menu | Style Setting | - | - | - | - |
| | TEMPO - | | | | | | |
| TRANSPOSE | TRANSPOSE + | Menu | Transpose | - | - | - | - |
| | TRANSPOSE - | | | | | | |
| UPPER OCTAVE | UPPER OCTAVE + | Menu | Voice Setting | Tune | - | - | - |
| | UPPER OCTAVE - | | | | | | |
| ROTARY SP/ASSIGNABLE | | Menu | Assignable | - | - | - | Rotary Sp/ Assignable |
| MIC | VOCAL HARMONY | Menu | Vocal Harmony | - | - | - | - |
| | TALK | | Mic Setting | - | - | - | - |
| DIRECT ACCESS | | - | - | - | - | - | - |
| ART | 1 | Menu | Assignable | - | - | - | Pedal 1 |
| | 2 | | | | | | Pedal 2 |
| | 3 | | | | | | Pedal 3 |
| MODULATION HOLD | | - | - | - | - | - | - |
| JOYSTICK | JOYSTICK X | Menu | Keyboard/Joystick | Joystick | - | - | - |
| | JOYSTICK Y | | Keyboard/Joystick | Joystick | - | - | - |
| KNOB | 1 | Menu | Live Control | - | - | - | Knob 1 |
| | 2 | | | | | | Knob 2 |
| | 3 | | | | | | Knob 3 |
| | 4 | | | | | | Knob 4 |
| | 5 | | | | | | Knob 5 |
| | 6 | | | | | | Knob 6 |
| | ASSIGN | | | | | | Knob 1 |
| SLIDER | 1 | Menu | Live Control | - | - | - | Slider 1 |
| | 2 | | | | | | Slider 2 |
| | 3 | | | | | | Slider 3 |
| | 4 | | | | | | Slider 4 |
| | 5 | | | | | | Slider 5 |
| | 6 | | | | | | Slider 6 |
| | 7 | | | | | | Slider 7 |
| | 8 | | | | | | Slider 8 |
| | 9 | | | | | | Slider 9 |
| | ASSIGN | | | | | | Slider 1 |
| ONE TOUCH SETTING | 1 | (Style Selection) | - | - | - | - | Style Information |
| | 2 | | | | | | |
| | 3 | | | | | | |
| | 4 | | | | | | |

| Control | | Display called up with the Direct Access function | | | | | | | |
|-----------------------|-----------------------------|---|------------------------|------------------|-------------------------------|--------------|---------------|-------|---|
| MULTI PAD | MULTI PAD SELECT | (Multi Pad Selection) | - | - | Multi Pad Edit | Multi Pad 1 | | | |
| | STOP | | | | | Multi Pad 1 | | | |
| | 1 | (Multi Pad Selection) | - | - | Multi Pad Edit | Multi Pad 1 | | | |
| | 2 | | | | | Multi Pad 2 | | | |
| | 3 | | | | | Multi Pad 3 | | | |
| 4 | Multi Pad 4 | | | | | | | | |
| ENTER | | - | - | - | - | | | | |
| EXIT | | Home | - | - | - | - | | | |
| DIAL | | - | - | - | - | - | | | |
| INC | | - | - | - | - | - | | | |
| DEC | | - | - | - | - | - | | | |
| VOICE | PART SELECT LEFT | Menu | Voice Setting | Voice Set Filter | LEFT | - | | | |
| | PART SELECT R1 | | | | R1 | | | | |
| | PART SELECT R2 | | | | R2 | | | | |
| | PART SELECT R3 | | | | R3 | | | | |
| | PART ON/OFF LEFT | | | | LEFT | | | | |
| | PART ON/OFF R1 | | | | R1 | | | | |
| | PART ON/OFF R2 | | | | R2 | | | | |
| | PART ON/OFF R3 | | | | R3 | | | | |
| | LEFT HOLD | | | | Split Point & Fingering | | - | - | - |
| | SUSTAIN | | | | Mixer | | Chorus Reverb | Panel | - |
| HARMONY/ARPEGGIO | Keyboard Harmony / Arpeggio | - | - | - | | | | | |
| HOME | | - | - | - | - | | | | |
| MENU | | - | - | - | - | | | | |
| STYLE | | - | - | - | - | | | | |
| VOICE | | - | - | - | - | | | | |
| SONG | | - | - | - | - | | | | |
| PLAYLIST | | - | - | - | - | | | | |
| ASSIGNABLE | A | Menu | Assignable | - | - | Assignable A | | | |
| | B | | | | | Assignable B | | | |
| | C | | | | | Assignable C | | | |
| | D | | | | | Assignable D | | | |
| | E | | | | | Assignable E | | | |
| | F | | | | | Assignable F | | | |
| REGISTRATION MEMORY | REGIST BANK + | Menu | Registration Bank Edit | - | - | - | | | |
| | REGIST BANK - | | Registration Bank Edit | - | - | - | | | |
| | FREEZE | | Registration Freeze | - | - | - | | | |
| | MEMORY | | Registration Sequence | - | - | - | | | |
| | 1 | (Registration Bank Selection) | - | - | Registration Bank Information | - | | | |
| | 2 | | | | | | | | |
| | 3 | | | | | | | | |
| | 4 | | | | | | | | |
| | 5 | | | | | | | | |
| | 6 | | | | | | | | |
| 7 | | | | | | | | | |
| 8 | | | | | | | | | |
| 9 | | | | | | | | | |
| 10 | | | | | | | | | |
| ASSIGNABLE FOOT PEDAL | 1 | Menu | Assignable | - | - | Pedal 1 | | | |
| | 2 | | | | | Pedal 2 | | | |
| | 3 | | | | | Pedal 3 | | | |

Troubleshooting

| Overall | |
|--|---|
| A click or pop is heard when the power is turned on or off. | This is normal. Electrical current is being applied to the instrument. |
| The power is automatically turned off. | This is normal and due to the Auto Power Off function. If necessary, set the parameter of the Auto Power Off function (page 24). |
| Noise is heard from the instrument. | Noise may be heard if a mobile phone is used near the instrument or if the phone is ringing. Turn off the mobile phone, or use it further away from the instrument. |
| Noise is heard from the instrument's speakers or headphones when using the instrument with an iPhone/iPad app. | When you use the instrument along with an iPhone/iPad app, we recommend that you set "Airplane Mode" to "ON" on your iPhone/iPad in order to avoid noise caused by communication. |
| In the LCD, there are some specific points that are always lit or unlit. | These are the result of defective pixels and occasionally occur in TFT-LCDs; they do not indicate a problem in operation. |
| There is a slight difference in sound quality among different notes played on the keyboard. | This is normal and is a result of the instrument's sampling system. |
| Some Voices have a looping sound. | |
| Some noise or vibrato is noticeable at higher pitches, depending upon the Voice. | |
| The overall volume is too low, or, no sound is heard. | The master volume may be set too low. Set it to an appropriate level with the [MASTER VOLUME] dial. |
| | All keyboard parts are set to off. Use the PART ON/OFF [RIGHT 1]/[RIGHT 2]/[RIGHT 3]/[LEFT] button to turn it on (page 48). |
| | The volume of individual parts may be set too low. Raise the volume in the Mixer display (page 86). |
| | Make sure the desired channel is set to on in the Mixer display (page 88). |
| | Headphones are connected, disabling the speaker output. Unplug the headphones. |
| | Connect the footswitch to the appropriate jack. |
| The sound is distorted or noisy. | Check whether the external speaker is connected and the volume control is adjusted properly (pages 108, 116). |
| | The volume may be turned up too high. Make sure all relevant volume settings are appropriate. |
| Not all simultaneously played notes sound. | This may be caused by certain effects or filter resonance settings. Check the effect or filter settings and change them accordingly in the Mixer display, referring to the Reference Manual on the website. |
| | You are probably exceeding the maximum polyphony of the instrument. When the maximum polyphony is exceeded, the least important notes (such as soft notes and notes currently decaying) will stop sounding first. |
| The keyboard volume is lower than the Style/Song playback volume. | The volume of the keyboard parts may be set too low. Raise the volume in the Mixer display (page 86). |
| The Main display does not appear even when turning the power on. | This may occur if a USB flash drive has been installed to the instrument. Installation of some USB flash drive may result a long interval between turning the power on and appearance of the Home display. To avoid this, turn the power on after disconnecting the device. |
| Some characters of the file/folder name are garbled. | The language settings have been changed. Set the appropriate language for the file/folder names (page 24). |
| An existing file is not shown. | The file extension (.MID, etc.) may have been changed or deleted. Manually rename the file, adding the appropriate extension, on a computer. |
| | Data files with names of more than 50 characters cannot be handled by the instrument. Rename the file, reducing the number of characters to 50 or less. |
| Style | |
| The Style does not start even when the [START/STOP] button is pressed. | The Rhythm channel of the selected Style may not contain any data. Turn the [ACMP] button on and play the left-hand section on the keyboard to sound the accompaniment part of the Style. |

| | |
|---|---|
| Only the rhythm channel plays. | Make sure the Auto Accompaniment function is turned on; press the [ACMP] button. |
| | Make sure to play keys in the chord range of the keyboard. |
| Styles in a USB flash drive cannot be selected. | If the size of the Style data is large (about 120 KB or greater), the Style cannot be selected because the data is too large to be read by the instrument. |
| Style playback seems to “skip” when the keyboard is played. | You are probably exceeding the maximum polyphony of the instrument. The instrument can play up to 256 notes at the same time—including RIGHT 1/RIGHT 2/RIGHT 3/ LEFT Voices, Style, Song, and Multi Pad notes. When the maximum polyphony is exceeded, the least important notes (such as soft notes and notes currently decaying) will stop sounding first. |
| Style does not change even when a different chord is played, or the chord is not recognized. | Make sure to play notes on the left-hand section of the keyboard. |
| Voice | |
| The Voice selected from the Voice Selection display does not sound. | Check whether the selected part is turned on or not (page 48). |
| A strange “flanging” or “doubling” sound occurs. The sound is slightly different each time the keys are played. | The RIGHT 1 and RIGHT 2 parts are set to “ON,” and both parts are set to play the same Voice. Turn off the RIGHT 2 part or change the Voice of one of the parts. |
| The sound is slightly different each time the keys are played. | If you are routing the MIDI OUT on the Genos to a sequencer and back to the MIDI IN, you may need to set Local Control setting to “off” in the System page of the MIDI display (refer to the Reference Manual on the website). |
| Some Voices will jump an octave in pitch when played in the upper or lower registers. | This is normal. Some voices have a pitch limit which, when reached, causes this type of pitch shift. |
| Song | |
| MIDI Songs cannot be selected. | If the size of the Song data is large (about 300 KB or greater), the Song cannot be selected because the data is too large to be read by the instrument. |
| | In the Dual Player mode, two MIDI Songs cannot be selected for SONG A and SONG B. Select Audio Song for either side. |
| | MIDI Songs cannot be played back during MIDI recording operation. Stop MIDI Recording when you want to play back a MIDI Song. |
| Audio Songs cannot be selected. | The file format may not be compatible with the instrument. Compatible formats are: MP3 and WAV. DRM protected files cannot be played back. |
| The sound of a song is too low, or a song cannot be heard. | Check the position of the Cross Fader. If the Cross Fader is set to the right position, you cannot hear the song of SONG A side. If this is the case, adjust the Cross Fader to the center position. |
| Song playback does not start. | The Song has been stopped at the end of the Song data. Return to the beginning of the Song by pressing the SONG [PREV] button. |
| The Song playback volume differs depending on the selected song. | The volume of MIDI Songs and Audio Songs are set independently. Adjust the volume in the Mixer display (page 86) after selecting a Voice. |
| (MIDI) The measure number is different from that of the score in the Song Position display, shown by pressing and holding the [PREV]/[NEXT] buttons. | This happens when playing back music data for which a specific, fixed tempo is set. |
| (MIDI) When playing back a Song, some channels do not play. | Playback of these channels may be set to off. Turn playback on for those channels that are set to off (page 88). |
| (MIDI) The tempo, beat, measure and music notation are not displayed correctly. | Some Song data for the instrument has been recorded with special “free tempo” settings. For such Song data, the tempo, beat, measure and music notation will not be displayed correctly. |
| (Audio) Recorded file is played back at a different volume compared to when it was recorded. | The audio playback volume has been changed. Setting the volume value to 90 plays back the file at the same volume as when it was recorded (page 86). |
| In the Audio Recording function, an error message appears and audio cannot be recorded to the internal User drive. | The data on the User drive is fragmented and cannot be used as is. Since there is no defragmentation function in the Audio Recording, the drive can only be defragmented by formatting it. To do this, first back up the data by using the data backup function (page 105), then format the drive, and finally restore the backup data. Performing this backup/restore operation effectively defragments the drive, allowing you to use it again. |

| Mixer | |
|---|--|
| The sound seems strange or different than expected when changing a rhythm Voice (drum kit, etc.) of the Style or Song from the Mixer. | When changing the rhythm/percussion Voices (drum kits, etc.) of the Style and Song from the VOICE parameter, the detailed settings related to the drum voice are reset, and in some cases you may be unable to restore the original sound. You can restore the original sound by selecting the same Song or Style again. |
| Microphone/Vocal Harmony | |
| The microphone input signal cannot be recorded. | The microphone input signal cannot be recorded by MIDI recording. Record by using Audio recording (page 91). |
| Harmony can be heard in addition to the microphone sound. | Vocal Harmony is set to on. Turn Vocal Harmony off (page 85). |
| The Vocal Harmony effect sounds distorted or out-of-tune. | Your vocal microphone may be picking up extraneous sounds, such as the Style sound from the instrument. In particular, bass sounds can cause mistracking of the Vocal Harmony. To remedy this: <ul style="list-style-type: none"> • Sing as closely to the microphone as possible. • Use a directional microphone. • Turn down the Master volume, Style volume, or Song volume control (pages 23, 86). • Separate the microphone from the external speakers as far as possible. |
| The Vocal Harmony effect is not applied even when it is turned on. | In the Chordal mode, Vocal Harmony is added only when chords are detected. Try one of the following: <ul style="list-style-type: none"> • Turn on the [ACMP ON/OFF] button and play chords in the chord section during Style playback. • Turn on the Left part and play chords in the left hand section. • Play back a Song which contains chords. • Set the "Stop ACMP" parameter to something other than "Disabled" via [MENU] → [Style Setting] → [Setting]. For details, refer to the Reference Manual on the website. |
| ASSIGNABLE FOOT PEDAL jacks | |
| The on/off setting of the footswitch connected to the ASSIGNABLE FOOT PEDAL jack is reversed. | Turn the instrument's power off, then turn it on again making sure not to press the footswitch. |
| AUX IN jacks | |
| Sound input to the AUX IN jacks is interrupted. | The output volume of the external device connected to this instrument is too low. Increase the output volume of the external device. The volume level reproduced via this instrument can be adjusted by using the [MASTER VOLUME] dial. |

Specifications

| | | | | |
|--------------------------|---------------------------|--|---|--|
| Product Name | | Digital Keyboard | | |
| Size/Weight | Dimensions (W x D x H) | | 1234 mm x 456 mm x 138 mm (48-9/16" x 17-15/16" x 5-7/16") | |
| | Weight | | 13.0kg (28 lbs., 11 oz.) | |
| Control Interface | Keyboard | Number of Keys | 76 | |
| | | Type | Organ (FSX), Initial Touch/Aftertouch | |
| | | Touch Response | Normal, Easy1, Easy2, Soft1, Soft2, Hard1, Hard2 | |
| | Other Controllers | Joystick | Yes | |
| | | Knobs | 6 (Assignable) | |
| | | Sliders | 9 (Assignable), Cross Fader | |
| | | Articulation Switches | ART. 1, ART. 2, ART. 3 | |
| | Main Display | Type | TFT Color Wide VGA LCD | |
| | | Size | 800 x 480 dots 9 inch | |
| | | Touch Screen | Yes | |
| | | Language | English, German, French, Spanish, Italian | |
| Sub Display | Type | OLED (LIVE CONTROL View) | | |
| | Size | 589 x 48 dots | | |
| | Language | English | | |
| Panel | Language | English | | |
| Voices | Tone Generation | Tone Generation Technology | AWM Stereo Sampling, AEM technology | |
| | Polyphony | | 256 (max.) (128 for Preset Voices + 128 for Expansion Voices) | |
| | Preset | Number of Voices | 1,652 Voices + 58 Drum/SFX Kits | |
| | | Featured Voices | 10 Revo! Drums/SFX, 76 Ensemble, 390 Super Articulation!, 75 Super Articulation2!, 82 MegaVoice, 40 Sweet!, 81 Cool!, 160 Live!, 24 Organ Flutes! | |
| | Compatibility | | XG, GS, GM, GM2 (for Song playback) | |
| | Part | | Right 1, Right 2, Right 3, Left | |
| Effects | Reverb | | 59 Preset + 3 User | |
| | Chorus | | 107 Preset + 3 User | |
| | DSP | | Variation: 358 Preset(with VCM) + 3 User Insertion 1-28: 358 Preset(with VCM) + 10 User | |
| | Master Compressor | | 5 Preset + 5 User | |
| | Master EQ | | 5 Preset + 2 User | |
| | Part EQ | | 28 Parts | |
| | Vocal Harmony | | 54 Preset + 60 User (*) * The User number represents the total of Vocal Harmony and Synth Vocoder. | |
| | Synth Vocoder | | 20 Preset + 60 User (*) * The User number represents the total of Vocal Harmony and Synth Vocoder. | |
| | Others | | Mic Effect: Noise Gate, Compressor, 3 Band EQ Vocal Effect: 23 | |
| Styles | Preset | Number of Styles | 550 | |
| | | Featured Styles | 491 Pro, 39 Session, 10 Free Play, 10 DJ | |
| | | Fingering | Single Finger, Fingered, Fingered On Bass, Multi Finger, AI Fingered, Full Keyboard, AI Full Keyboard | |
| | | Style Control | INTRO x 3, MAIN VARIATION x 4, FILL x 4, BREAK, ENDING x 3 | |
| | Other Features | One Touch Setting (OTS) | 4 for each Style | |
| Compatibility | | Style File Format (SFF), Style File Format GE (SFF GE) | | |
| Expandability | Expansion Voice | | Yes (approx. 1.8 GB) | |
| | Expansion Style | | Yes (Internal Memory) | |
| | Expansion Audio Style | | Yes (Internal Memory) | |
| Songs (MIDI) | Preset | Number of Preset Songs | 9 Demo Songs, 11 Preset Songs | |
| | Recording | Number of Tracks | 16 | |
| | | Data Capacity | approx. 300 KB per Song | |
| | | Function | Quick Recording, Multi Track Recording, Step Recording | |
| | Format | Playback | SMF (Format 0, Format 1), XF | |
| Recording | | SMF (Format 0) | | |
| Songs (Audio) | Recording | Data Capacity | approx. 0.8 GB (80 minutes) per Song | |
| | Format | Playback | WAV (44.1kHz, 16bit, stereo), MP3 (44.1kHz, 64/96/128/256/320kbps, stereo) | |
| | | Recording | WAV (44.1kHz, 16bit, stereo) | |
| | | Playback (Multi) | .aud (Genos original: 44.1 kHz sample rate, 16 bit resolution, stereo) | |
| | | Recording (Multi) | .aud (Genos original: 44.1 kHz sample rate, 16 bit resolution, stereo) | |
| | Time Stretch | | Yes | |
| | Pitch Shift | | Yes | |
| | Vocal Cancel | | Yes | |
| Multi Pads | Number of Multi Pad Banks | | 448 Banks x 4 Pads | |
| | Audio Link | | Yes | |

| | | | |
|--|-------------------------|--|---|
| Functions | Voices | Harmony | Yes |
| | | Arpeggio | Yes |
| | | Panel Sustain | Yes |
| | | Mono/Poly | Yes |
| | Styles | Style Creator | Yes |
| | | OTS Information | Yes |
| | Songs | Score Display Function | Yes |
| | | Lyrics Display Function | Yes |
| | | Lesson/Guide | Follow Lights, Any Key, Karao-Key, Your Tempo |
| | Multi Pads | Multi Pad Creator | Yes |
| | Registration Memory | Number of Buttons | 10 |
| | | Control | Registration Sequence, Freeze |
| | Playlist | Number of Records | 2,500 (max.) Records per Playlist file |
| | Search | | Yes |
| | Demo | | Yes |
| | Overall Controls | Metronome | Yes |
| | | Tempo Range | 5 – 500, Tap Tempo |
| | | Transpose | -12 – 0 – +12 |
| | | Tuning | 414.8 – 440.0 – 466.8 Hz (approx. 0.2Hz increments) |
| | | Octave Button | Yes |
| | Miscellaneous | Scale Type | 9 Types |
| | | Direct Access | Yes |
| | | Text/Image Display Function | Yes |
| | Wallpaper Customization | Yes | |
| | | | |
| Storage and Connectivity | Storage | Internal Memory (User Drive) | Yes (approx. 58 GB) |
| | | External Drives | USB flash drive |
| | Connectivity | Headphones | Standard stereo phone jack (PHONES) |
| | | Microphone | Yes (Combo Jack), Phantom Power (+48V) available |
| | | MIDI | MIDI A (IN/OUT), MIDI B (IN/OUT) |
| | | AUX IN | L/L+R, R |
| | | LINE OUT | MAIN (L/L+R, R), SUB (1, 2), SUB (3, 4 / AUX OUT) |
| | | DIGITAL OUT (Audio) | Yes (coaxial) |
| | | FOOT PEDAL | 1 (SUSTAIN), 2 (ART.1), 3 (VOLUME), Function Assignable |
| | | USB TO DEVICE | Yes (x 3) |
| | | USB TO HOST | Yes |
| | Wireless LAN | Yes (*) | |
| | | <ul style="list-style-type: none"> • Standards: IEEE802.11b/g/n (IEEE802.11n 5GHz: not compatible) • Range of transmit frequency (channels): Models for United States and Canada: 2400–2472 MHz (Channels 1–11) Others: 2400–2483.5 MHz (Channels 1–13) • Maximum RF output power: 14 dBm • Security: WEP, WPA2-PSK(AES), WPA/WPA2 mixed PSK | |
| | | * May not be included, depending on your area. Check with your Yamaha dealer. | |
| | Power Supply | Auto Power Off | Yes |
| Included Accessories | | <ul style="list-style-type: none"> • Owner's Manual • Online Member Product Registration • AC Power Cord • Music Rest, two Music Rest Brackets | |
| Separately Sold Accessories (May not be available depending on your area.) | | <ul style="list-style-type: none"> • Option Speaker: GNS-MS01 • Headphones: HPH-50, HPH-100, HPH-150 • Footswitch: FC4A, FC5 • Foot Controller: FC7 • Wireless MIDI Adaptor: UD-BT01, MD-BT01 • Keyboard Stand: L-7B | |

* The contents of this manual apply to the latest specifications as of the publishing date. To obtain the latest manual, access the Yamaha website then download the manual file. Since specifications, equipment or separately sold accessories may not be the same in every locale, please check with your Yamaha dealer.

Index

- A**
- A-B Repeat 80
 - AC IN 23
 - Accessories 9
 - Accompaniment 44
 - Action (Playlist) 97
 - AI Full Keyboard 46
 - Arpeggio 57
 - ASSIGNABLE Buttons 100
 - Audio Link Multi Pad 59
 - Audio Song 72
 - Auto Power Off 24, 25
 - Auto Power Saving 24, 25
 - AUX IN 109
- B**
- Backup 105
 - Break (Style) 65
- C**
- Channel (Style, MIDI Song) 88
 - Character Entry 40
 - Chord Detection Area 51
 - Chord Fingering Type 46
 - Chord Match 70
 - Chordal 76
 - Chorus 87
 - Close 33
 - Compressor 102
 - Computer 113
 - Computer-related Operations 10
 - Connection 106
 - Copy 38
 - Cross Fader 85
- D**
- Data Dial 35
 - Data List 10
 - Delete 39
 - Demo 36
 - DIGITAL OUT 109
 - Direct Access 36, 118
 - Dual Player 16, 73, 78
- E**
- Effect 87
 - Ending (Style) 64
 - Ensemble Voice 54
 - EQ (for each part) 87
 - EQ (Master EQ) 102
 - Expansion Packs 103
- F**
- Factory Reset 104
 - Fade In/Out 65
 - Fast Forward 78
 - Favorite 32, 39
 - File 32
 - File Selection Display 32
 - Fill-in (Style) 65
 - Filter 87
 - Fingered 46
 - Fingering Type 46
 - Folder 38
 - Foot Controller 63, 110
 - Footage 53
 - Footswitch 63, 110
 - Format 112
- G**
- Gateway Buttons 28
- H**
- Harmony (Keyboard Harmony) 56
 - Harmony (Vocal Harmony) 76, 85
 - Headphones 22
 - Home Display 28, 30
- I**
- Intro (Style) 64
 - iPhone/iPad 112
 - iPhone/iPad Connection Manual 10
- J**
- Joystick 66
- K**
- Keyboard Harmony 56
 - Keyboard Part 16, 48
 - Knob Assign Type 27, 62
- L**
- Language 24
 - Layer 48
 - LED (Lighting Buttons) 25
 - Left Hold 49
 - Lighting Buttons 25, 26
 - LINE OUT 108
 - LIVE CONTROL knobs 62
 - LIVE CONTROL sliders 62
 - LIVE CONTROL view 26, 27
 - Loop Playback 82
- LOWER** 48
- Lower 51
- Lyrics 84
- M**
- Main (Style) 65
 - Main Display 26, 28
 - Manual Bass 51
 - Master Compressor 102
 - Master EQ 102
 - Menu 33, 114
 - Metronome 41
 - Mic Effect 16
 - Microphone 21, 85, 106
 - MIDI 112, 113
 - MIDI Song 72
 - Mixer 86
 - Modulation 66
 - MODULATION HOLD 66
 - Move 38
 - MP3 73
 - Multi Pad 16, 59, 70
 - Music Notation 83
 - Music Rest 20
- N**
- Next 78
- O**
- One Touch Setting 47, 60
 - Optional Speakers 116
 - Organ Flutes Voice 53
 - OTS Link 65
 - Owner Name 24
- P**
- Pan 87
 - Panel Lock 41
 - Parameter Lock 101
 - Phrase Mark 79
 - Pitch Bend 66
 - Pitch Shift 80
 - Play/Pause 78
 - Playback (Multi Pad) 70
 - Playback (Song) 78
 - Playback (Style) 64
 - Playlist 17, 92, 96
 - Playlist Record 96
 - Power 23
 - Preset 32
 - Previous 78

R

| | |
|--------------------------------|--------|
| Record Name (Playlist) | 97 |
| Recording..... | 17, 90 |
| Reference Manual..... | 10 |
| Registration Memory..... | 17, 92 |
| Registration Memory Bank..... | 31, 92 |
| Registration Sequence..... | 31 |
| Rename | 38 |
| Restore | 105 |
| Reverb | 87 |
| Revo Drum, Revo SFX Voice..... | 52 |
| Rewind | 78 |
| Rotary Sp/Assignable | 63 |

S

| | |
|------------------------------------|------------|
| S.Art, S.Art2 (Super Articulation) | |
| Voice..... | 52 |
| Save | 37 |
| Score..... | 83 |
| Search..... | 39 |
| Shortcut..... | 30, 100 |
| Slider Assign Type | 27, 62 |
| Song..... | 16, 72 |
| Song File Compatibility | 73 |
| Song List..... | 16, 73, 78 |
| Song Position Marker..... | 81 |
| Specifications..... | 123 |
| Split | 48 |
| Split Point..... | 49 |
| Style | 16, 44 |
| Super Articulation Voice..... | 67 |
| Sustain | 67 |
| Synchro Start (MIDI Song)..... | 79 |
| Synchro Start (Multi Pad)..... | 71 |
| Synchro Start (Style)..... | 64 |
| Synchro Stop (Style)..... | 64 |
| Synth Vocoder | 77 |

T

| | |
|-----------------------|-----|
| Talk | 85 |
| TAP TEMPO | 46 |
| TEMPO | 46 |
| Text | 84 |
| Time Stretch..... | 80 |
| Touch Screen..... | 34 |
| TRANSCOPE..... | 61 |
| Troubleshooting | 120 |
| Tuning | 61 |

U

| | |
|-----------------------|-----|
| UPPER..... | 48 |
| Upper | 51 |
| UPPER OCTAVE..... | 61 |
| USB Flash Drive | 111 |
| User | 32 |

V

| | |
|--------------------------------|------------|
| Vocal Cancel..... | 80 |
| Vocal Harmony | 76, 85 |
| Vocoder..... | 76 |
| Vocoder-mono | 76 |
| Voice | 16, 52, 89 |
| Voice Part Setup Display | 29 |
| Volume (for each part) | 87 |
| Volume (Master Volume) | 23 |

W

| | |
|--------------------|-----|
| WAV..... | 73 |
| Wireless LAN | 112 |

Memo

GNU GENERAL PUBLIC LICENSE

Version 2, June 1991

Copyright © 1989, 1991 Free Software Foundation, Inc., 51 Franklin Street, Fifth Floor, Boston, MA 02110-1301 USA
Everyone is permitted to copy and distribute verbatim copies of this license document, but changing it is not allowed.

Preamble

The licenses for most software are designed to take away your freedom to share and change it. By contrast, the GNU General Public License is intended to guarantee your freedom to share and change free software—to make sure the software is free for all its users. This General Public License applies to most of the Free Software Foundation's software and to any other program whose authors commit to using it. (Some other Free Software Foundation software is covered by the GNU Lesser General Public License instead.) You can apply it to your programs, too.

When we speak of free software, we are referring to freedom, not price. Our General Public Licenses are designed to make sure that you have the freedom to distribute copies of free software (and charge for this service if you wish), that you receive source code or can get it if you want it, that you can change the software or use pieces of it in new free programs; and that you know you can do these things.

To protect your rights, we need to make restrictions that forbid anyone to deny you these rights or to ask you to surrender the rights. These restrictions translate to certain responsibilities for you if you distribute copies of the software, or if you modify it.

For example, if you distribute copies of such a program, whether gratis or for a fee, you must give the recipients all the rights that you have. You must make sure that they, too, receive or can get the source code. And you must show them these terms so they know their rights.

We protect your rights with two steps: (1) copyright the software, and (2) offer you this license which gives you legal permission to copy, distribute and/or modify the software.

Also, for each author's protection and ours, we want to make certain that everyone understands that there is no warranty for this free software. If the software is modified by someone else and passed on, we want its recipients to know that what they have is not the original, so that any problems introduced by others will not reflect on the original authors' reputations.

Finally, any free program is threatened constantly by software patents. We wish to avoid the danger that redistributors of a free program will individually obtain patent licenses, in effect making the program proprietary. To prevent this, we have made it clear that any patent must be licensed for everyone's free use or not licensed at all.

The precise terms and conditions for copying, distribution and modification follow.

GNU GENERAL PUBLIC LICENSE TERMS AND CONDITIONS FOR COPYING, DISTRIBUTION AND MODIFICATION

0. This License applies to any program or other work which contains a notice placed by the copyright holder saying it may be distributed under the terms of this General Public License. The "Program", below, refers to any such program or work, and a "work based on the Program" means either the Program or any derivative work under copyright law: that is to say, a work containing the Program or a portion of it, either verbatim or with modifications and/or translated into another language. (Hereinafter, translation is included without limitation in the term "modification.") Each licensee is addressed as "you".

Activities other than copying, distribution and modification are not covered by this License; they are outside its scope. The act of running the Program is not restricted, and the output from the Program is covered only if its contents constitute a work based on the Program (independent of having been made by running the Program). Whether that is true depends on what the Program does.

1. You may copy and distribute verbatim copies of the Program's source code as you receive it, in any medium, provided that you conspicuously and appropriately publish on each copy an appropriate copyright notice and disclaimer of warranty; keep intact all the notices that refer to this License and to the absence of any warranty; and give any other recipients of the Program a copy of this License along with the Program.

You may charge a fee for the physical act of transferring a copy, and you may at your option offer warranty protection in exchange for a fee.

2. You may modify your copy or copies of the Program or any portion of it, thus forming a work based on the Program, and copy and distribute such modifications or work under the terms of Section 1 above, provided that you also meet all of these conditions:

a) You must cause the modified files to carry prominent notices stating that you changed the files and the date of any change.

b) You must cause any work that you distribute or publish, that in whole or in part contains or is derived from the Program or any part thereof, to be licensed as a whole at no charge to all third parties under the terms of this License.

c) If the modified program normally reads commands interactively when run, you must cause it, when started running for such interactive use in the most ordinary way, to print or display an announcement including an appropriate copyright notice and a notice that there is no warranty (or else, saying that you provide a warranty) and that users may redistribute the program under these conditions, and telling the user how to view a copy of this License. (Exception: if the Program itself is interactive but does not normally print such an announcement, your work based on the Program is not required to print an announcement.)

These requirements apply to the modified work as a whole. If identifiable sections of that work are not derived from the Program, and can be reasonably considered independent and separate works in themselves, then this License, and its terms, do not apply to those sections when you distribute them as separate works. But when you distribute the same sections as part of a whole which is a work based on the Program, the distribution of the whole must be on the terms of this License, whose permissions for other licensees extend to the entire whole, and thus to each and every part regardless of who wrote it.

Thus, it is not the intent of this section to claim rights or contest your rights to work written entirely by you; rather, the intent is to exercise the right to control the distribution of derivative or collective works based on the Program.

In addition, mere aggregation of another work not based on the Program with the Program (or with a work based on the Program) on a volume of a storage or distribution medium does not bring the other work under the scope of this License.

3. You may copy and distribute the Program (or a work based on it, under Section 2) in object code or executable form under the terms of Sections 1 and 2 above provided that you also do one of the following:

a) Accompany it with the complete corresponding machine-readable source code, which must be distributed under the terms of Sections 1 and 2 above on a medium customarily used for software interchange; or,

b) Accompany it with a written offer, valid for at least three years, to give any third party, for a charge no more than your cost of physically performing source distribution, a complete machine-readable copy of the corresponding source code, to be distributed under the terms of Sections 1 and 2 above on a medium customarily used for software interchange; or,

c) Accompany it with the information you received as to the offer to distribute corresponding source code. (This alternative is allowed only for noncommercial distribution and only if you received the program in object code or executable form with such an offer, in accord with Subsection b above.)

The source code for a work means the preferred form of the work for making modifications to it. For an executable work, complete source code means all the source code for all modules it contains, plus any associated interface definition files, plus the scripts used to control compilation and installation of the executable. However, as a special exception, the source code distributed need not include anything that is normally distributed (in either source or binary form) with the major components (compiler, kernel, and so on) of the operating system on which the executable runs, unless that component itself accompanies the executable.

If distribution of executable or object code is made by offering access to copy from a designated place, then offering equivalent access to copy the source code from the same place counts as distribution of the source code, even though third parties are not compelled to copy the source along with the object code.

4. You may not copy, modify, sublicense, or distribute the Program except as expressly provided under this License. Any attempt otherwise to copy, modify, sublicense or distribute the Program is void, and will automatically terminate your rights under this License. However, parties who have received copies, or rights, from you under this License will not have their licenses terminated so long as such parties remain in full compliance.
5. You are not required to accept this License, since you have not signed it. However, nothing else grants you permission to modify or distribute the Program or its derivative works. These actions are prohibited by law if you do not accept this License. Therefore, by modifying or distributing the Program (or any work based on the Program), you indicate your acceptance of this License to do so, and all its terms and conditions for copying, distributing or modifying the Program or works based on it.
6. Each time you redistribute the Program (or any work based on the Program), the recipient automatically receives a license from the original licensor to copy, distribute or modify the Program subject to these terms and conditions. You may not impose any further restrictions on the recipients' exercise of the rights granted herein. You are not responsible for enforcing compliance by third parties to this License.
7. If, as a consequence of a court judgment or allegation of patent infringement or for any other reason (not limited to patent issues), conditions are imposed on you (whether by court order, agreement or otherwise) that contradict the conditions of this License, they do not excuse you from the conditions of this License. If you cannot distribute so as to satisfy simultaneously your obligations under this License and any other pertinent obligations, then as a consequence you may not distribute the Program at all. For example, if a patent license would not permit royalty-free redistribution of the Program by all those who receive copies directly or indirectly through you, then the only way you could satisfy both it and this License would be to refrain entirely from distribution of the Program.

If any portion of this section is held invalid or unenforceable under any particular circumstance, the balance of the section is intended to apply and the section as a whole is intended to apply in other circumstances.

It is not the purpose of this section to induce you to infringe any patents or other property right claims or to contest validity of any such claims; this section has the sole purpose of protecting the integrity of the free software distribution system, which is implemented by public license practices. Many people have made generous contributions to the wide range of software distributed through that system in reliance on consistent application of that system; it is up to the author/donor to decide if he or she is willing to distribute software through any other system and a licensee cannot impose that choice.

This section is intended to make thoroughly clear what is believed to be a consequence of the rest of this License.

8. If the distribution and/or use of the Program is restricted in certain countries either by patents or by copyrighted interfaces, the original copyright holder who places the Program under this License may add an explicit geographical distribution limitation excluding those countries, so that distribution is permitted only in or among countries not thus excluded. In such case, this License incorporates the limitation as if written in the body of this License.
9. The Free Software Foundation may publish revised and/or new versions of the General Public License from time to time. Such new versions will be similar in spirit to the present version, but may differ in detail to address new problems or concerns.

Each version is given a distinguishing version number. If the Program specifies a version number of this License which applies to it and "any later version", you have the option of following the terms and conditions either of that version or of any later version published by the Free Software Foundation. If the Program does not specify a version number of this License, you may choose any version ever published by the Free Software Foundation.
10. If you wish to incorporate parts of the Program into other free programs whose distribution conditions are different, write to the author to ask for permission. For software which is copyrighted by the Free Software Foundation, write to the Free Software Foundation; we sometimes make exceptions for this. Our decision will be guided by the two goals of preserving the free status of all derivatives of our free software and of promoting the sharing and reuse of software generally.

NO WARRANTY

11. BECAUSE THE PROGRAM IS LICENSED FREE OF CHARGE, THERE IS NO WARRANTY FOR THE PROGRAM, TO THE EXTENT PERMITTED BY APPLICABLE LAW. EXCEPT WHEN OTHERWISE STATED IN WRITING THE COPYRIGHT HOLDERS AND/OR OTHER PARTIES PROVIDE THE PROGRAM "AS IS" WITHOUT WARRANTY OF ANY KIND, EITHER EXPRESSED OR IMPLIED, INCLUDING, BUT

NOT LIMITED TO, THE IMPLIED WARRANTIES OF MERCHANTABILITY AND FITNESS FOR A PARTICULAR PURPOSE. THE ENTIRE RISK AS TO THE QUALITY AND PERFORMANCE OF THE PROGRAM IS WITH YOU. SHOULD THE PROGRAM PROVE DEFECTIVE, YOU ASSUME THE COST OF ALL NECESSARY SERVICING, REPAIR OR CORRECTION.

12. IN NO EVENT UNLESS REQUIRED BY APPLICABLE LAW OR AGREED TO IN WRITING WILL ANY COPYRIGHT HOLDER, OR ANY OTHER PARTY WHO MAY MODIFY AND/OR REDISTRIBUTE THE PROGRAM AS PERMITTED ABOVE, BE LIABLE TO YOU FOR DAMAGES, INCLUDING ANY GENERAL, SPECIAL, INCIDENTAL OR CONSEQUENTIAL DAMAGES ARISING OUT OF THE USE OR INABILITY TO USE THE PROGRAM (INCLUDING BUT NOT LIMITED TO LOSS OF DATA OR DATA BEING RENDERED INACCURATE OR LOSSES SUSTAINED BY YOU OR THIRD PARTIES OR A FAILURE OF THE PROGRAM TO OPERATE WITH ANY OTHER PROGRAMS), EVEN IF SUCH HOLDER OR OTHER PARTY HAS BEEN ADVISED OF THE POSSIBILITY OF SUCH DAMAGES.

END OF TERMS AND CONDITIONS

How to Apply These Terms to Your New Programs

If you develop a new program, and you want it to be of the greatest possible use to the public, the best way to achieve this is to make it free software which everyone can redistribute and change under these terms.

To do so, attach the following notices to the program. It is safest to attach them to the start of each source file to most effectively convey the exclusion of warranty; and each file should have at least the "copyright" line and a pointer to where the full notice is found.

<one line to give the program's name and a brief idea of what it does.>
Copyright © <year> <name of author>

This program is free software; you can redistribute it and/or modify it under the terms of the GNU General Public License as published by the Free Software Foundation; either version 2 of the License, or (at your option) any later version.

This program is distributed in the hope that it will be useful, but WITHOUT ANY WARRANTY; without even the implied warranty of MERCHANTABILITY or FITNESS FOR A PARTICULAR PURPOSE. See the GNU General Public License for more details.

You should have received a copy of the GNU General Public License along with this program; if not, write to the Free Software Foundation, Inc., 51 Franklin Street, Fifth Floor, Boston, MA 02110-1301 USA.

Also add information on how to contact you by electronic and paper mail.

If the program is interactive, make it output a short notice like this when it starts in an interactive mode:

Gnomovision version 69, Copyright © year name of author
Gnomovision comes with ABSOLUTELY NO WARRANTY; for details type 'show w'. This is free software, and you are welcome to redistribute it under certain conditions; type 'show c' for details.

The hypothetical commands 'show w' and 'show c' should show the appropriate parts of the General Public License. Of course, the commands you use may be called something other than 'show w' and 'show c'; they could even be mouse-clicks or menu items—whatever suits your program.

You should also get your employer (if you work as a programmer) or your school, if any, to sign a "copyright disclaimer" for the program, if necessary. Here is a sample; alter the names:

Yoyodyne, Inc., hereby disclaims all copyright interest in the program 'Gnomovision' (which makes passes at compilers) written by James Hacker.

<signature of Ty Coon>, 1 April 1989
Ty Coon, President of Vice

This General Public License does not permit incorporating your program into proprietary programs. If your program is a subroutine library, you may consider it more useful to permit linking proprietary applications with the library. If this is what you want to do, use the GNU Lesser General Public License instead of this License.

GNU LESSER GENERAL PUBLIC LICENSE

Version 2.1, February 1999

Copyright © 1991, 1999 Free Software Foundation, Inc., 51 Franklin Street, Fifth Floor, Boston, MA 02110-1301 USA
Everyone is permitted to copy and distribute verbatim copies of this license document, but changing it is not allowed.

[This is the first released version of the Lesser GPL.

It also counts as the successor of the GNU Library Public License, version 2, hence the version number 2.1.]

Preamble

The licenses for most software are designed to take away your freedom to share and change it. By contrast, the GNU General Public Licenses are intended to guarantee your freedom to share and change free software—to make sure the software is free for all its users.

This license, the Lesser General Public License, applies to some specially designated software packages—typically libraries—of the Free Software Foundation and other authors who decide to use it. You can use it too, but we suggest you first think carefully about whether this license or the ordinary General Public License is the better strategy to use in any particular case, based on the explanations below.

When we speak of free software, we are referring to freedom of use, not price. Our General Public Licenses are designed to make sure that you have the freedom to distribute copies of free software (and charge for this service if you wish); that you receive source code or can get it if you want it; that you can change the software and use pieces of it in new free programs; and that you are informed that you can do these things.

To protect your rights, we need to make restrictions that forbid distributors to deny you these rights or to ask you to surrender these rights. These restrictions translate to certain responsibilities for you if you distribute copies of the library or if you modify it.

For example, if you distribute copies of the library, whether gratis or for a fee, you must give the recipients all the rights that we gave you. You must make sure that they, too, receive or can get the source code. If you link other code with the library, you must provide complete object files to the recipients, so that they can relink them with the library after making changes to the library and recompiling it. And you must show them these terms so they know their rights.

We protect your rights with a two-step method: (1) we copyright the library, and (2) we offer you this license, which gives you legal permission to copy, distribute and/or modify the library.

To protect each distributor, we want to make it very clear that there is no warranty for the free library. Also, if the library is modified by someone else and passed on, the recipients should know that what they have is not the original version, so that the original author's reputation will not be affected by problems that might be introduced by others.

Finally, software patents pose a constant threat to the existence of any free program. We wish to make sure that a company cannot effectively restrict the users of a free program by obtaining a restrictive license from a patent holder. Therefore, we insist that any patent license obtained for a version of the library must be consistent with the full freedom of use specified in this license.

Most GNU software, including some libraries, is covered by the ordinary GNU General Public License. This license, the GNU Lesser General Public License, applies to certain designated libraries, and is quite different from the ordinary General Public License. We use this license for certain libraries in order to permit linking those libraries into non-free programs.

When a program is linked with a library, whether statically or using a shared library, the combination of the two is legally speaking a combined work, a derivative of the original library. The ordinary General Public License therefore permits such linking only if the entire combination fits its criteria of freedom. The Lesser General Public License permits more lax criteria for linking other code with the library.

We call this license the “Lesser” General Public License because it does Less to protect the user's freedom than the ordinary General Public License. It also provides other free software developers Less of an advantage over competing non-free programs. These disadvantages are the reason we use the ordinary General Public License for many libraries. However, the Lesser license provides advantages in certain special circumstances.

For example, on rare occasions, there may be a special need to encourage the widest possible use of a certain library, so that it becomes a de-facto standard. To achieve this, non-free programs must be allowed to use the library. A more frequent case is that a free library does the same job as widely used non-free libraries. In this case, there is little to gain by limiting the free library to free software only, so we use the Lesser General Public License.

In other cases, permission to use a particular library in non-free programs enables a greater number of people to use a large body of free software. For example, permission to use the GNU C Library in non-free programs enables many more people to use the whole GNU operating system, as well as its variant, the GNU/Linux operating system.

Although the Lesser General Public License is Less protective of the users' freedom, it does ensure that the user of a program that is linked with the Library has the freedom and the wherewithal to run that program using a modified version of the Library.

The precise terms and conditions for copying, distribution and modification follow. Pay close attention to the difference between a “work based on the library” and a “work that uses the library”. The former contains code derived from the library, whereas the latter must be combined with the library in order to run.

GNU LESSER GENERAL PUBLIC LICENSE TERMS AND CONDITIONS FOR COPYING, DISTRIBUTION AND MODIFICATION

0. This License Agreement applies to any software library or other program which contains a notice placed by the copyright holder or other authorized party saying it may be distributed under the terms of this Lesser General Public License (also called “this License”). Each licensee is addressed as “you”.

A “library” means a collection of software functions and/or data prepared so as to be conveniently linked with application programs (which use some of those functions and data) to form executables.

The “Library”, below, refers to any such software library or work which has been distributed under these terms. A “work based on the Library” means either the Library or any derivative work under copyright law: that is to say, a work containing the Library or a portion of it, either verbatim or with modifications and/or translated straightforwardly into another language. (Hereinafter, translation is included without limitation in the term “modification”.)

“Source code” for a work means the preferred form of the work for making modifications to it. For a library, complete source code means all the source code for all modules it contains, plus any associated interface definition files, plus the scripts used to control compilation and installation of the library.

Activities other than copying, distribution and modification are not covered by this License; they are outside its scope. The act of running a program using the Library is not restricted, and output from such a program is covered only if its contents constitute a work based on the Library (independent of the use of the Library in a tool for writing it). Whether that is true depends on what the Library does and what the program that uses the Library does.

1. You may copy and distribute verbatim copies of the Library's complete source code as you receive it, in any medium, provided that you conspicuously and appropriately publish on each copy an appropriate copyright notice and disclaimer of warranty; keep intact all the notices that refer to this License and to the absence of any warranty; and distribute a copy of this License along with the Library.

You may charge a fee for the physical act of transferring a copy, and you may at your option offer warranty protection in exchange for a fee.

2. You may modify your copy or copies of the Library or any portion of it, thus forming a work based on the Library, and copy and distribute such modifications or work under the terms of Section 1 above, provided that you also meet all of these conditions:
 - a) The modified work must itself be a software library.
 - b) You must cause the files modified to carry prominent notices stating that you changed the files and the date of any change.
 - c) You must cause the whole of the work to be licensed at no charge to all third parties under the terms of this License.

d) If a facility in the modified Library refers to a function or a table of data to be supplied by an application program that uses the facility, other than as an argument passed when the facility is invoked, then you must make a good faith effort to ensure that, in the event an application does not supply such function or table, the facility still operates, and performs whatever part of its purpose remains meaningful.

(For example, a function in a library to compute square roots has a purpose that is entirely well-defined independent of the application. Therefore, Subsection 2d requires that any application-supplied function or table used by this function must be optional: if the application does not supply it, the square root function must still compute square roots.)

These requirements apply to the modified work as a whole. If identifiable sections of that work are not derived from the Library, and can be reasonably considered independent and separate works in themselves, then this License, and its terms, do not apply to those sections when you distribute them as separate works. But when you distribute the same sections as part of a whole which is a work based on the Library, the distribution of the whole must be on the terms of this License, whose permissions for other licensees extend to the entire whole, and thus to each and every part regardless of who wrote it.

Thus, it is not the intent of this section to claim rights or contest your rights to work written entirely by you; rather, the intent is to exercise the right to control the distribution of derivative or collective works based on the Library.

In addition, mere aggregation of another work not based on the Library with the Library (or with a work based on the Library) on a volume of a storage or distribution medium does not bring the other work under the scope of this License.

- 3.** You may opt to apply the terms of the ordinary GNU General Public License instead of this License to a given copy of the Library. To do this, you must alter all the notices that refer to this License, so that they refer to the ordinary GNU General Public License, version 2, instead of to this License. (If a newer version than version 2 of the ordinary GNU General Public License has appeared, then you can specify that version instead if you wish.) Do not make any other change in these notices.

Once this change is made in a given copy, it is irreversible for that copy, so the ordinary GNU General Public License applies to all subsequent copies and derivative works made from that copy.

This option is useful when you wish to copy part of the code of the Library into a program that is not a library.

- 4.** You may copy and distribute the Library (or a portion or derivative of it, under Section 2) in object code or executable form under the terms of Sections 1 and 2 above provided that you accompany it with the complete corresponding machine-readable source code, which must be distributed under the terms of Sections 1 and 2 above on a medium customarily used for software interchange.

If distribution of object code is made by offering access to copy from a designated place, then offering equivalent access to copy the source code from the same place satisfies the requirement to distribute the source code, even though third parties are not compelled to copy the source along with the object code.

- 5.** A program that contains no derivative of any portion of the Library, but is designed to work with the Library by being compiled or linked with it, is called a “work that uses the Library”. Such a work, in isolation, is not a derivative work of the Library, and therefore falls outside the scope of this License.

However, linking a “work that uses the Library” with the Library creates an executable that is a derivative of the Library (because it contains portions of the Library), rather than a “work that uses the library”. The executable is therefore covered by this License. Section 6 states terms for distribution of such executables.

When a “work that uses the Library” uses material from a header file that is part of the Library, the object code for the work may be a derivative work of the Library even though the source code is not. Whether this is true is especially significant if the work can be linked without the Library, or if the work is itself a library. The threshold for this to be true is not precisely defined by law.

If such an object file uses only numerical parameters, data structure layouts and accessors, and small macros and small inline functions (ten lines or less in length), then the use of the object file is unrestricted, regardless of whether it is legally a derivative work. (Executables containing this object code plus portions of the Library will still fall under Section 6.)

Otherwise, if the work is a derivative of the Library, you may distribute the object code for the work under the terms of Section 6. Any

executables containing that work also fall under Section 6, whether or not they are linked directly with the Library itself.

- 6.** As an exception to the Sections above, you may also combine or link a “work that uses the Library” with the Library to produce a work containing portions of the Library, and distribute that work under terms of your choice, provided that the terms permit modification of the work for the customer’s own use and reverse engineering for debugging such modifications.

You must give prominent notice with each copy of the work that the Library is used in it and that the Library and its use are covered by this License. You must supply a copy of this License. If the work during execution displays copyright notices, you must include the copyright notice for the Library among them, as well as a reference directing the user to the copy of this License. Also, you must do one of these things:

a) Accompany the work with the complete corresponding machine-readable source code for the Library including whatever changes were used in the work (which must be distributed under Sections 1 and 2 above); and, if the work is an executable linked with the Library, with the complete machine-readable “work that uses the Library”, as object code and/or source code, so that the user can modify the Library and then relink to produce a modified executable containing the modified Library. (It is understood that the user who changes the contents of definitions files in the Library will not necessarily be able to recompile the application to use the modified definitions.)

b) Use a suitable shared library mechanism for linking with the Library. A suitable mechanism is one that (1) uses at run time a copy of the library already present on the user’s computer system, rather than copying library functions into the executable, and (2) will operate properly with a modified version of the library, if the user installs one, as long as the modified version is interface-compatible with the version that the work was made with.

c) Accompany the work with a written offer, valid for at least three years, to give the same user the materials specified in Subsection 6a, above, for a charge no more than the cost of performing this distribution.

d) If distribution of the work is made by offering access to copy from a designated place, offer equivalent access to copy the above specified materials from the same place.

e) Verify that the user has already received a copy of these materials or that you have already sent this user a copy.

For an executable, the required form of the “work that uses the Library” must include any data and utility programs needed for reproducing the executable from it. However, as a special exception, the materials to be distributed need not include anything that is normally distributed (in either source or binary form) with the major components (compiler, kernel, and so on) of the operating system on which the executable runs, unless that component itself accompanies the executable.

It may happen that this requirement contradicts the license restrictions of other proprietary libraries that do not normally accompany the operating system. Such a contradiction means you cannot use both them and the Library together in an executable that you distribute.

- 7.** You may place library facilities that are a work based on the Library side-by-side in a single library together with other library facilities not covered by this License, and distribute such a combined library, provided that the separate distribution of the work based on the Library and of the other library facilities is otherwise permitted, and provided that you do these two things:

a) Accompany the combined library with a copy of the same work based on the Library, uncombined with any other library facilities. This must be distributed under the terms of the Sections above.

b) Give prominent notice with the combined library of the fact that part of it is a work based on the Library, and explaining where to find the accompanying uncombined form of the same work.

- 8.** You may not copy, modify, sublicense, link with, or distribute the Library except as expressly provided under this License. Any attempt otherwise to copy, modify, sublicense, link with, or distribute the Library is void, and will automatically terminate your rights under this License. However, parties who have received copies, or rights, from you under this License will not have their licenses terminated so long as such parties remain in full compliance.

- 9.** You are not required to accept this License, since you have not signed it. However, nothing else grants you permission to modify or distribute the Library or its derivative works. These actions are prohibited by law if you do not accept this License. Therefore, by modifying or distributing the Library (or any work based on the Library), you indicate your acceptance of this License to do so, and all its terms and conditions for copying, distributing or modifying the Library or works based on it.

10. Each time you redistribute the Library (or any work based on the Library), the recipient automatically receives a license from the original licensor to copy, distribute, link with or modify the Library subject to these terms and conditions. You may not impose any further restrictions on the recipients' exercise of the rights granted herein. You are not responsible for enforcing compliance by third parties with this License.

11. If, as a consequence of a court judgment or allegation of patent infringement or for any other reason (not limited to patent issues), conditions are imposed on you (whether by court order, agreement or otherwise) that contradict the conditions of this License, they do not excuse you from the conditions of this License. If you cannot distribute so as to satisfy simultaneously your obligations under this License and any other pertinent obligations, then as a consequence you may not distribute the Library at all. For example, if a patent license would not permit royalty-free redistribution of the Library by all those who receive copies directly or indirectly through you, then the only way you could satisfy both it and this License would be to refrain entirely from distribution of the Library.

If any portion of this section is held invalid or unenforceable under any particular circumstance, the balance of the section is intended to apply, and the section as a whole is intended to apply in other circumstances.

It is not the purpose of this section to induce you to infringe any patents or other property right claims or to contest validity of any such claims; this section has the sole purpose of protecting the integrity of the free software distribution system which is implemented by public license practices. Many people have made generous contributions to the wide range of software distributed through that system in reliance on consistent application of that system; it is up to the author/donor to decide if he or she is willing to distribute software through any other system and a licensee cannot impose that choice.

This section is intended to make thoroughly clear what is believed to be a consequence of the rest of this License.

12. If the distribution and/or use of the Library is restricted in certain countries either by patents or by copyrighted interfaces, the original copyright holder who places the Library under this License may add an explicit geographical distribution limitation excluding those countries, so that distribution is permitted only in or among countries not thus excluded. In such case, this License incorporates the limitation as if written in the body of this License.

13. The Free Software Foundation may publish revised and/or new versions of the Lesser General Public License from time to time. Such new versions will be similar in spirit to the present version, but may differ in detail to address new problems or concerns.

Each version is given a distinguishing version number. If the Library specifies a version number of this License which applies to it and "any later version", you have the option of following the terms and conditions either of that version or of any later version published by the Free Software Foundation. If the Library does not specify a license version number, you may choose any version ever published by the Free Software Foundation.

14. If you wish to incorporate parts of the Library into other free programs whose distribution conditions are incompatible with these, write to the author to ask for permission. For software which is copyrighted by the Free Software Foundation, write to the Free Software Foundation; we sometimes make exceptions for this. Our decision will be guided by the two goals of preserving the free status of all derivatives of our free software and of promoting the sharing and reuse of software generally.

NO WARRANTY

15. BECAUSE THE LIBRARY IS LICENSED FREE OF CHARGE, THERE IS NO WARRANTY FOR THE LIBRARY, TO THE EXTENT PERMITTED BY APPLICABLE LAW. EXCEPT WHEN OTHERWISE STATED IN WRITING THE COPYRIGHT HOLDERS AND/OR OTHER PARTIES PROVIDE THE LIBRARY "AS IS" WITHOUT WARRANTY OF ANY KIND, EITHER EXPRESSED OR IMPLIED, INCLUDING, BUT NOT LIMITED TO, THE IMPLIED WARRANTIES OF MERCHANTABILITY AND FITNESS FOR A PARTICULAR PURPOSE. THE ENTIRE RISK AS TO THE QUALITY AND PERFORMANCE OF THE LIBRARY IS WITH YOU. SHOULD THE LIBRARY PROVE DEFECTIVE, YOU ASSUME THE COST OF ALL NECESSARY SERVICING, REPAIR OR CORRECTION.

16. IN NO EVENT UNLESS REQUIRED BY APPLICABLE LAW OR AGREED TO IN WRITING WILL ANY COPYRIGHT HOLDER, OR ANY OTHER PARTY WHO MAY MODIFY AND/OR REDISTRIBUTE THE LIBRARY AS PERMITTED ABOVE, BE LIABLE TO YOU FOR DAMAGES, INCLUDING ANY GENERAL, SPECIAL, INCIDENTAL OR CONSEQUENTIAL DAMAGES ARISING OUT OF THE USE OR INABILITY TO USE THE LIBRARY (INCLUDING BUT NOT LIMITED TO LOSS OF DATA OR DATA BEING RENDERED INACCURATE OR

LOSSES SUSTAINED BY YOU OR THIRD PARTIES OR A FAILURE OF THE LIBRARY TO OPERATE WITH ANY OTHER SOFTWARE), EVEN IF SUCH HOLDER OR OTHER PARTY HAS BEEN ADVISED OF THE POSSIBILITY OF SUCH DAMAGES.

END OF TERMS AND CONDITIONS

How to Apply These Terms to Your New Libraries

If you develop a new library, and you want it to be of the greatest possible use to the public, we recommend making it free software that everyone can redistribute and change. You can do so by permitting redistribution under these terms (or, alternatively, under the terms of the ordinary General Public License).

To apply these terms, attach the following notices to the library. It is safest to attach them to the start of each source file to most effectively convey the exclusion of warranty; and each file should have at least the "copyright" line and a pointer to where the full notice is found.

<one line to give the library's name and a brief idea of what it does.>
Copyright © <year> <name of author>

This library is free software; you can redistribute it and/or modify it under the terms of the GNU Lesser General Public License as published by the Free Software Foundation; either version 2.1 of the License, or (at your option) any later version.

This library is distributed in the hope that it will be useful, but WITHOUT ANY WARRANTY; without even the implied warranty of MERCHANTABILITY or FITNESS FOR A PARTICULAR PURPOSE. See the GNU Lesser General Public License for more details.

You should have received a copy of the GNU Lesser General Public License along with this library; if not, write to the Free Software Foundation, Inc., 51 Franklin Street, Fifth Floor, Boston, MA 02110-1301 USA

Also add information on how to contact you by electronic and paper mail.

You should also get your employer (if you work as a programmer) or your school, if any, to sign a "copyright disclaimer" for the library, if necessary. Here is a sample; alter the names:

Yoyodyne, Inc., hereby disclaims all copyright interest in the library 'Frob' (a library for tweaking knobs) written by James Random Hacker.

<signature of Ty Coon>, 1 April 1990
Ty Coon, President of Vice

That's all there is to it!

Note on source code distribution

For three years after the final factory shipment, you may request from Yamaha the source code for any portions of the product which are licensed under the GNU General Public License or GNU Lesser General Public License by writing to one of the Yamaha office addresses listed at the end of this Owner's Manual.

The source code will be provided at no charge; however, we may require you to reimburse Yamaha for the cost of delivering the source code to you.

- Note that we shall bear no responsibility whatsoever for any damage arising from changes (additions/ deletions) made to the software for this product by a third party other than Yamaha (or party authorized by Yamaha).
- Note that re-use of source code released to the public domain by Yamaha is unguaranteed, and Yamaha shall not bear any responsibility whatsoever for the source code.
- The source code can be downloaded from the following address:
<http://download.yamaha.com/sourcecodes/ekb/>

libpng

This copy of the libpng notices is provided for your convenience. In case of any discrepancy between this copy and the notices in the file png.h that is included in the libpng distribution, the latter shall prevail.

COPYRIGHT NOTICE, DISCLAIMER, and LICENSE:

If you modify libpng you may insert additional notices immediately following this sentence.

This code is released under the libpng license.

libpng versions 1.0.7, July 1, 2000 through 1.6.28, January 5, 2017 are Copyright (c) 2000-2002, 2004, 2006-2017 Glenn Randers-Pehrson, are derived from libpng-1.0.6, and are distributed according to the same disclaimer and license as libpng-1.0.6 with the following individuals added to the list of Contributing Authors:

Simon-Pierre Cadieux
Eric S. Raymond
Mans Rullgard
Cosmin Truta
Gilles Vollant
James Yu
Mandar Sahastrabuddhe

and with the following additions to the disclaimer:

There is no warranty against interference with your enjoyment of the library or against infringement. There is no warranty that our efforts or the library will fulfill any of your particular purposes or needs. This library is provided with all faults, and the entire risk of satisfactory quality, performance, accuracy, and effort is with the user.

Some files in the "contrib" directory and some configure-generated files that are distributed with libpng have other copyright owners and are released under other open source licenses.

libpng versions 0.97, January 1998, through 1.0.6, March 20, 2000, are Copyright (c) 1998-2000 Glenn Randers-Pehrson, are derived from libpng-0.96, and are distributed according to the same disclaimer and license as libpng-0.96, with the following individuals added to the list of Contributing Authors:

Tom Lane
Glenn Randers-Pehrson
Willem van Schaik

libpng versions 0.89, June 1996, through 0.96, May 1997, are Copyright (c) 1996-1997 Andreas Dilger, are derived from libpng-0.88, and are distributed according to the same disclaimer and license as libpng-0.88, with the following individuals added to the list of Contributing Authors:

John Bowler
Kevin Bracey
Sam Bushell
Magnus Holmgren
Greg Roelofs
Tom Tanner

Some files in the "scripts" directory have other copyright owners but are released under this license.

libpng versions 0.5, May 1995, through 0.88, January 1996, are Copyright (c) 1995-1996 Guy Eric Schalnat, Group 42, Inc.

For the purposes of this copyright and license, "Contributing Authors" is defined as the following set of individuals:

Andreas Dilger
Dave Martindale
Guy Eric Schalnat
Paul Schmidt
Tim Wegner

The PNG Reference Library is supplied "AS IS". The Contributing Authors and Group 42, Inc. disclaim all warranties, expressed or implied, including, without limitation, the warranties of merchantability and of fitness for any purpose. The Contributing Authors and Group 42, Inc. assume no liability for direct, indirect, incidental, special, exemplary, or consequential damages, which may result from the use of the PNG Reference Library, even if advised of the possibility of such damage.

Permission is hereby granted to use, copy, modify, and distribute this source code, or portions hereof, for any purpose, without fee, subject to the following restrictions:

1. The origin of this source code must not be misrepresented.
2. Altered versions must be plainly marked as such and must not be misrepresented as being the original source.
3. This Copyright notice may not be removed or altered from any source or altered source distribution.

The Contributing Authors and Group 42, Inc. specifically permit, without fee, and encourage the use of this source code as a component to supporting the PNG file format in commercial products. If you use this source code in a product, acknowledgment is not required but would be appreciated.

END OF COPYRIGHT NOTICE, DISCLAIMER, and LICENSE.

TRADEMARK:

The name "libpng" has not been registered by the Copyright owner as a trademark in any jurisdiction. However, because libpng has been distributed and maintained world-wide, continually since 1995, the Copyright owner claims "common-law trademark protection" in any jurisdiction where common-law trademark is recognized.

OSI CERTIFICATION:

Libpng is OSI Certified Open Source Software. OSI Certified Open Source is a certification mark of the Open Source Initiative. OSI has not addressed the additional disclaimers inserted at version 1.0.7.

EXPORT CONTROL:

The Copyright owner believes that the Export Control Classification Number (ECCN) for libpng is EAR99, which means not subject to export controls or International Traffic in Arms Regulations (ITAR) because it is open source, publicly available software, that does not contain any encryption software. See the EAR, paragraphs 734.3(b)(3) and 734.7(b).

Glenn Randers-Pehrson
glennrp at users.sourceforge.net
January 5, 2017

libuuid

Copyright: 1996, 1997, 1998, 1999, 2007 Theodore Ts'o.
1999 Andreas Dilger (adilger@enel.ucalgary.ca)

Redistribution and use in source and binary forms, with or without modification, are permitted provided that the following conditions are met:

1. Redistributions of source code must retain the above copyright notice, and the entire permission notice in its entirety, including the disclaimer of warranties.
2. Redistributions in binary form must reproduce the above copyright notice, this list of conditions and the following disclaimer in the documentation and/or other materials provided with the distribution.
3. The name of the author may not be used to endorse or promote products derived from this software without specific prior written permission.

THIS SOFTWARE IS PROVIDED "AS IS" AND ANY EXPRESS OR IMPLIED WARRANTIES, INCLUDING, BUT NOT LIMITED TO, THE IMPLIED WARRANTIES OF MERCHANTABILITY AND FITNESS FOR A PARTICULAR PURPOSE, ALL OF WHICH ARE HEREBY DISCLAIMED. IN NO EVENT SHALL THE AUTHOR BE LIABLE FOR ANY DIRECT, INDIRECT, INCIDENTAL, SPECIAL, EXEMPLARY, OR CONSEQUENTIAL DAMAGES (INCLUDING, BUT NOT LIMITED TO, PROCUREMENT OF SUBSTITUTE GOODS OR SERVICES; LOSS OF USE, DATA, OR PROFITS; OR BUSINESS INTERRUPTION) HOWEVER CAUSED AND ON ANY THEORY OF LIABILITY, WHETHER IN CONTRACT, STRICT LIABILITY, OR TORT (INCLUDING NEGLIGENCE OR OTHERWISE) ARISING IN ANY WAY OUT OF THE USE OF THIS SOFTWARE, EVEN IF NOT ADVISED OF THE POSSIBILITY OF SUCH DAMAGE.

libjpeg

This software is based in part on the work of the Independent JPEG Group.

imagemagick

Licensed under the ImageMagick License (the "License"); you may not use this file except in compliance with the License. You may obtain a copy of the License at

<https://www.imagemagick.org/script/license.php>

Unless required by applicable law or agreed to in writing, software distributed under the License is distributed on an "AS IS" BASIS, WITHOUT WARRANTIES OR CONDITIONS OF ANY KIND, either express or implied. See the License for the specific language governing permissions and limitations under the License.

FreeType

Portions of this software are copyright © 2016 The FreeType Project (www.freetype.org). All rights reserved.

ICU

COPYRIGHT AND PERMISSION NOTICE

Copyright © 1991-2016 Unicode, Inc. All rights reserved.
Distributed under the Terms of Use in <http://www.unicode.org/copyright.html>.

Permission is hereby granted, free of charge, to any person obtaining a copy of the Unicode data files and any associated documentation (the "Data Files") or Unicode software and any associated documentation (the "Software") to deal in the Data Files or Software without restriction, including without limitation the rights to use, copy, modify, merge, publish, distribute, and/or sell copies of the Data Files or Software, and to permit persons to whom the Data Files or Software are furnished to do so, provided that either (a) this copyright and permission notice appear with all copies of the Data Files or Software, or (b) this copyright and permission notice appear in associated Documentation.

THE DATA FILES AND SOFTWARE ARE PROVIDED "AS IS," WITHOUT WARRANTY OF ANY KIND, EXPRESS OR IMPLIED, INCLUDING BUT NOT LIMITED TO THE WARRANTIES OF MERCHANTABILITY, FITNESS FOR A PARTICULAR PURPOSE AND NON-INFRINGEMENT OF THIRD PARTY RIGHTS.

IN NO EVENT SHALL THE COPYRIGHT HOLDER OR HOLDERS INCLUDED IN THIS NOTICE BE LIABLE FOR ANY CLAIM, OR ANY SPECIAL INDIRECT OR CONSEQUENTIAL DAMAGES, OR ANY DAMAGES WHATSOEVER RESULTING FROM LOSS OF USE, DATA OR PROFITS, WHETHER IN AN ACTION OF CONTRACT, NEGLIGENCE OR OTHER TORTIOUS ACTION, ARISING OUT OF OR IN CONNECTION WITH THE USE OR PERFORMANCE OF THE DATA FILES OR SOFTWARE.

Except as contained in this notice, the name of a copyright holder shall not be used in advertising or otherwise to promote the sale, use or other dealings in these Data Files or Software without prior written authorization of the copyright holder.

jemalloc

Copyright (C) 2002-2014 Jason Evans <jasone@canonware.com>. All rights reserved.
Copyright (C) 2007-2012 Mozilla Foundation. All rights reserved.
Copyright (C) 2009-2014 Facebook, Inc. All rights reserved.

Redistribution and use in source and binary forms, with or without modification, are permitted provided that the following conditions are met:

1. Redistributions of source code must retain the above copyright notice(s), this list of conditions and the following disclaimer.
2. Redistributions in binary form must reproduce the above copyright notice(s), this list of conditions and the following disclaimer in the documentation and/or other materials provided with the distribution.

THIS SOFTWARE IS PROVIDED BY THE COPYRIGHT HOLDER(S) "AS IS" AND ANY EXPRESS OR IMPLIED WARRANTIES, INCLUDING, BUT NOT LIMITED TO, THE IMPLIED WARRANTIES OF MERCHANTABILITY AND FITNESS FOR A PARTICULAR PURPOSE ARE DISCLAIMED. IN NO EVENT SHALL THE COPYRIGHT HOLDER(S) BE LIABLE FOR ANY DIRECT, INDIRECT, INCIDENTAL, SPECIAL, EXEMPLARY, OR CONSEQUENTIAL DAMAGES (INCLUDING, BUT NOT LIMITED TO, PROCUREMENT OF SUBSTITUTE GOODS OR SERVICES; LOSS OF USE, DATA, OR PROFITS; OR BUSINESS INTERRUPTION) HOWEVER CAUSED AND ON ANY THEORY OF LIABILITY, WHETHER IN CONTRACT, STRICT LIABILITY, OR TORT (INCLUDING NEGLIGENCE OR OTHERWISE) ARISING IN ANY WAY OUT OF THE USE OF THIS SOFTWARE, EVEN IF ADVISED OF THE POSSIBILITY OF SUCH DAMAGE.

libss2 / libcomerr2

Copyright 1987, 1988 by the Student Information Processing Board of the Massachusetts Institute of Technology

Permission to use, copy, modify, and distribute this software and its documentation for any purpose and without fee is hereby granted, provided that the above copyright notice appear in all copies and that both that copyright notice and this permission notice appear in supporting documentation, and that the names of M.I.T. and the M.I.T. S.I.P.B. not be used in advertising or publicity pertaining to distribution of the software without specific, written prior permission.

M.I.T. and the M.I.T. S.I.P.B. make no representations about the suitability of this software for any purpose. It is provided "as is" without express or implied warranty.

Important Notice: Guarantee Information for customers in European Economic Area (EEA) and Switzerland

| | |
|---|----------------|
| <p>Important Notice: Guarantee Information for customers in EEA* and Switzerland</p> <p>For detailed guarantee information about this Yamaha product, and Pan-EEA* and Switzerland warranty service, please either visit the website address below (Printable file is available at our website) or contact the Yamaha representative office for your country. * EEA: European Economic Area</p> | English |
| <p>Wichtiger Hinweis: Garantie-Information für Kunden in der EWR* und der Schweiz</p> <p>Für nähere Garantie-Information über dieses Produkt von Yamaha, sowie über den Pan-EWR*- und Schweizer Garantieservice, besuchen Sie bitte entweder die folgend angegebene Internetadresse (eine druckfähige Version befindet sich auch auf unserer Webseite), oder wenden Sie sich an den für Ihr Land zuständigen Yamaha-Vertrieb. *EWR: Europäischer Wirtschaftsraum</p> | Deutsch |
| <p>Remarque importante: informations de garantie pour les clients de l'EEE et la Suisse</p> <p>Pour des informations plus détaillées sur la garantie de ce produit Yamaha et sur le service de garantie applicable dans l'ensemble de l'EEE ainsi qu'en Suisse, consultez notre site Web à l'adresse ci-dessous (le fichier imprimable est disponible sur notre site Web) ou contactez directement Yamaha dans votre pays de résidence. * EEE : Espace Economique Européen</p> | Français |
| <p>Belangrijke mededeling: Garantie-informatie voor klanten in de EER* en Zwitserland</p> <p>Voor gedetailleerde garantie-informatie over dit Yamaha-product en de garantieservice in heel de EER* en Zwitserland, gaat u naar de onderstaande website (u vind een afdrukbaar bestand op onze website) of neemt u contact op met de vertegenwoordiging van Yamaha in uw land. * EER: Europese Economische Ruimte</p> | Nederlands |
| <p>Aviso importante: información sobre la garantía para los clientes del EEE* y Suiza</p> <p>Para una información detallada sobre este producto Yamaha y sobre el soporte de garantía en la zona EEE* y Suiza, visite la dirección web que se incluye más abajo (la versión del archivo para imprimir esta disponible en nuestro sitio web) o póngase en contacto con el representante de Yamaha en su país. * EEE: Espacio Económico Europeo</p> | Español |
| <p>Avviso importante: informazioni sulla garanzia per i clienti residenti nell'EEA* e in Svizzera</p> <p>Per informazioni dettagliate sulla garanzia relativa a questo prodotto Yamaha e l'assistenza in garanzia nei paesi EEA* e in Svizzera, potete consultare il sito Web all'indirizzo riportato di seguito (è disponibile il file in formato stampabile) oppure contattare l'ufficio di rappresentanza locale della Yamaha. * EEA: Area Economica Europea</p> | Italiano |
| <p>Aviso importante: informações sobre as garantias para clientes da AEE* e da Suíça</p> <p>Para obter uma informação pormenorizada sobre este produto da Yamaha e sobre o serviço de garantia na AEE* e na Suíça, visite o site a seguir (o arquivo para impressão está disponível no nosso site) ou entre em contato com o escritório de representação da Yamaha no seu país. * AEE: Área Económica Européia</p> | Português |
| <p>Σημαντική σημείωση: Πληροφορίες εγγύησης για τους πελάτες στον EOX* και Ελβετία</p> <p>Για λεπτομερείς πληροφορίες εγγύησης σχετικά με το παρόν προϊόν της Yamaha και την κάλυψη εγγύησης σε όλες τις χώρες του EOX και την Ελβετία, επισκεφτείτε την παρακάτω ιστοσελίδα (Εκτυπώσιμη μορφή είναι διαθέσιμη στην ιστοσελίδα μας) ή απευθυνθείτε στην αντιπροσωπεία της Yamaha στη χώρα σας. * EOX: Ευρωπαϊκός Οικονομικός Χώρος</p> | Ελληνικά |
| <p>Viktigt: Garantiinformation för kunder i EES-området* och Schweiz</p> <p>För detaljerad information om denna Yamahaprodukt samt garantiservice i hela EES-området* och Schweiz kan du antingen besöka nedanstående webbadress (en utskriftsvänlig fil finns på webbplatsen) eller kontakta Yamahas officiella representant i ditt land. * EES: Europeiska Ekonomiska Samarbetsområdet</p> | Svenska |
| <p>Viktig merknad: Garantiinformasjon for kunder i EØS* og Sveits</p> <p>Detaljert garantiinformasjon om dette Yamaha-produktet og garantiservice for hele EØS-området* og Sveits kan fås enten ved å besøke nettstedene nedenfor (utskriftsversjon finnes på våre nettsider) eller kontakte Yamahas kontoret i landet der du bor. *EØS: Det europeiske økonomiske samarbeidsområdet</p> | Norsk |
| <p>Vigtig oplysning: Garantioplysninger til kunder i EØO* og Schweiz</p> <p>De kan finde detaljerede garantioplysninger om dette Yamaha-produkt og den fælles garantiserviceordning for EØO* (og Schweiz) ved at besøge det websted, der er angivet nedenfor (der findes en fil, som kan udskrives, på vores websted), eller ved at kontakte Yamahas nationale repræsentationskontor i det land, hvor De bor. * EØO: Det Europæiske Økonomiske Område</p> | Dansk |
| <p>Tärkeä ilmoitus: Takuutiedot Euroopan talousalueen (ETA)* ja Sveitsin asiakkaille</p> <p>Tämän Yamaha-tuotteen sekä ETA-alueen ja Sveitsin takuuta koskevat yksityiskohtaiset tiedot saatte alla olevasta nettiosoitteesta. (Tulostettava tiedosto saatavissa sivustollamme.) Voitte myös ottaa yhteyttä paikalliseen Yamaha-edustajaan. *ETA: Euroopan talousalue</p> | Suomi |
| <p>Ważne: Warunki gwarancyjne obowiązujące w EOG* i Szwajcarii</p> <p>Aby dowiedzieć się więcej na temat warunków gwarancyjnych tego produktu firmy Yamaha i serwisu gwarancyjnego w całym EOG* i Szwajcarii, należy odwiedzić wskazaną poniżej stronę internetową (Plik gotowy do wydruku znajduje się na naszej stronie internetowej) lub skontaktować się z przedstawicielstwem firmy Yamaha w swoim kraju. * EOG — Europejski Obszar Gospodarczy</p> | Polski |
| <p>Důležité oznámení: Záruční informace pro zákazníky v EHS* a ve Švýcarsku</p> <p>Podrobné záruční informace o tomto produktu Yamaha a záručním servisu v celém EHS* a ve Švýcarsku naleznete na níže uvedené webové adrese (soubor k tisku je dostupný na našich webových stránkách) nebo se můžete obrátit na zástupce firmy Yamaha ve své zemi. * EHS: Evropský hospodářský prostor</p> | Česky |
| <p>Fontos figyelemzétetés: Garancia-információk az EGT* területén és Svájcban élő vásárlók számára</p> <p>A jelen Yamaha termékre vonatkozó részletes garancia-információk, valamint az EGT*-re és Svájcra kiterjedő garanciális szolgáltatás tekintetében keresse fel webhelyünket az alábbi címen (a webhelyen nyomtatható fájl is talál), vagy pedig lépjen kapcsolatba az országában működő Yamaha képviselői irodával. * EGT: Európai Gazdasági Térség</p> | Magyar |
| <p>Oluline märkus: Garantiiteave Euroopa Majanduspiirkonna (EMP)* ja Šveitsi klientidele</p> <p>Täpsema teabe saamiseks selle Yamaha toote garantii ning kogu Euroopa Majanduspiirkonna ja Šveitsi garantiiteeninduse kohta, külastage palun veebisaiti alljärgneval aadressil (meie saidil on saadaval printitav fail) või pöörduge Teie regiooni Yamaha esinduse poole. * EMP: Euroopa Majanduspiirkond</p> | Eesti keel |
| <p>Svarīgs paziņojums: garantijas informācija klientiem EEZ* un Šveicē</p> <p>Lai saņemtu detalizētu garantijas informāciju par šo Yamaha produktu, kā arī garantijas apkalpošanu EEZ* un Šveicē, lūdzu, apmeklējiet zemāk norādīto tīmekļa vietnes adresi (tīmekļa vietnē ir pieejams drukājams fails) vai sazinieties ar jūsu valsti apkalpojošo Yamaha pārstāvniecību. * EEZ: Eiropas Ekonomikas zona</p> | Latviešu |
| <p>Děmesio: informacija dėl garantijos pirkėjams EEE* ir Šveicarijoje</p> <p>Jei reikia išsamios informacijos apie šį „Yamaha“ produktą ir jo techninę priežiūrą visoje EEE* ir Šveicarijoje, apsilankykite mūsų svetainėje toliau nurodytu adresu (svetainėje yra spausdintinas failas) arba kreipkitės į „Yamaha“ atstovybę savo šalyje. *EEE – Europos ekonominė erdvė</p> | Lietuvių kalba |
| <p>Dôležité upozornenie: Informácie o záruke pre zákazníkov v EHP* a Švajčiarsku</p> <p>Podrobné informácie o záruke týkajúce sa tohto produktu od spoločnosti Yamaha a garančnom servise v EHP* a Švajčiarsku nájdete na webovej stránke uvedenej nižšie (na našej webovej stránke je k dispozícii súbor na tlač) alebo sa obráťte na zástupcu spoločnosti Yamaha vo svojej krajine. * EHP: Európsky hospodársky priestor</p> | Slovenčina |
| <p>Pomembno obvestilo: Informacije o garanciji za kupce v EGP* in Švici</p> <p>Za podrobnejše informacije o tem Yamahinem izdelku ter garancijskem servisu v celotnem EGP in Švici, obiščite spletno mesto, ki je navedeno spodaj (natisljiva datoteka je na voljo na našem spletnem mestu), ali se obrnite na Yamahinega predstavnika v svoji državi. * EGP: Evropski gospodarski prostor</p> | Slovenščina |
| <p>Важно съобщение: Информация за гаранцията за клиенти в ЕИП* и Швейцария</p> <p>За подробна информация за гаранцията за този продукт на Yamaha и гаранционното обслужване в паневропейската зона на ЕИП* и Швейцария или посетете посочения по-долу уеб сайт (на нашия уеб сайт има файл за печат), или се свържете с представителния офис на Yamaha във вашата страна. * ЕИП: Европейско икономическо пространство</p> | Български език |
| <p>Notificare importantă: Informații despre garanție pentru clienții din SEE* și Elveția</p> <p>Pentru informații detaliate privind acest produs Yamaha și serviciul de garanție Pan-SEE* și Elveția, vizitați site-ul la adresa de mai jos (fișierul imprimabil este disponibil pe site-ul nostru) sau contactați biroul reprezentanței Yamaha din țara dumneavoastră. * SEE: Spațiul Economic European</p> | Limba română |

<http://europe.yamaha.com/warranty/>

URL_4



1-YEAR LIMITED WARRANTY ON ARRANGER WORKSTATION KEYBOARDS

Thank you for selecting a YAMAHA product. YAMAHA products are designed and manufactured to provide a high level of defect-free performance. Yamaha Corporation of America ("YAMAHA") is proud of the experience and craftsmanship that goes into each and every YAMAHA product. YAMAHA sells its products through a network of reputable, specially authorized dealers and is pleased to offer you, the Original Owner, the following Limited Warranty, which applies only to products that have been (1) directly purchased from YAMAHA's authorized dealers in the fifty states of the USA and District of Columbia (the "Warranted Area") and (2) used exclusively in the Warranted Area. YAMAHA suggests that you read the Limited Warranty thoroughly, and invites you to contact your authorized YAMAHA dealer or YAMAHA Customer Service if you have any questions.

Coverage: YAMAHA will, at its option, repair or replace the product covered by this warranty if it becomes defective, malfunctions or otherwise fails to conform with this warranty under normal use and service during the term of this warranty, without charge for labor or materials. Repairs may be performed using new or refurbished parts that meet or exceed YAMAHA specifications for new parts. If YAMAHA elects to replace the product, the replacement may be a reconditioned unit. You will be responsible for any installation or removal charges and for any initial shipping charges if the product(s) must be shipped for warranty service. However, YAMAHA will pay the return shipping charges to any destination within the USA if the repairs are covered by the warranty. This warranty does not cover (a) damage, deterioration or malfunction resulting from accident, negligence, misuse, abuse, improper installation or operation or failure to follow instructions according to the Owner's Manual for this product; any shipment of the product (claims must be presented to the carrier); repair or attempted repair by anyone other than YAMAHA or an authorized YAMAHA Service Center; (b) any unit which has been altered or on which the serial number has been defaced, modified or removed; (c) normal wear and any periodic maintenance; (d) deterioration due to perspiration, corrosive atmosphere or other external causes such as extremes in temperature or humidity; (e) damages attributable to power line surge or related electrical abnormalities, lightning damage or acts of God; or (f) RFI/EMI (Interference/noise) caused by improper grounding or the improper use of either certified or uncertified equipment, if applicable. Any evidence of alteration, erasing or forgery of proof-of-purchase documents will cause this warranty to be void. This warranty covers only the Original Owner and is not transferable.

In Order to Obtain Warranty Service: Warranty service will only be provided for defective products within the Warranted Area. Contact your local authorized YAMAHA dealer who will advise you of the procedures to be followed. If this is not successful, contact YAMAHA at the address, telephone number or website shown below. YAMAHA may request that you send the defective product to a local authorized YAMAHA Servicer or authorize return of the defective product to YAMAHA for repair. If you are uncertain as to whether a dealer has been authorized by YAMAHA, please contact YAMAHA's Service Department at the number shown below, or check Yamaha's website at www.Yamaha.com. Product(s) shipped for service should be packed securely and must be accompanied by a detailed explanation of the problem(s) requiring service, together with the original or a machine reproduction of the bill of sale or other dated, proof-of-purchase document describing the product, as evidence of warranty coverage. Should any product submitted for warranty service be found ineligible therefore, an estimate of repair cost will be furnished and the repair will be accomplished only if requested by you and upon receipt of payment or acceptable arrangement for payment.

Limitation of Implied Warranties and Exclusion of Damages: ANY IMPLIED WARRANTIES, INCLUDING WARRANTIES OF MERCHANTABILITY AND FITNESS FOR A PARTICULAR PURPOSE SHALL BE LIMITED IN DURATION TO THE APPLICABLE PERIOD OF TIME SET FORTH ABOVE. YAMAHA SHALL NOT BE RESPONSIBLE FOR INCIDENTAL OR CONSEQUENTIAL DAMAGES OR FOR DAMAGES BASED UPON INCONVENIENCE, LOSS OF USE, DAMAGE TO ANY OTHER EQUIPMENT OR OTHER ITEMS AT THE SITE OF USE OR INTERRUPTION OF PERFORMANCES OR ANY CONSEQUENCES. YAMAHA'S LIABILITY FOR ANY DEFECTIVE PRODUCT IS LIMITED TO REPAIR OR REPLACEMENT OF THE PRODUCT, AT YAMAHA'S OPTION. SOME STATES DO NOT ALLOW LIMITATIONS ON HOW LONG AN IMPLIED WARRANTY LASTS OR THE EXCLUSION OR LIMITATION OF INCIDENTAL OR CONSEQUENTIAL DAMAGES, SO THE ABOVE LIMITATION OR EXCLUSION MAY NOT APPLY TO YOU. This Warranty gives you specific legal rights, and you may also have other rights which vary from state to state. This is the only express warranty applicable to the product specified herein; Yamaha neither assumes nor authorizes anyone to assume for it any other express warranty.

If you have any questions about service received or if you need assistance in locating an authorized YAMAHA Servicer, please contact:



CUSTOMER SERVICE
Yamaha Corporation of America
6600 Orangethorpe Avenue, Buena Park, California 90620-1373
Telephone: 800-854-1569
www.yamaha.com

Do not return any product to the above address without a written Return Authorization issued by YAMAHA.

©2009 Yamaha Corporation of America. Printed in U.S.A.

For EU countries

BG Bulgarian

ОПРОСТЕНА ЕС ДЕКЛАРАЦИЯ ЗА СЪОТВЕТСТВИЕ

С настоящото Yamaha Music Europe GmbH декларира, че този тип радиосъоръжение [Genos] е в съответствие с Директива 2014/53/ЕС. Цялостният текст на ЕС декларацията за съответствие може да се намери на следния интернет адрес:
<https://europe.yamaha.com/en/support/compliance/doc.html>

ES Spanish

DECLARACIÓN UE DE CONFORMIDAD SIMPLIFICADA

Por la presente, Yamaha Music Europe GmbH declara que el tipo de equipo radioeléctrico [Genos] es conforme con la Directiva 2014/53/UE. El texto completo de la declaración UE de conformidad está disponible en la dirección Internet siguiente:
<https://europe.yamaha.com/en/support/compliance/doc.html>

CS Czech

ZJEDNODUŠENÉ EU PROHLÁŠENÍ O SHODĚ

Tímto Yamaha Music Europe GmbH prohlašuje, že typ rádiového zařízení [Genos] je v souladu se směrnicí 2014/53/EU. Úplné znění EU prohlášení o shodě je k dispozici na této internetové adrese:
<https://europe.yamaha.com/en/support/compliance/doc.html>

DA Danish

FORENKLET EU-OVERENSSTEMMELSESERKLÆRING

Herved erklærer Yamaha Music Europe GmbH, at radioudstyrstypen [Genos] er i overensstemmelse med direktiv 2014/53/EU. EU-overensstemmelsestestens fulde tekst kan findes på følgende internetadresse:
<https://europe.yamaha.com/en/support/compliance/doc.html>

DE German

VEREINFACHTE EU-KONFORMITÄTSERKLÄRUNG

Hiermit erklärt Yamaha Music Europe GmbH, dass der Funkanlagentyp [Genos] der Richtlinie 2014/53/EU entspricht. Der vollständige Text der EU-Konformitätserklärung ist unter der folgenden Internetadresse verfügbar:
<https://europe.yamaha.com/en/support/compliance/doc.html>

ET Estonian

LIHTSUSTATUD ELI VASTAVUSDEKLARATSIOON

Käesolevaga deklareerib Yamaha Music Europe GmbH, et käesolev raadioseadme tüüp [Genos] vastab direktiivi 2014/53/EL nõuetele. ELi vastavusdeklaratsiooni täielik tekst on kättesaadav järgmisel internetiaadressil:
<https://europe.yamaha.com/en/support/compliance/doc.html>

EL Greek

ΑΠΛΟΥΣΤΕΥΜΕΝΗ ΔΗΛΩΣΗ ΣΥΜΜΟΡΦΩΣΗΣ ΕΕ

Με την παρούσα ο/η Yamaha Music Europe GmbH, δηλώνει ότι ο ραδιοεξοπλισμός [Genos] πληροί την οδηγία 2014/53/ΕΕ. Το πλήρες κείμενο της δήλωσης συμμόρφωσης ΕΕ διατίθεται στην ακόλουθη ιστοσελίδα στο διαδίκτυο:
<https://europe.yamaha.com/en/support/compliance/doc.html>

EN English

SIMPLIFIED EU DECLARATION OF CONFORMITY

Hereby, Yamaha Music Europe GmbH declares that the radio equipment type [Genos] is in compliance with Directive 2014/53/EU. The full text of the EU declaration of conformity is available at the following internet address:
<https://europe.yamaha.com/en/support/compliance/doc.html>

FR French

DECLARATION UE DE CONFORMITE SIMPLIFIEE

Le soussigné, Yamaha Music Europe GmbH, déclare que l'équipement radioélectrique du type [Genos] est conforme à la directive 2014/53/UE. Le texte complet de la déclaration UE de conformité est disponible à l'adresse internet suivante:
<https://europe.yamaha.com/en/support/compliance/doc.html>

HR Croatian

POJEDNOSTAVLJENA EU IZJAVA O SUKLADNOSTI

Yamaha Music Europe GmbH ovime izjavljuje da je radijska oprema tipa [Genos] u skladu s Direktivom 2014/53/EU. Cjeloviti tekst EU izjave o sukladnosti dostupan je na sljedećoj internetskoj adresi:
<https://europe.yamaha.com/en/support/compliance/doc.html>

IT Italian

DICHIARAZIONE DI CONFORMITÀ UE SEMPLIFICATA

Il fabbricante, Yamaha Music Europe GmbH, dichiara che il tipo di apparecchiatura radio [Genos] è conforme alla direttiva 2014/53/UE. Il testo completo della dichiarazione di conformità UE è disponibile al seguente indirizzo Internet:
<https://europe.yamaha.com/en/support/compliance/doc.html>

LV Latvian

VIENTĀRŠOTA ES ATBILSTĪBAS DEKLARĀCIJA

Ar šo Yamaha Music Europe GmbH deklarē, ka radioiekārta [Genos] atbilst Direktīvai 2014/53/ES. Pilns ES atbilstības deklarācijas teksts ir pieejams šādā interneta vietnē:
<https://europe.yamaha.com/en/support/compliance/doc.html>

LT Lithuanian

SUPAPRASTINTA ES ATITIKTIES DEKLARACIJA

Aš, Yamaha Music Europe GmbH, patvirtinu, kad radijo įrenginių tipas [Genos] atitinka Direktyvą 2014/53/ES. Visas ES atitikties deklaracijos tekstas prieinamas šiuo interneto adresu:
<https://europe.yamaha.com/en/support/compliance/doc.html>

HU Hungarian

EGYSZERŰSÍTETT EU-MEGFELELŐSÉGI NYILATKOZAT

Yamaha Music Europe GmbH igazolja, hogy a [Genos] típusú rádióberendezés megfelel a 2014/53/EU irányelvnek. Az EU-megfelelőségi nyilatkozat teljes szövege elérhető a következő internetes címen:
<https://europe.yamaha.com/en/support/compliance/doc.html>

NL Dutch

VEREENVOUDIGDE EU-CONFORMITEITSVERKLARING

Hierbij verklaar ik, Yamaha Music Europe GmbH, dat het type radioapparatuur [Genos] conform is met Richtlijn 2014/53/EU. De volledige tekst van de EU-conformiteitsverklaring kan worden geraadpleegd op het volgende internetadres:
<https://europe.yamaha.com/en/support/compliance/doc.html>

PL Polish

UPROSZCZONA DEKLARACJA ZGODNOŚCI UE

Yamaha Music Europe GmbH niniejszym oświadcza, że typ urządzenia radiowego [Genos] jest zgodny z dyrektywą 2014/53/UE. Pełny tekst deklaracji zgodności UE jest dostępny pod następującym adresem internetowym:
<https://europe.yamaha.com/en/support/compliance/doc.html>

PT Portuguese

DECLARAÇÃO UE DE CONFORMIDADE SIMPLIFICADA

O(a) abaixo assinado(a) Yamaha Music Europe GmbH declara que o presente tipo de equipamento de rádio [Genos] está em conformidade com a Diretiva 2014/53/UE. O texto integral da declaração de conformidade está disponível no seguinte endereço de Internet:
<https://europe.yamaha.com/en/support/compliance/doc.html>

RO Romanian

DECLARAȚIA UE DE CONFORMITATE SIMPLIFICATĂ

Prin prezenta, Yamaha Music Europe GmbH declară că tipul de echipament radio [Genos] este în conformitate cu Directiva 2014/53/UE. Textul integral al declarației UE de conformitate este disponibil la următoarea adresă internet:
<https://europe.yamaha.com/en/support/compliance/doc.html>

SK Slovak

ZJEDNODUŠENÉ EÚ VYHLÁSENIE O ZHODE

Yamaha Music Europe GmbH týmto vyhlasuje, že rádiové zariadenie typu [Genos] je v súlade so smernicou 2014/53/EÚ. Úplné vyhlásenie o zhode je k dispozícii na tejto internetovej adrese:
<https://europe.yamaha.com/en/support/compliance/doc.html>

SL Slovenian

POENOSTAVLJENA IZJAVA EU O SKLADNOSTI

Yamaha Music Europe GmbH potrjuje, da je tip radijske opreme [Genos] skladen z Direktivo 2014/53/EU. Celotno besedilo izjave EU o skladnosti je na voljo na naslednjem spletnem naslovu:
<https://europe.yamaha.com/en/support/compliance/doc.html>

FI Finnish

YKSINKERTAISTETTU EU-VAATIMUSTENMUKAISUUSVAKUUTUS

Yamaha Music Europe GmbH vakuuttaa, että radiolaitetyypin [Genos] on direktiivin 2014/53/EU mukainen. EU-vaatimustenmukaisuusvakuutuksen täysimittainen teksti on saatavilla seuraavassa internetosoitteessa:
<https://europe.yamaha.com/en/support/compliance/doc.html>

SV Swedish

FÖRENKLAD EU-FÖRSÄKRAN OM ÖVERENSSTÄMMELSE

Härmed försäkras Yamaha Music Europe GmbH att denna typ av radioutrustning [Genos] överensstämmer med direktiv 2014/53/EU. Den fullständiga texten till EU-försäkran om överensstämmelse finns på följande webbadress:
<https://europe.yamaha.com/en/support/compliance/doc.html>

TR Turkey

BASİTLEŞTİRİLMİŞ AVRUPA BİRLİĞİ UYGUNLUK BİLDİRİMİ

İşbu belge ile, Yamaha Music Europe GmbH, radyo cihaz tipinin [Genos], Direktif 2014/53/AB'ye uygunluğunu beyan eder. AB uyumu beyanının tam metni aşağıdaki internet adresinden edinilebilir:
<https://europe.yamaha.com/en/support/compliance/doc.html>



For details of products, please contact your nearest Yamaha representative or the authorized distributor listed below.

Pour plus de détails sur les produits, veuillez-vous adresser à Yamaha ou au distributeur le plus proche de vous figurant dans la liste suivante.

Die Einzelheiten zu Produkten sind bei Ihrer unten aufgeführten Niederlassung und bei Yamaha Vertragshändlern in den jeweiligen Bestimmungsländern erhältlich.

Para detalles sobre productos, contacte su tienda Yamaha más cercana o el distribuidor autorizado que se lista debajo.

NORTH AMERICA

CANADA

Yamaha Canada Music Ltd.
135 Milner Avenue, Toronto, Ontario M1S 3R1,
Canada
Tel: +1-416-298-1311

U.S.A.

Yamaha Corporation of America
6600 Orangethorpe Avenue, Buena Park, CA 90620,
U.S.A.
Tel: +1-714-522-9011

CENTRAL & SOUTH AMERICA

MEXICO

Yamaha de México, S.A. de C.V.
Av. Insurgentes Sur 1647 Piso 9, Col. San José
Insurgentes, Delegación Benito Juárez, México,
D.F., C.P. 03900, México
Tel: +52-55-5804-0600

BRAZIL

Yamaha Musical do Brasil Ltda.
Rua Fidêncio Ramos, 302 – Cj 52 e 54 – Torre B –
Vila Olímpia – CEP 04551-010 – São Paulo/SP,
Brazil
Tel: +55-11-3704-1377

ARGENTINA

**Yamaha Music Latin America, S.A.,
Sucursal Argentina**
Olga Cossetini 1553, Piso 4 Norte,
Madero Este-C1107CEK,
Buenos Aires, Argentina
Tel: +54-11-4119-7000

PANAMA AND OTHER LATIN AMERICAN COUNTRIES/ CARIBBEAN COUNTRIES

Yamaha Music Latin America, S.A.
Edif. Torre Banco General, F7, Urb. Marbella,
Calle 47 y Aquilino de la Guardia, Panama,
P.O.Box 0823-05863, Panama, Rep.de Panama
Tel: +507-269-5311

EUROPE

THE UNITED KINGDOM/IRELAND

Yamaha Music Europe GmbH (UK)
Sherbourne Drive, Tilbrook, Milton Keynes,
MK7 8BL, U.K.
Tel: +44-1908-366700

GERMANY

Yamaha Music Europe GmbH
Siemensstrasse 22-34, 25462 Rellingen, Germany
Tel: +49-4101-303-0

SWITZERLAND/LIECHTENSTEIN

**Yamaha Music Europe GmbH, Branch
Switzerland in Thalwil**
Seestrasse 18a, 8800 Thalwil, Switzerland
Tel: +41-44-3878080

AUSTRIA/CROATIA/CZECH REPUBLIC/ HUNGARY/ROMANIA/SLOVAKIA/ SLOVENIA

Yamaha Music Europe GmbH, Branch Austria
Schleiergasse 20, 1100 Wien, Austria
Tel: +43-1-60203900

POLAND

**Yamaha Music Europe GmbH
Sp.z o.o. Oddział w Polsce**
ul. Wielicka 52, 02-657 Warszawa, Poland
Tel: +48-22-880-08-88

BULGARIA

Dinacord Bulgaria LTD.
Bul. Iskarsko Schose 7 Targowski Zentar Ewropa
1528 Sofia, Bulgaria
Tel: +359-2-978-20-25

MALTA

Olimpus Music Ltd.
Valletta Road, Mosta MST9010, Malta
Tel: +356-2133-2093

NETHERLANDS/BELGIUM/ LUXEMBOURG

Yamaha Music Europe, Branch Benelux
Clarissenhof 5b, 4133 AB Vianen, The Netherlands
Tel: +31-347-358040

FRANCE

Yamaha Music Europe
7 rue Ambroise Croizat, Zone d'activités de Pariest,
77183 Croissy-Beaubourg, France
Tel: +33-1-6461-4000

ITALY

Yamaha Music Europe GmbH, Branch Italy
Via Tinelli N.67/69 20855 Gerno di Lesmo (MB),
Italy
Tel: +39-039-9065-1

SPAIN/PORTUGAL

**Yamaha Music Europe GmbH Ibérica, Sucursal
en España**
Ctra. de la Coruña km. 17,200, 28231
Las Rozas de Madrid, Spain
Tel: +34-91-639-88-88

GREECE

Philippos Nakas S.A. The Music House
19th km. Leof. Lavriou 190 02 Peania – Attiki,
Greece
Tel: +30-210-6686260

SWEDEN

**Yamaha Music Europe GmbH Germany filial
Scandinavia**
JA Wettergrensgata 1, 400 43 Göteborg, Sweden
Tel: +46-31-89-34-00

DENMARK

**Yamaha Music Denmark,
Filiál of Yamaha Music Europe GmbH, Tyskland**
Generatorvej 8C, ST. TH., 2860 Søborg, Denmark
Tel: +45-44-92-49-00

FINLAND

F-Musiikki Oy
Antaksentie 4
FI-01510 Vantaa, Finland
Tel: +358 (0)96185111

NORWAY

**Yamaha Music Europe GmbH Germany -
Norwegian Branch**
Grini Næringspark 1, 1332 Østerås, Norway
Tel: +47-6716-7800

ICELAND

Hljóðfaerahusid Ehf.
Sidumula 20
IS-108 Reykjavik, Iceland
Tel: +354-525-5050

CYPRUS

Nakas Music Cyprus Ltd.
Nikis Ave 2k
1086 Nicosia
Tel: + 357-22-511080
Major Music Center
21 Ali Riza Ave. Ortakoy
P.O.Box 475 Lefkoşa, Cyprus
Tel: (392) 227 9213

RUSSIA

Yamaha Music (Russia) LLC.
Room 37, entrance 7, bld. 7, Kievskaya street,
Moscow, 121059, Russia
Tel: +7-495-626-5005

OTHER EUROPEAN COUNTRIES

Yamaha Music Europe GmbH
Siemensstrasse 22-34, 25462 Rellingen, Germany
Tel: +49-4101-303-0

AFRICA

Yamaha Music Gulf FZE
JAFZA-16, Office 512, P.O.Box 17328,
Jebel Ali FZE, Dubai, UAE
Tel: +971-4-801-1500

MIDDLE EAST

TURKEY

**Yamaha Music Europe GmbH
Merkezi Almanya Türkiye İstanbul Şubesi**
Maslak Meydan Sokak, Spring Giz Plaza Bagimsiz
Böl. No:3, Sariyer Istanbul, Turkey
Tel: +90-212-999-8010

ISRAEL

RBX International Co., Ltd.
P.O.Box 10245, Petach-Tikva, 49002
Tel: (972) 3-925-6900

OTHER COUNTRIES

Yamaha Music Gulf FZE
JAFZA-16, Office 512, P.O.Box 17328,
Jebel Ali FZE, Dubai, UAE
Tel: +971-4-801-1500

ASIA

THE PEOPLE'S REPUBLIC OF CHINA

Yamaha Music & Electronics (China) Co., Ltd.
2F, Yunhedasha, 1818 Xinzha-lu, Jingan-qu,
Shanghai, China
Tel: +86-400-051-7700

HONG KONG

Tom Lee Music Co., Ltd.
11/F., Silvercord Tower 1, 30 Canton Road,
Tsimshatsui, Kowloon, Hong Kong
Tel: +852-2737-7688

INDIA

Yamaha Music India Private Limited
P-401, JMD Megapolis, Sector-48, Sohna Road,
Gurgaon-122018, Haryana, India
Tel: +91-124-485-3300

INDONESIA

PT. Yamaha Musik Indonesia (Distributor)
Yamaha Music Center Bldg. Jalan Jend. Gatot
Subroto Kav. 4, Jakarta 12930, Indonesia
Tel: +62-21-520-2577

KOREA

Yamaha Music Korea Ltd.
8F, Dongsung Bldg. 21, Teheran-ro 87-gil,
Gangnam-gu, Seoul, 06169, Korea
Tel: +82-2-3467-3300

MALAYSIA

Yamaha Music (Malaysia) Sdn. Bhd.
No.8, Jalan Perbandaran, Kelana Jaya, 47301
Petaling Jaya, Selangor, Malaysia
Tel: +60-3-78030900

SINGAPORE

Yamaha Music (Asia) Private Limited
Block 202 Hougang Street 21, #02-00,
Singapore 530202, Singapore
Tel: +65-6740-9200

TAIWAN

Yamaha Music & Electronics Taiwan Co., Ltd.
2F., No.1, Yuanhong Rd., Banqiao Dist.,
New Taipei City 22063, Taiwan (R.O.C.)
Tel: +886-2-7741-8888

THAILAND

Siam Music Yamaha Co., Ltd.
3, 4, 15, 16th Fl., Siam Motors Building,
891/1 Rama 1 Road, Wangmai,
Pathumwan, Bangkok 10330, Thailand
Tel: +66-2215-2622

VIETNAM

Yamaha Music Vietnam Company Limited
15th Floor, Nam A Bank Tower, 201-203 Cach
Mang Thang Tam St., Ward 4, Dist.3,
Ho Chi Minh City, Vietnam
Tel: +84-28-3818-1122

OTHER ASIAN COUNTRIES

<http://asia.yamaha.com>

OCEANIA

AUSTRALIA

Yamaha Music Australia Pty. Ltd.
Level 1, 80 Market Street, South Melbourne,
VIC 3205 Australia
Tel: +61-3-9693-5111

NEW ZEALAND

Music Works LTD
P.O.BOX 6246 Wellesley, Auckland 4680,
New Zealand
Tel: +64-9-634-0099

COUNTRIES AND TRUST

TERRITORIES IN PACIFIC OCEAN
<http://asia.yamaha.com>

Yamaha Global Site
<https://www.yamaha.com/>
Yamaha Downloads
<http://download.yamaha.com/>

Manual Development Group
© 2017 Yamaha Corporation

Published 02/2018 POAP*.*- **D0

ZW77440